

## TÜV RHEINLAND ENERGY GMBH



Report on the performance test of the MP101M ambient air quality measuring system for suspended particulate matter PM<sub>10</sub> manufactured by ENVEA,

TÜV Report: 936/21240384/C  
Cologne, 15 August 2019

[www.umwelt-tuv.de](http://www.umwelt-tuv.de)



[tre-service@de.tuv.com](mailto:tre-service@de.tuv.com)

**TÜV Rheinland Energy GmbH and its Ambient Air Quality department in particular**  
is accredited for the following activities:

- Determination of emissions and ambient air quality affected by air pollutants and odorous substances;
- Inspection of correct installation, function and calibration of continuously operating emission measuring instruments, including data evaluation and remote emission monitoring systems;
- Measurements in combustion chambers;
- Performance testing of measuring systems for continuous monitoring of emissions and ambient air, and of electronic data evaluation and remote emission monitoring systems;
- Determination of the stack height and air quality forecasts for hazardous and odorous substances;
- Determination of emissions and ambient air quality affected by noise and vibration, determination of sound power levels and noise measurements at wind turbines;

**according to EN ISO/IEC 17025.**

The accreditation will expire on 10-12-2022 and covers the scope specified in the annex to certificate D-PL-11120-02-00.

Reproduction of extracts from this test report is subject to prior written consent.

**TÜV Rheinland Energy GmbH**  
**D - 51105 Köln, Am Grauen Stein,**  
**Tel: + 49 (0) 221 806-5200, fax: +49 (0) 221 806-1349**

**Blank page**

## Summary Overview

ENVEA located in Poissy, France, commissioned TÜV Rheinland Energy GmbH to carry out performance testing of the MP101M measuring system for suspended particulate matter PM<sub>10</sub> in accordance with the following standards:

- Standard EN 16450 “Ambient air – Automated measuring systems for the measurement of the concentration of particulate matter (PM<sub>10</sub>; PM<sub>2.5</sub>, German version dated July 2017)
- VDI Standard 4202, part 3, “Automated measuring systems for air quality monitoring Performance test, declaration of suitability and certification of measuring systems for point-related measurement of mass concentration for particulate air pollutants”, February 2019
- European standard EN 12341, “Ambient air - Standard gravimetric measurement method for the determination of the PM<sub>10</sub> or PM<sub>2.5</sub> mass concentration of suspended particulate matter”; German version EN 12341:2014
- Guideline “Demonstration of Equivalence of Ambient Air Monitoring Methods”, English version dated January 2010

During the test, both instruments were also equipped with what is referred to as a CPM+ module. This CPM+ module is an additional optical scattered light sensor for the determination of PM<sub>2.5</sub>. The CPM+ module is mounted directly to the central unit of the sampling tube. The sample stream is passed straight through the CPM+ module to the MP101M analyser without deflection from the sampling tube. The certification does not cover the CPM+ module, as the requirements of EN 16450 could not be fulfilled here. Additional field tests were performed to show that the CPM+ optical measuring module for PM<sub>2.5</sub> has no influence on the radiometric determination of PM<sub>10</sub>.

The MP101M measuring system determines dust concentrations using beta attenuation as its measuring principle. A pump sucks in ambient air via a PM<sub>10</sub> pre-separator. The air is then transported to the measuring system via a sampling tube. The sampling tube contains a heater to avoid condensation effects. Inside the instrument, particles are separated onto a filter tape. A radiometric measurement determines the filter load once an hour.

The tests were performed in the laboratory and in a seventeen-months long field test.

The several-months long field test was performed at the sites listed in Table 1.

Table 1: Description of the test sites

	Cologne (parking lot) Winter	Bonn-Belderberg (summer)	(Cologne) Bulk handling, Summer	(Cologne) Bulk handling, Winter
Period	12/2017 – 03/2018	04/2018 – 06/2018	07/2018 – 11/2018	12/2018 – 02/2019
Number of measurement pairs: Test specimens	57	40	66	45
Description	Urban background	Affected by traffic	Industrial back-ground	Industrial back-ground
Classification of ambient air pollution	low to high	average	average to high	average to high

The following table provides an overview of the equivalence tests performed.

Table 2: Results of equivalent testing (raw data)

Comparison campaigns		Slope	Axis intercept	All Data sets $W_{CM}<25\%$ Raw data	Calibration yes/no	All Data sets $W_{CM}<25\%$ cal. Data
4	Cyc.	1.027	-0.859	yes	yes *	yes
	Per.	1.029	-0.882	yes	yes *	yes

\* Calibration required due to significant axis intercept determined for system 1





Report on the performance test of the MP101M ambient air quality measuring system for suspended particulate matter PM<sub>10</sub> manufactured by ENVEA,

<b>AMS designation:</b>	MP101M
<b>Manufacturer:</b>	ENVEA 111, Bd Robespierre 78304 Poissy Cedex 4 France
<b>Test period:</b>	07.2017 to 06.2019
<b>Date of report:</b>	15 August 2019
<b>Report Number:</b>	936/21240384/C
<b>Editor:</b>	Fritz Hausberg
<b>Technical supervisor:</b>	Guido Baum
<b>Scope of the report:</b>	Report: 98 pages Appendix pp. 99 Manual pp. 125 Manual 192 pages Total 324 pages

**Blank page**

## Table of contents

SUMMARY OVERVIEW .....	3
1. GENERAL.....	11
1.1 Certification proposal .....	11
1.2 Summary report on test results .....	12
2. TASK DEFINITION .....	15
2.1 Nature of the test .....	15
2.2 Objectives .....	15
3. DESCRIPTION OF THE AMS TESTED .....	16
3.1 Measuring principle.....	16
3.2 Functioning of the measuring system.....	16
3.3 AMS scope and set-up.....	19
4. TEST PROGRAMME .....	21
4.1. General.....	21
4.2 Laboratory test.....	21
4.3 Field test.....	22
5. REFERENCE MEASUREMENT METHOD .....	30
6. TEST RESULTS .....	31
6.1 1 Measuring ranges .....	31
6.1 2 negative signals .....	32
6.1 3 Zero level and detection limit (7.4.3) .....	33
6.1 4 Flow rate accuracy (7.4.4).....	35
6.1 5 Constancy of sample flow rate (7.4.5) .....	37
6.1 6 Leak tightness of the sampling system (7.4.6).....	40
6.1 7 Dependence of measured value on surrounding temperature (7.4.7).....	42
6.1 8 Dependence of measured value (span) on surrounding temperature (7.4.7).....	44
6.1 9 Dependence of span on supply voltage (7.4.8) .....	46
6.1 10 Effect of failure of mains voltage .....	48
6.1 11 Dependence of reading on water vapour concentration (7.4.9) .....	49
6.1 12 Zero checks (7.5.3) .....	51
6.1 13 Recording of operational parameters (7.5.4) .....	53
6.1 14 Daily averages (7.5.5) .....	55
6.1 15 Availability (7.5.6).....	56
6.1 Method used for equivalence testing (7.5.8.4 & 7.5.8.8).....	58
6.1 16 Between-AMS uncertainty (7.5.8.4).....	59
6.1 17 Expanded uncertainty (7.5.8.5 – 7.5.8.8).....	67
6.1 17 Use of correction factors/terms (7.5.8.5–7.5.8.8).....	86
6.1 18 Maintenance interval (7.5.7).....	93
6.1 20 Checks of temperature sensors, pressure and/or humidity sensors .....	95
7. RECOMMENDATIONS FOR USE IN PRACTICE.....	96
8. BIBLIOGRAPHY .....	98
9. APPENDIX.....	99

## List of tables

Table 1:	Description of the test sites	4
Table 2:	Results of equivalent testing (raw data)	4
Table 3:	Field test sites	23
Table 4:	Ambient condition at the field test sites (Germany) as daily averages	28
Table 5:	Filter materials used	29
Table 6:	Zero level and detection limit PM <sub>10</sub> , Cyc.	34
Table 7:	Zero level and detection limit PM <sub>10</sub> , Per.	34
Table 8:	Flow rate accuracy at +5 °C and +40 °C	36
Table 9:	Results of flow rate checks at the end of the field test (instantaneous values)	38
Table 10:	Performance characteristics for the overall flow rate measurement (daily average)	38
Table 11:	Results of the leak tests obtained during the field tests at the beginning of each campaign	41
Table 12:	Dependence of the zero point on the surrounding temperature, deviation in µg/m <sup>3</sup> , average of measurements, cyc.	43
Table 13:	Dependence of the zero point on the surrounding temperature, deviation in µg/m <sup>3</sup> , average of measurements, per.	43
Table 14:	Dependence of measured value on surrounding temperature, deviation in %, average from three measurements	45
Table 15:	Influence of mains voltage on measured value, deviation in %	47
Table 16:	Dependence of reading on water vapour concentration, deviations in µg/m <sup>3</sup> , cyc.	50
Table 17:	Dependence of reading on water vapour concentration, deviations in µg/m <sup>3</sup> , per.	50
Table 18:	Zero checks, Cyc.	51
Table 19:	Zero checks, Per.	52
Table 20:	Determination of the availability	57
Table 21:	Between-AMS uncertainty $u_{bs,AMS}$ .	60
Table 22:	Overview of equivalence testing, cyc.	69
Table 23:	Overview of equivalence testing, per.	71
Table 24:	Between RM uncertainty $u_{bs,RM}$	73
Table 25:	Summary of equivalence test results after intercept correction (cyc)	89
Table 26:	Summary of equivalence test results after intercept correction (per)	91

## List of figures

Figure 1:	View of the MP101M .....	16
Figure 2:	Front view of the MP101M (open) .....	17
Figure 3:	Functional diagramme MP101M .....	18
Figure 4:	Sampling (1) PM <sub>10</sub> sampling head (2) weather sensor, (3) sample line, (4) roof bushing, (5) sample line inside.....	19
Figure 5:	MP101M measuring systems on the measuring station (bulk handling) .....	20
Figure 6:	PM <sub>10</sub> concentrations (reference) in “Cologne, winter” .....	24
Figure 7:	PM <sub>10</sub> concentrations (reference) in “Bonn-Belderberg” .....	24
Figure 8:	PM <sub>10</sub> concentrations (reference) in “Bulk handling, summer” .....	25
Figure 9:	PM <sub>10</sub> concentrations (reference) in “Bulk handling, winter” .....	25
Figure 10:	Field test site Cologne, winter .....	26
Figure 11:	Field test site in Bonn-Belderberg.....	26
Figure 12:	Field test site in Cologne, bulk handling, summer + winter .....	27
Figure 13:	Flow rate of tested instrument SN 6158 .....	39
Figure 14:	Flow rate of tested instrument SN 6159 .....	39
Figure 15:	Results of the parallel measurements, all sites, Cyc.....	61
Figure 16:	Results of the parallel measurements, Cologne, winter, Cyc.....	61
Figure 17:	Results of the parallel measurements, Bonn-Belderberg, Cyc.....	62
Figure 18:	Results of the parallel measurements, bulk handling, summer, Cyc.....	62
Figure 19:	Results of the parallel measurements, bulk handling, winter, Cyc.....	63
Figure 20:	Results of the parallel measurements, all sites, values $\geq 30 \mu\text{g}/\text{m}^3$ , Cyc.....	63
Figure 21:	Results of the parallel measurements, all sites, per.....	64
Figure 22:	Results of the parallel measurements, Cologne, winter, per.....	64
Figure 23:	Results of the parallel measurements, Bonn-Belderberg, per.....	65
Figure 24:	Results of the parallel measurements, bulk handling, summer, per.....	65
Figure 25:	Results of the parallel measurements, bulk handling, winter, per.....	66
Figure 26:	Results of the parallel measurements, all sites, values $\geq 30 \mu\text{g}/\text{m}^3$ , per.....	66
Figure 27:	Reference vs. Tested instrument, S/N 6158, all sites, cyc.....	74
Figure 28:	Reference vs. Tested instrument, S/N 6159, all sites, cyc.....	74
Figure 29:	Reference vs. Tested instrument, S/N 6158, Cologne, winter, cyc.....	75
Figure 30:	Reference vs. Tested instrument, S/N 6159, Cologne, winter, cyc.....	75
Figure 31:	Reference vs. Tested instrument, S/N 6158, Bonn-Belderberg, cyc.....	76
Figure 32:	Reference vs. Tested instrument, S/N 6159, Bonn-Belderberg, cyc.....	76
Figure 33:	Reference vs. Tested instrument, S/N 6158, bulk handling, summer, cyc.....	77
Figure 34:	Reference vs. Tested instrument, S/N 6159, bulk handling, summer, cyc.....	77
Figure 35:	Reference vs. Tested instrument, S/N 6158, bulk handling, winter, cyc.....	78
Figure 36:	Reference vs. Tested instrument, S/N 6159, bulk handling, winter, cyc.....	78
Figure 37:	Reference vs. Tested instrument, S/N 6158, values $\geq 30 \mu\text{g}/\text{m}^3$ , cyc.....	79
Figure 38:	Reference vs. Tested instrument, S/N 6159, values $\geq 30 \mu\text{g}/\text{m}^3$ , cyc.....	79
Figure 39:	Reference vs. Tested instrument, S/N 6158, all sites, per.....	80
Figure 40:	Reference vs. Tested instrument, S/N 6159, all sites, per.....	80
Figure 41:	Reference vs. Tested instrument, S/N 6158, Cologne, winter, per.....	81
Figure 42:	Reference vs. Tested instrument, S/N 6159, Cologne, winter, per.....	81
Figure 43:	Reference vs. Tested instrument, S/N 6158, Bonn-Belderberg, per.....	82
Figure 44:	Reference vs. Tested instrument, S/N 6159, Bonn-Belderberg, per.....	82
Figure 45:	Reference vs. Tested instrument, S/N 6158, bulk handling, summer, per.....	83
Figure 46:	Reference vs. Tested instrument, S/N 6159, bulk handling, summer, per.....	83
Figure 47:	Reference vs. Tested instrument, S/N 6158, bulk handling, winter, per.....	84
Figure 48:	Reference vs. Tested instrument, S/N 6159, bulk handling, winter, per.....	84
Figure 49:	Reference vs. Tested instrument, S/N 6158, values $\geq 30 \mu\text{g}/\text{m}^3$ , per.....	85
Figure 50:	Reference vs. Tested instrument, S/N 6159, values $\geq 30 \mu\text{g}/\text{m}^3$ , per.....	85
Figure 51:	CE certificate.....	122

Figure 52: Certificate of accreditation according to EN ISO/IEC 17025:2005 ..... 123  
Figure 53: Certificate of accreditation according to EN ISO/IEC 17025:2005 - page 2 ... 124

## 1. General

### 1.1 Certification proposal

Based on the positive results obtained, the following recommendation on the announcement of the AMS as a certified system is put forward:

**AMS designation:**

MP101M for suspended particulate matter PM<sub>10</sub>

**Manufacturer:**

ENVEA, Poissy, France

**Field of application:**

For continuous and stationary air quality control of suspended particulate matter, PM<sub>10</sub> fraction

**Measurement ranges during performance testing:**

Component	Certification range	Unit
PM <sub>10</sub>	0 - 10000	µg/m <sup>3</sup>

**Software version:**

MP101M 4.0.h

**Restrictions:**

None

**Notes:**

1. The maintenance interval is one month.
2. This report on the performance test is available online at [www.qal1.de](http://www.qal1.de).

**Test Report:**

TÜV Rheinland Energy GmbH, Cologne  
Report no.: 936/21240384/C dated 15 August 2019

## 1.2 Summary report on test results

### Summary of test results in accordance with standard EN 16450

Performance criterion	Requirement	Test result	satisfied	Page
1 Measuring ranges	0 µg/m <sup>3</sup> to 1000 µg/m <sup>3</sup> as a 24-hour average value 0 µg/m <sup>3</sup> to 10,000 µg/m <sup>3</sup> as a 1-hour average value, if applicable	The upper limit of the measuring range is at 10,000 µg/m <sup>3</sup> .	yes	31
2 negative signals	Shall not be suppressed	The AMS is able to display negative readings directly and via the various measured signal outputs.	yes	32
3 Zero level and detection limit (7.4.3)	Zero level: ≤ 2.0 µg/m <sup>3</sup> Detection limit: ≤ 2.0 µg/m <sup>3</sup>	The zero level and the detection limit were determined at 1.48 µg/m <sup>3</sup> for S/N 6158 and 1.28 µg/m <sup>3</sup> for S/N 6159.	yes	33
4 Flow rate accuracy (7.4.4)	≤ 2.0%	The relative difference determined for the mean of the measuring results at flow rates at 5°C and at 40°C did not exceed -1.63%.	yes	35
5 Constancy of sample flow rate (7.4.5)	≤ 2.0% sampling flow (averaged flow) ≤ 5% rated flow (instantaneous flow)	The 24h-averages deviate from their rated values by less than 0.76%, all instantaneous values deviate by less than 2.7%.	yes	37
6 Leak tightness of the sampling system (7.4.6)	≤ 2.0% of sample flow rate	The criterion for passing the leak test as specified by the AMS manufacturer – maximum flow rate of 5 l/min as well as P1 and P2 below 250 mbar when the inlet is blocked – proved to be adequate during performance testing as a criterion for monitoring the instrument's leak tightness. The maximum leak rate is 4.46 l/min, all pressures determined were below 250 l/min.	yes	40
7 Dependence of measured value on surrounding temperature (7.4.7)	≤ 2.0 µg/m <sup>3</sup>	The tested temperature range was 5 °C to 40 °C. The maximum deviation from the mean reading at TS <sub>n</sub> was at 0.7 µg/m <sup>3</sup> .	yes	42
8 Dependence of measured value (span) on surrounding temperature (7.4.7)	≤ 5% from the value at the nominal test temperature	The tested temperature range was 5 °C to 40 °C. The maximum deviation from the mean reading at 20 °C was at 1.8 µg/m <sup>3</sup> .	yes	44



Performance criterion	Requirement	Test result	satis- fied	Page
9 Dependence of span on supply voltage (7.4.8)	$\leq 5\%$ from the value at the nominal test voltage	Voltage variations did not cause deviations exceeding 0.9% of the average at 230V at the extreme values.	yes	46
10 Effect of failure of mains voltage	Instrument parameters shall be secured against loss. On return of main voltage the instrument shall automatically resume functioning.	All instrument parameters are secured against loss. On return of mains voltage, the instrument returns to normal operating mode and automatically resumes measuring.	yes	48
11 Dependence of reading on water vapour concentration (7.4.9)	$\leq 2.0 \mu\text{g}/\text{m}^3$ in zero air	Differences between readings determined at relative humidities of 40% and 90% did not exceed $1.99 \mu\text{g}/\text{m}^3$ .	yes	49
12 Zero checks (7.5.3)	Absolute value $\leq 3.0 \mu\text{g}/\text{m}^3$	The absolute measured value determined at the zero point did not exceed $0.1 \mu\text{g}/\text{m}^3$ .	yes	51
13 Recording of operational parameters (7.5.4)	Measuring systems shall be able to provide data of operational states for telemetric transmission of – at minimum – the following parameters: Flow rate pressure drop over sample filter (if relevant) Sampling time Sampling volume (if relevant); Mass concentration of relevant PM fraction(s) Ambient temperature Exterior air pressure Air temperature in measuring section temperature of sampling inlet if heated inlet is used	The measuring system allows for comprehensive monitoring and control via various connectors (Ethernet, RS232). The instrument provides operating statuses and all relevant parameters.	yes	53
14 Daily averages (7.5.5)	The AMS shall allow for the formation of daily averages or values.	It is possible to form valid daily averages.	yes	55
15 Availability (7.5.6)	At least 90%.	Availability was at 100% for both instruments.	yes	56
16 Between-AMS uncertainty (7.5.8.4)	$\leq 2.5 \mu\text{g}/\text{m}^3$	At no more than $0.95 \mu\text{g}/\text{m}^3$ the uncertainty between the test specimens remains well below the permissible maximum of $2.5 \mu\text{g}/\text{m}^3$ .	yes	59

Performance criterion	Requirement	Test result	satis- fied	Page
17 Expanded uncertainty (7.5.8.5 – 7.5.8.8)	≤ 25% at the level of the relevant limit value related to the 24-hour average results (after calibration where necessary, see 7.5.8.5)	Without the need for any correction factors, the expanded uncertainties WAMS were below the expanded, relative uncertainty $W_{dqo}$ defined for fine dust at 25% for all data sets observed. As the axis intercept determined for system 1 is significantly different from 0, section 6.1 17 Use of correction factors/terms required the use of a correction factor.	yes	67
17 Use of correction factors/terms (7.5.8.5–7.5.8.8)	After the calibration: ≤ 25% at the level of the relevant limit value related to the 24-hour average results	After the use of correction factors, the candidate systems met the requirements for data quality of air quality monitors for all data sets. The requirements had been met even before a correction factor was applied.	yes	86
18 Maintenance interval (7.5.7)	At least 14 d	The maintenance interval is 1 month.	yes	93
19 Automatic diagnostic check (7.5.4)	Shall be possible for the AMS	The instrument provides all features described in the operation manual. The current operating status is continuously monitored and any issues will be flagged via a series of different warning messages. Data recording includes all monitored parameters.	yes	94
20 Checks of temperature sensors, pressure and/or humidity sensors	Shall be checked for the AMS to be within the following criteria ± 2°C ± 1kPa ± 5 % RH	It is possible to check and adjust the sensors for determining ambient temperature, ambient pressure and relative humidity on-site. The sensors' deviations remained within the required ranges.	yes	95

## 2. Task Definition

### 2.1 Nature of the test

ENVEA commissioned TÜV Rheinland Energy GmbH to submit the MP101M air quality monitor for suspended particulate matter PM<sub>10</sub> to performance testing.

### 2.2 Objectives

The air quality monitor is designed to determine suspended particulate matter PM<sub>10</sub> in ambient air in the concentration range between 0 and 10,000 µg/m<sup>3</sup>.

The measuring system uses beta attenuation to determine the concentration of suspended particulate matter.

The test was performed on the basis of the following standards:

- Standard EN 16450 “Ambient air – Automated measuring systems for the measurement of the concentration of particulate matter (PM<sub>10</sub>; PM<sub>2.5</sub>, German version dated July 2017)
- VDI Standard 4202, part 3, “Automated measuring systems for air quality monitoring Performance test, declaration of suitability and certification of measuring systems for point-related measurement of mass concentration for particulate air pollutants”, February 2019
- European standard EN 12341, “Ambient air - Standard gravimetric measurement method for the determination of the PM<sub>10</sub> or PM<sub>2,5</sub> mass concentration of suspended particulate matter”; German version EN 12341:2014
- Guideline “Demonstration of Equivalence of Ambient Air Monitoring Methods”, English version dated January 2010

### 3. Description of the AMS tested

#### 3.1 Measuring principle

The MP101M measuring system is designed to measure suspended particulate matter in ambient air. The determination of the mass concentration relies on the principle of beta ray attenuation. The sample is first sucked through a PM<sub>10</sub> pre-separator and then through a glass fibre filter tape in the instrument. Suspended particulate matter is deposited on the filter tape. Every hour, a beta source (<sup>14</sup>C element) is swivelled in to determine the mass deposited on the filter tape. A Geiger Müller counter measuring beta radiation is situated below the filter tape. The <sup>14</sup>C radioelement emits beta rays as it decays. Particles deposited on the filter tape partially absorb the beta radiation. The filter spot is measured before and after loading. The difference in radiation intensity measured by the Geiger Müller counter serves as measure for the deposited amount of particulate matter.

#### 3.2 Functioning of the measuring system

The particulate sample passes the sampling head (USEPA) at a flow rate of 16.67 l/min and enters the sampling tube, which connects the sampling head to the actual measuring instrument. The sampling head separates all particles larger than PM<sub>10</sub>. The sampling tube can be heated in order to avoid possible condensation effects, especially in situations with high outdoor air humidity. After entering the measuring instrument, the air stream contained in the sample is separated on the filter tape. After leaving the measuring system, the air flow reaches the pump and then exits into the environment via a particle filter.



Figure 1:View of the MP101M

Every hour (1 period), the sample volumetric flow is stopped and a beta radiation source is swivelled over the filter band. The Geiger Müller counter situated below the filter tape measures the intensity of radiation. Every filter tape is measured before and after filter loading. The absorbed radiation is proportional to the separated particle mass and thus the absorption difference is the measured quantity. One measurement takes 200 seconds. The

measured values of 24 periods are the averaged 24 hour value (1 cycle). After 24 hours, the filter tape is transported forward and a new blank spot is sampled.

The volumetric flow is kept constant at 1m<sup>3</sup>/h in the separator head. Since the velocity in the sampling head determines the separation characteristics, the volume flow is controlled by the weather sensors so that the volume flow in the sampling head is constant.

The sampling tube can be heated to avoid condensation effects. Since excessive temperatures in the sampling tube can lead to reduced results due to volatilization, the sampling tube is only heated as much as absolutely necessary. A sensor measuring relative moisture is situated near the Geiger Müller counter. If this sensor detects relative moisture above 50%, the heater will be activated.



(1) reference gauge, (3) source holder, (4) retractable tip on sample inlet, (5) capstan, (6) pinch roller, (7) take-up reel, (8) Geiger-Müller detector tube, (9) plate assembly, (10) pay-out reel.

Figure 2: Front view of the MP101M (open)

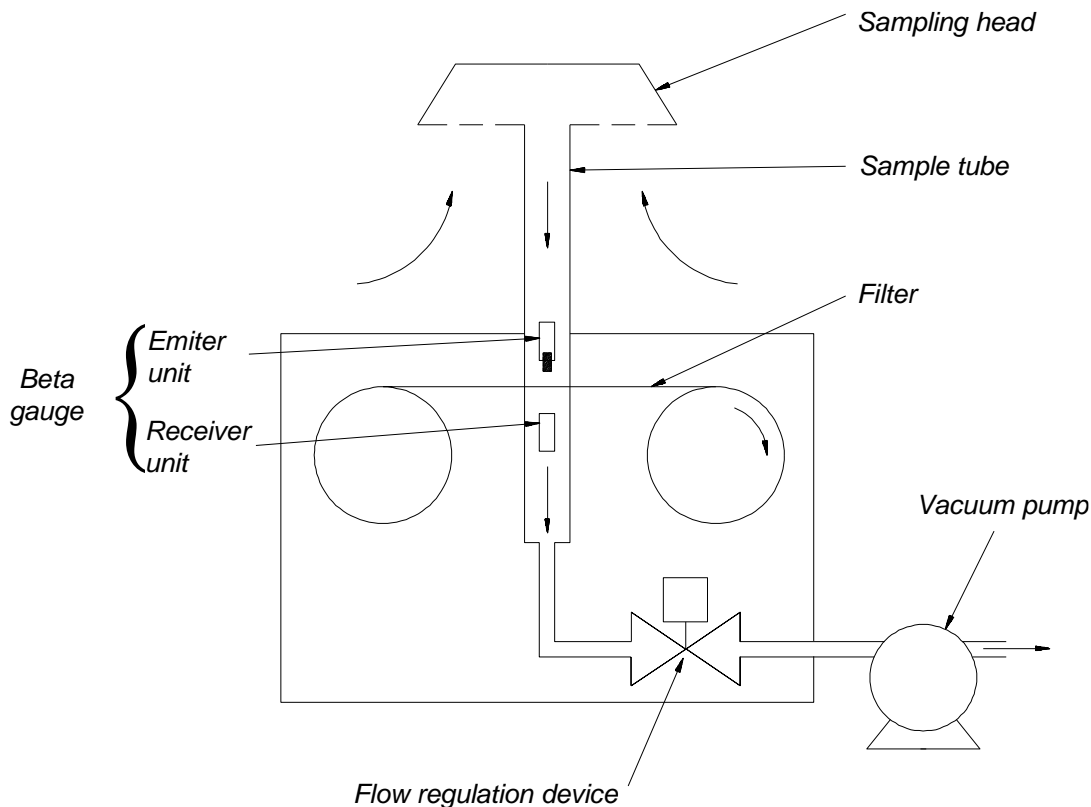


Figure 3: Functional diagramme MP101M

The MP101M measuring system saves data in a text format. Results are already converted to particle mass concentrations.

The measuring system generally provides results simultaneously via the display and the data records. Measured values are updated hourly after each measurement (periodically, "Per.") and every 24 hours (cyclically, "Cyc."). Where feasible, all tests were evaluated separately for the two options of data output. Results are indicated for both output options. Tests referring to the flow rate or using the reference foil were not evaluated separately.

### 3.3 AMS scope and set-up

The measuring system is designed to be installed at temperature controlled sites (e.g. air conditioned measuring station).

The tested AMS consists of

- the PM<sub>10</sub> USEPA sampling head,
- the sampling tube with heater, protective tube made of stainless steel and isolation (2m long),
- the weather sensor (mounted at the sampling tube below the sample inlet) comprising a temperature sensor and a sensor which determines the relative moisture.
- the analyser,
- the pump unit,
- the required connecting tubes and cables,
- the operation manuals in German.

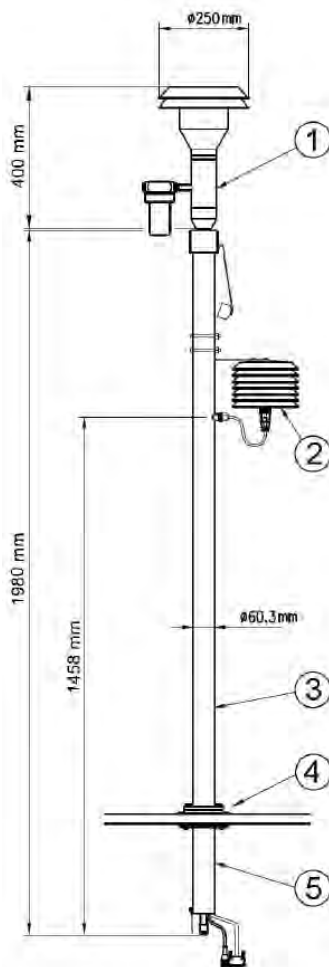


Figure 4: Sampling (1) PM<sub>10</sub> sampling head (2) weather sensor, (3) sample line, (4) roof bushing, (5) sample line inside





Figure 5: MP101M measuring systems on the measuring station (bulk handling)

The measuring system may be operated either directly via the touch screen at the front of the instrument or remotely via an internet connection or a wireless modem. The user may retrieve measurement data and system information, change parameters and perform functionality tests of the measuring system.

A zero filter is mounted to the instrument inlet for the purpose of external zero checks. The use of this filter allows the provision of PM-free air. A special foil is used for span checks which is manually placed between the beta ray source and the Geiger Müller counter.



## 4. Test programme

### 4.1. General

The performance test was carried out using two identical instruments with the following serial numbers:

System 1 6158

System 2 6159

Software version MP101M 4.0.h was implemented during the performance test.

During the test, both instruments were also equipped with what is referred to as a CPM+ module. This CPM+ module is an additional optical scattered light sensor for the determination of PM<sub>2.5</sub>. The CPM+ module is mounted directly to the central unit of the sampling tube. The sample stream is passed straight through the CPM+ module to the MP101M analyser without deflection from the sampling tube. The CPM+ module is not included in the scope of the certification. To demonstrate the CPM+ module does not affect the measuring results determined for PM<sub>10</sub>, it was removed from one of the instruments after 4 field test campaigns. An additional field test was then performed and the between-AMS uncertainty compared between the instruments with and without the CPM+ module ( $U_{bs,AMS}$ ). Section 6.1 16 Between-AMS uncertainty (7.5.8.4) presents the results of these tests.

The measuring system generally provides results simultaneously via the display and the data records. Measured values are updated hourly after each measurement (periodically, "Per.") and every 24 hours (cyclically, "Cyc."). Where feasible, all tests were evaluated separately for the two options of data output. Results are indicated for both output options. Tests referring to the flow rate or using the reference foil were not evaluated separately.

### 4.2 Laboratory test

The laboratory test was carried out with two identical instruments, type MP101M, with serial numbers S/N: 6158 and SN: 6159. Standard [9] specifies the following test programme for the laboratory test:

- Readings
- Negative signals
- Zero level and detection limit
- Flow rate accuracy
- Water tightness of the sampling system
- Dependence of the zero point on the ambient temperature
- Dependence of the reading on the ambient temperature
- Effect of mains voltage on the reading
- Effect of failure of mains voltage
- Effect of humidity on the reading

The following devices were used to determine the performance characteristics during the laboratory tests.

- Climatic chamber (temperature range  $-20^{\circ}\text{C}$  to  $+50^{\circ}\text{C}$ , accuracy better than  $1^{\circ}\text{C}$ ).
- Isolating transformer,
- 1 mass flow meter Model 4043 (manufacturer: TSI)
- 1 reference flow meter, type BIOS Met Lab 500 (manufacturer: Mesa Lab)
- Zero filter for external zero checks
- Reference foils

The measured values were recorded internally. The set of raw data was downloaded and evaluated in Excel.

Chapter 6 summarizes the results of the laboratory tests.

### 4.3 Field test

The field test was carried out with two identical instruments, type MP101M, with serial numbers S/N: 6158 and SN: 6159. Standard [4] specifies the following test programme for the field test:

- Constancy of sample volumetric flow
- Zero checks
- Recording of operational parameters
- Daily values/daily averages
- Availability
- Between-AMS uncertainty
- Expanded uncertainty
- Maintenance interval/period of unattended operation
- Automatic diagnostic check
- Checks of temperature sensors, pressure and/or humidity sensors

The following instruments were used during the field test.

- Measurement container provided by TÜV Rheinland, air-conditioned to about  $20^{\circ}\text{C}$
- Weather station (WS 888 manufactured by ELV Elektronik AG) for collecting meteorological data such as temperature, air pressure, humidity, wind speed, wind direction and precipitation.
- 2 reference measuring systems, LVS3 for  $\text{PM}_{10}$  in accordance with item 5
- 1 mass flow meter Model 4043 (manufacturer: TSI)
- Zero filter for external zero checks
- Calibration foil

During the field test, two MP101M measuring systems and two reference systems each for PM<sub>10</sub> were operated simultaneously over a period of 24h. The reference system is a discontinuous system: the filter has to be replaced manually after sampling.

Impaction plates of the PM<sub>10</sub> sampling inlets were cleaned approximately every two weeks during the test period and greased with silicone grease in order to ensure reliable separation of particles. The sampling inlets of the candidate systems were cleaned roughly every three months in line with the manufacturer's instructions. The sampling head generally has to be cleaned following the manufacturer's instruction taking into account local concentrations of suspended particulate matter.

The flow rates of the tested and the reference instruments were checked before and after each re-location using a dry gas meter or a mass flow controller in each case connected to the instrument's air inlet via a hose line.

### Sites of measurement and instrument installation

Measuring systems in the field test were installed in such a way that only the sampling inlets were outside the measuring container on its roof. The central units of the tested instruments were positioned inside the air-conditioned measurement cabinet. The reference system (LVS3) was installed outdoors on the roof of the measurement container.

The field test was performed at the following measurement sites:

Table 3: Field test sites

No.	Measurement site	Period	Description
1	Cologne, Winter	12/2017 – 03/2018	Urban background
2	Bonn-Belderberg	04/2018 – 06/2018	Urban background Affected by traffic
3	Cologne Bulk handling, Summer	07/2018 – 11/2018	Industrial background
4	Cologne Bulk handling, Winter	12/2018 – 02/2019	Industrial background

Figure 6 to Figure 9 show the PM concentrations measured with the reference systems at the field test sites.

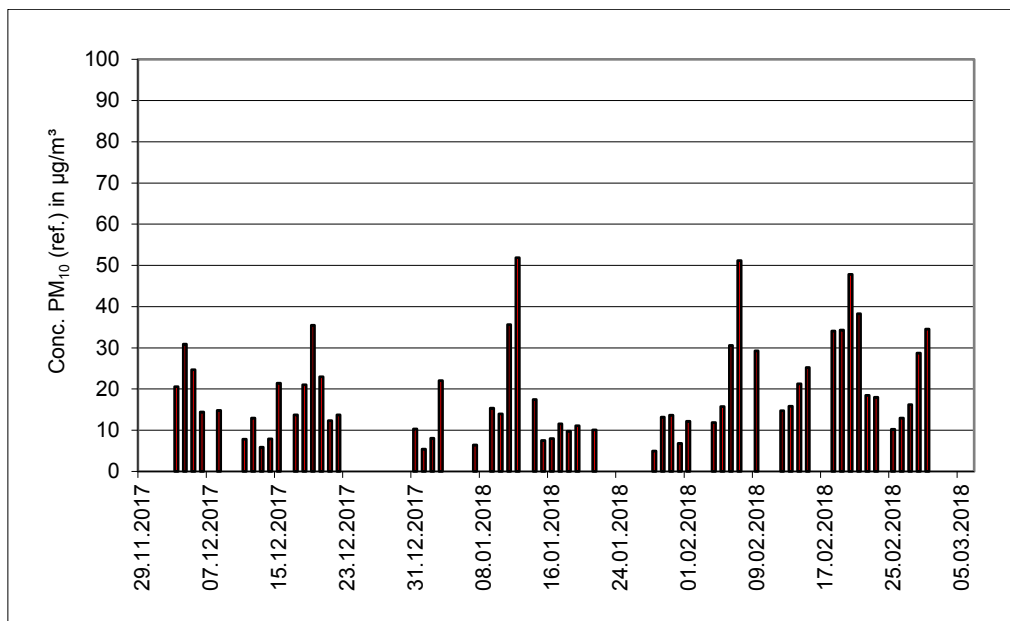


Figure 6: PM<sub>10</sub> concentrations (reference) in "Cologne, winter"

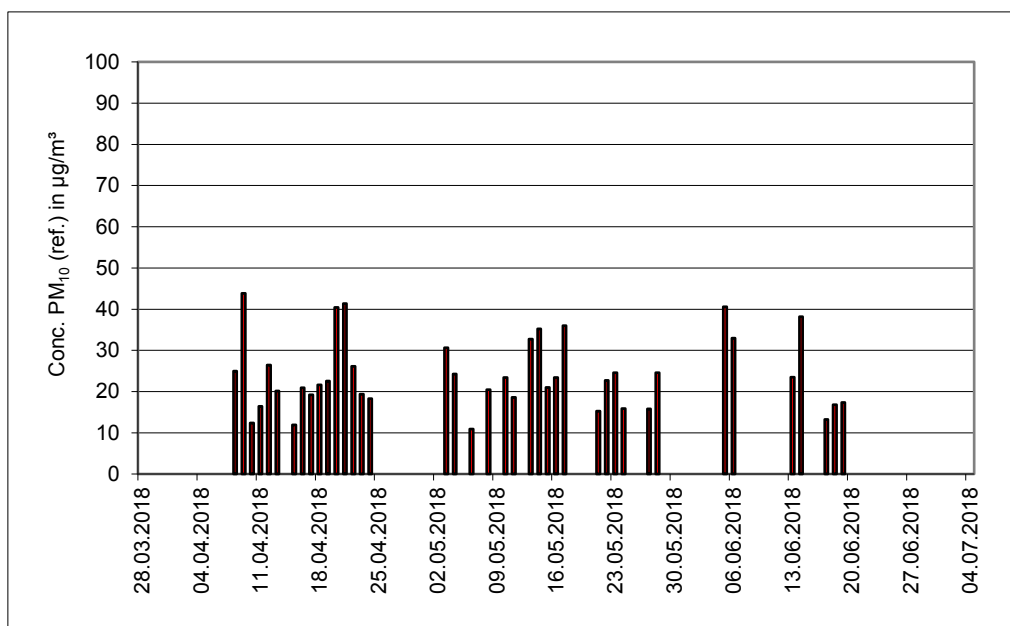


Figure 7: PM<sub>10</sub> concentrations (reference) in "Bonn-Belderberg"

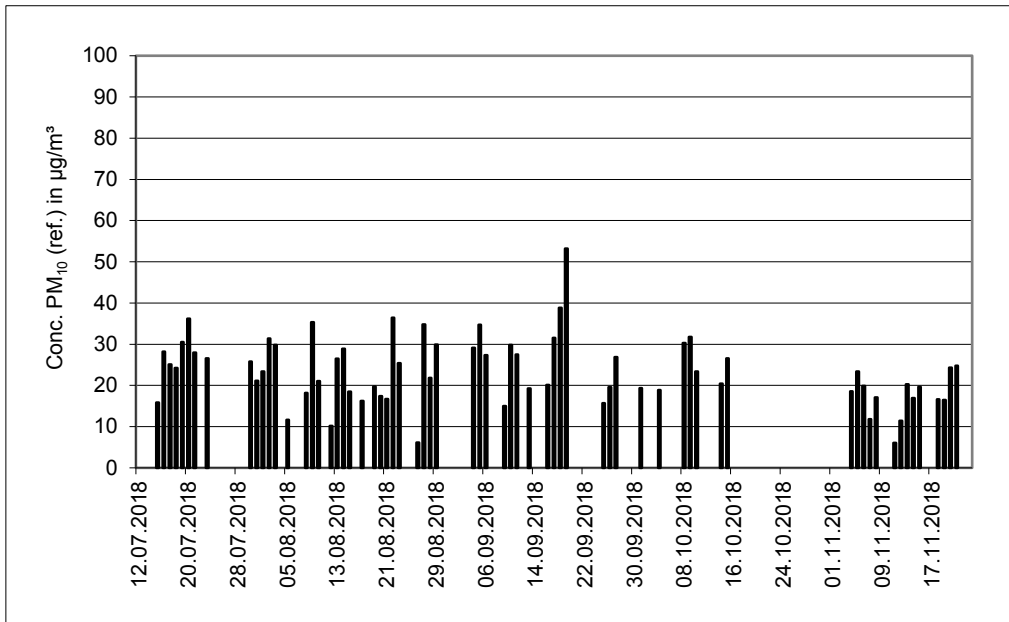
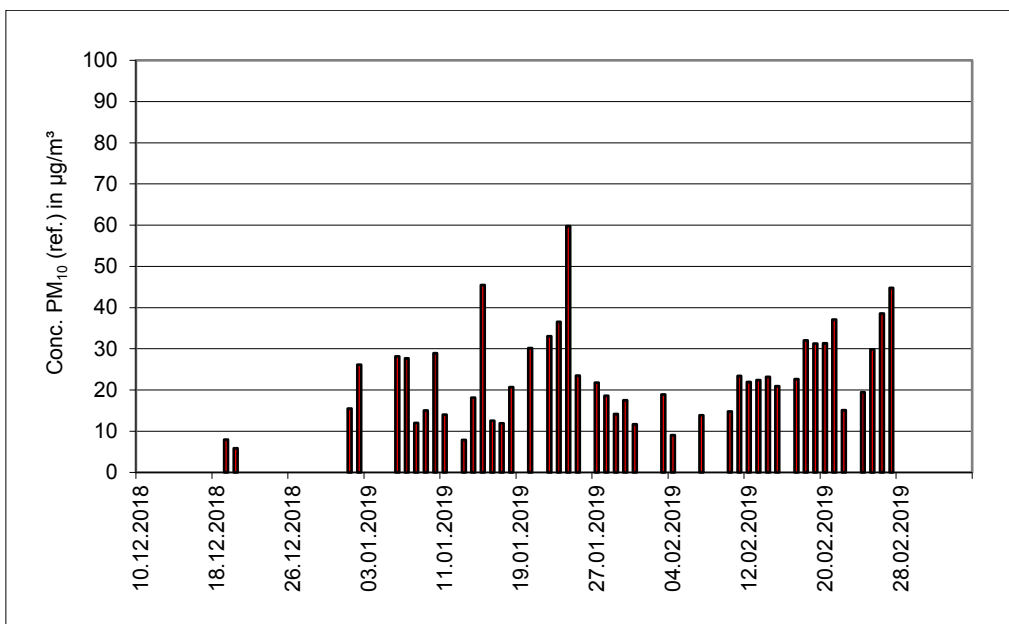


Figure 8: PM<sub>10</sub> concentrations (reference) in "Bulk handling, summer"



The photos below show the measurement container at the field test sites in Cologne (parking lot and bulk handling) and in Bonn.



Figure 10: Field test site Cologne, winter



Figure 11: Field test site in Bonn-Belderberg





Figure 12: Field test site in Cologne, bulk handling, summer + winter

In addition to the air quality measuring systems for monitoring suspended particulate matter, a data logger for meteorological data was installed at the container/measurement site. Data on air temperature, pressure, humidity, wind speed, wind direction and precipitation were continually measured. 10-minute mean values were recorded.

The following dimensions describe the design of the measurement cabinet as well as the position of the sampling probes.

Germany

- Height of cabinet roof. 2.50m
- Height of the sampling system for test/ Reference system 3.70m/1.20m above cabinet roof 3.47m above ground/0.97 m above container roof
- Height of the wind vane: 4.5 m above ground level

In addition to an overview of the meteorological conditions determined during measurements at the 4 field test sites, the following Table 4 therefore provides information on the concentrations of suspended particulate matter.

Table 4: Ambient condition at the field test sites (Germany)  
 as daily averages

	Cologne Winter	Bonn-Belderberg	Bulk handling, Summer	Bulk handling, Winter
number of measurements PM <sub>10</sub> reference	57	40	66	45
<b>Ratio of PM<sub>2.5</sub> to PM<sub>10</sub> [%]</b>				
Range	40.8 - 92.3	34.8 / 72.3	30.9 - 80.8	35.4 / 98.5
Average	70.1	53.1	51.4	61.0
<b>Air temperature [°C]</b>				
Range	-5.2 - 12.0	6.8 / 29.4	2.4 / 28.5	-2.8 - 12.8
Average	4.7	18.7	15.5	5.7
<b>Air pressure [hPa]</b>				
Range	973 – 1026	991 – 1019	981 – 1026	981 – 1029
Average	1005	1006	1006	1010
<b>Rel. Humidity [%]</b>				
Range	43.2 / 92.7	35.7 / 87.8	37.1 / 94.8	46.1 / 87.7
Average	76.6	61.9	70.5	74.5
<b>Wind speed [m/s]</b>				
Range	0.1 / 5.3	0.9 / 3.7	0.5 / 15.3	0.0 / 29.2
Average	1.5	1.8	5.3	8.0
<b>Precipitation rate [mm/d]</b>				
Range	0.0 / 19.4	0.0 / 31.6	0.0 / 19.6	0.0 / 22.3
Average	1.5	3.1	1.1	2.7



### Sampling duration

Standard EN 12341 [3] fixes the sampling time at 24 h ± 1 h.

During the entire field test, all instruments were set to a sampling time of 24 h (from 10:00 to 10:00 o'clock).

### Data handling

Prior to their assessment for each field test site, measured value pairs determined from reference values during the field test were submitted to a statistical Grubb's test for outliers (99%) in order to prevent distortions of the measured results from data, which evidently is implausible. Measured values pairs detected as significant outliers may be expunged from the pool of values as long as the test statistic remains above the critical value. In accordance with standard EN 16450 [4], it is permitted to remove up to 2.5% of data pairs that qualify as outliers of reference results as long as the number of valid data pairs per comparison its at least 40. No outliers have been identified for PM<sub>10</sub>.

In principle, no measured value pairs are expunged for the tested AMS, unless there are justifiable technical reasons for implausible values. During the entire test, no implausible measured values were expunged for the tested AMS.

### Filter handling – Mass measurement

The following filters were used during performance testing:

Table 5: Filter materials used

Measuring device	Filter material, type	Manufacturer
Reference devices LVS3	Emfab™, Ø 47 mm	Pall

Filter handling was performed in compliance with EN 12341.

The methods used for processing and weighing filters and for weighing are described in detail in appendix 2 to this report.

## 5. Reference Measurement Method

The following instruments were used for the field test.

1. as PM<sub>10</sub> reference system: Low Volume Sampler LVS3  
Manufacturer: Sven Leckel Ingenieurbüro GmbH, Berlin  
Date of manufacture: 2000 + 2010  
PM<sub>10</sub> sampling head

During the tests, two reference systems for PM<sub>10</sub> were operated in parallel with the flow controlled at 2.3 m<sup>3</sup>/h. Under normal conditions the accuracy of flow control is < 1% of the nominal flow rate.

For the LVS3 low volume sampler, the rotary vane vacuum pump takes in sample air via the sampling inlet. The volumetric flow is measured between the filter and the vacuum pump with the help of a measuring orifice. The air taken in flows from the pump via a separator for the abrasion of the rotary vane to the air outlet.

After sampling has been completed, the electronics display the sample air volume in standard or operating m<sup>3</sup>.

The PM<sub>10</sub> concentrations were determined by dividing the quantity of suspended particulate matter on each filter determined in the laboratory with a gravimetric method by the corresponding throughput of sample air flow as operating m<sup>3</sup>.

As the performance test of the ENVEA MP101M measuring system for was carried out for PM<sub>2,5</sub> in parallel, reference systems for PM<sub>2,5</sub> were operated simultaneously. It was thus possible to calculate the PM<sub>2,5</sub>/PM<sub>10</sub> ratio. Appendix 1, part 6 shows the results of the PM<sub>2,5</sub> determination.

## 6. Test results

### 6.1 1 Measuring ranges

*The measuring ranges should meet the following requirements:  
0 µg/m<sup>3</sup> to 1000 µg/m<sup>3</sup> as a 24-hour average value  
0 µg/m<sup>3</sup> to 10,000 µg/m<sup>3</sup> as a 1-hour average value, if applicable*

### 6.2 Equipment

The test of this criterion did not require any further equipment.

### 6.3 Testing

It was tested whether the measuring system's upper limit of measurement meets the requirements .

### 6.4 Evaluation

The instrument allows to set the measuring range to a maximum of 0–10,000 µg/m<sup>3</sup>.

### 6.5 Assessment

The upper limit of the measuring range is at 10,000 µg/m<sup>3</sup>.  
Criterion satisfied? yes

### 6.6 Detailed presentation of test results

Not required for this performance criterion

## **6.1 2 negative signals**

*Negative signals shall not be suppressed.*

## **6.2 Equipment**

The test of this criterion did not require any further equipment.

## **6.3 Testing**

The possibility of displaying negative signals was tested both in the laboratory and in the field test.

## **6.4 Evaluation**

The measuring system is able to output negative signals both via its display and its data outputs.

## **6.5 Assessment**

The AMS is able to display negative readings directly and via the various measured signal outputs.

Criterion satisfied? yes

## **6.6 Detailed presentation of test results**

Not required for this performance criterion

### 6.1 3 Zero level and detection limit (7.4.3)

Zero level:  $\leq 2.0 \mu\text{g}/\text{m}^3$

Detection limit:  $\leq 2.0 \mu\text{g}/\text{m}^3$

### 6.2 Equipment

Zero filter for zero checks

### 6.3 Testing

*The zero level and detection limit of the AMS shall be determined by measurement of 15 24-hour average readings obtained by sampling from zero air (no rolling or overlapped averages are permitted). The mean of these 15 24-h averages is used as the zero level. The detection limit is calculated as 3.3 times the standard deviation of the 15 24h-averages.*

The zero level and the detection limit were determined with zero filters installed at the AMS inlets of the instruments during normal operation. Air free of suspended particulate matter is applied over a period of 15 days for a duration of 24h each.

### 6.4 Evaluation

The detection limit  $X$  is calculated from the standard deviation  $s_{x_0}$  of the measured values sucking air free from suspended particulate matter through both test specimen. It is equal to the standard deviation of the average  $\bar{x}_0$  of the measured values  $x_{0i}$  multiplied by 3.3 for each test specimen.

$$X = 3.3 \cdot s_{x_0} \quad \text{where } s_{x_0} = \sqrt{\frac{1}{n-1} \cdot \sum_{i=1,n} (x_{0i} - \bar{x}_0)^2}$$

### 6.5 Assessment

The zero level and the detection limit were determined at  $1.48 \mu\text{g}/\text{m}^3$  for S/N 6158 and  $1.28 \mu\text{g}/\text{m}^3$  for S/N 6159.

Criterion satisfied? yes

## 6.6 Detailed presentation of test results

Table 6: Zero level and detection limit PM<sub>10</sub>, Cyc.

		Device SN 6158	Device SN 6159
Number of values n		15	15
Average of the zero values (Zero level) $\bar{x}_0$	µg/m <sup>3</sup>	0.35	0.33
Standard deviation of the values $s_{x0}$	µg/m <sup>3</sup>	0.45	0.38
Detection limit x	µg/m <sup>3</sup>	<b>1.48</b>	<b>1.26</b>

Table 7: Zero level and detection limit PM<sub>10</sub>, Per.

		Device SN 6158	Device SN 6159
Number of values n		15	15
Average of the zero values (Zero level) $\bar{x}_0$	µg/m <sup>3</sup>	0.35	0.33
Standard deviation of the values $s_{x0}$	µg/m <sup>3</sup>	0.45	0.39
Detection limit x	µg/m <sup>3</sup>	<b>1.48</b>	<b>1.28</b>

Schedule 1 in the annex contains the individual measured values for the determination of the zero level and detection limit.

#### **6.1 4 Flow rate accuracy (7.4.4)**

*The relative difference between the two values determined for the flow rate shall be  $\leq 2.0\%$ .*

*The relative difference between the two values determined for the flow rate shall fulfil the following performance requirements:*

$\leq 2.0\%$

- *at 5°C and 40°C for installations in an air-conditioned environment by default*
- *at minimum and maximum temperatures specified by the manufacturer if these deviate from the default temperatures.*

#### **6.2 Equipment**

Climatic chamber for the temperature range between 5 and 40 °C, a reference flow meter in accordance with item 4,,

#### **6.3 Testing**

At each temperature, at least ten independent measurements shall be performed over a minimum period of one hour at the operating flow rate specified by the manufacturer. The measurements shall be performed at equal intervals over the measurement period. For each temperature, the mean of the measurement results shall be compared with the operational flow rate.

The MP101M measuring system operates at a flow rate of 1 m<sup>3</sup>/h (16.67 l/min).

With the help of a reference flow meter, the volume flow was measured at 5 °C and 40 °C by means of 10 measurements over 1 hour at the operational volume flow specified by the manufacturer. The measurements were performed at equal intervals throughout the measurement period.

#### **6.4 Evaluation**

Averages were calculated from the 10 measured values determined at each temperature and deviations from the operating flow rate determined.

#### **6.5 Assessment**

The relative difference determined for the mean of the measuring results at flow rates at 5°C and at 40°C did not exceed -1.63%.

Criterion satisfied? yes

## 6.6 Detailed presentation of test results

The results of the flow measurements at the permissible ambient temperature are presented below:

Table 8: Flow rate accuracy at +5 °C and +40 °C

		Device SN 6158	Device SN 6159
Nominal value flow rate	l/min	16.67	16.67
Mean value at 5°C	l/min	16.40	16.48
Dev. from nominal value	%	-1.63	-1.15
Mean value at 40°C	l/min	16.88	16.88
Dev. from nominal value	%	1.25	1.27

Schedule 2 in the annex contains the individual measured values for the determination of the flow rate accuracy.



## 6.1 5 Constancy of sample flow rate (7.4.5)

*The instantaneous flow rate and the flow rate averaged over the sampling period shall fulfil the performance requirements below.*

*≤ 2.0% sample flow (instantaneous flow)*

*≤ 5% rated flow (instantaneous flow)*

## 6.2 Equipment

For this test, an additional reference flow meter in accordance with item 4 was provided.

## 6.3 Testing

The MP101M measuring system operates at a flow rate of 1 m<sup>3</sup>/h (16.67 l/min).

The sample flow rate was calibrated before and after each first field test and then checked with the help of a mass flow controller at every new field test site and re-adjusted when necessary.

To determine the constancy of the sample flow rate, the flow rate was recorded and evaluated with the help of a mass flow meter once over a period of 24h.

## 6.4 Evaluation

The average, standard deviation as well as the maximum and minimum values were determined from the measured values for the flow rate (24-hour average).

## 6.5 Assessment

No deviations exceeding 2.8% were found in the flow rate controls in the field (short-term value).

The charts illustrating the constancy of the sample flow rate (24h average) demonstrate that all measured values determined during sampling deviate from their respective rated values by less than 2.7%. The deviation of the daily averages for the overall flow rate of 16.67 l/min did not exceed -0.76% of the rated value.

The 24h-averages deviate from their rated values by less than 0.76%, all instantaneous values deviate by less than 2.7%.

Criterion satisfied? yes

## 6.6 Detailed presentation of test results for the rated flow

Table 9 presents the results of the flow rate checks performed at every field test site.

Table 9: Results of flow rate checks at the end of the field test (instantaneous values)

Flow rate check before:	SN 6158		SN 6159	
Field test site:	[l/min]	Dev. from target [%]	[l/min]	Dev. from target [%]
Cologne, Winter	16.70	0.2	16.60	-0.4
Bonn-Belderberg	16.65	-0.1	16.95	1.7
Bulk handling, summer	16.88	1.3	16.58	-0.5
Bulk handling, winter	16.75	0.5	16.20	-2.8

Table Table 10 lists the characteristics determined for the flow rate. Figure 13 to Figure 14 provide a chart of the flow rate measurement for both instruments.

Table 10: Performance characteristics for the overall flow rate measurement (daily average)

		Device SN 6158	Device SN 6159
Mean value	l/min	16.54	16.67
Dev. from nominal value	%	-0.76	-0.01
Standard deviation	l/min	0.13	0.11
Minimum value	l/min	16.22	16.40
Maximum value	l/min	16.92	17.06

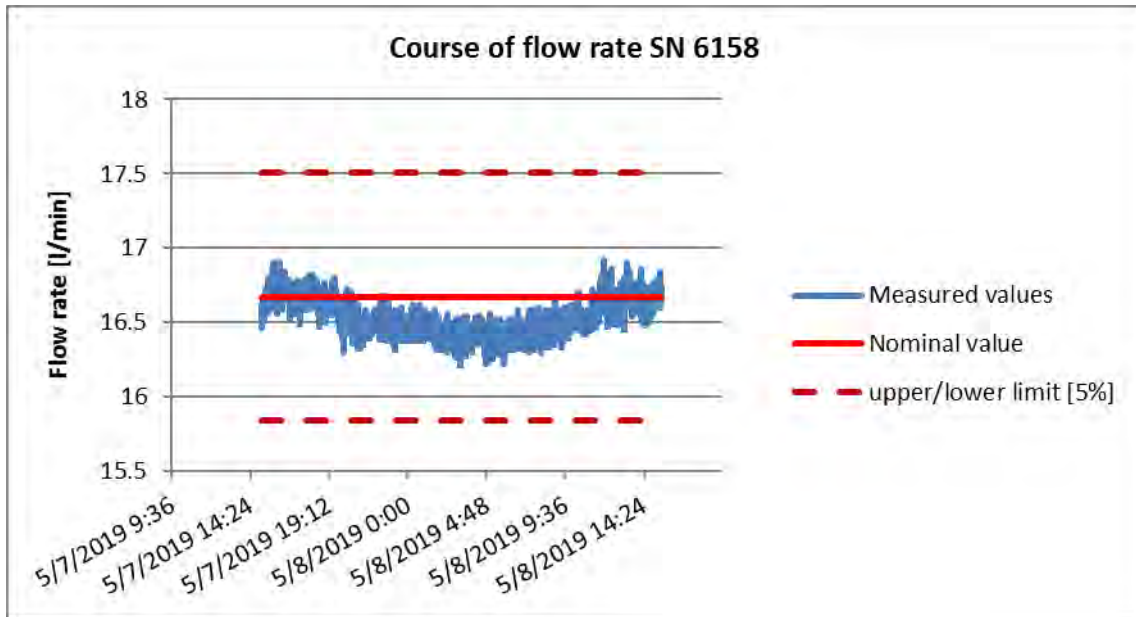


Figure 13: Flow rate of tested instrument SN 6158

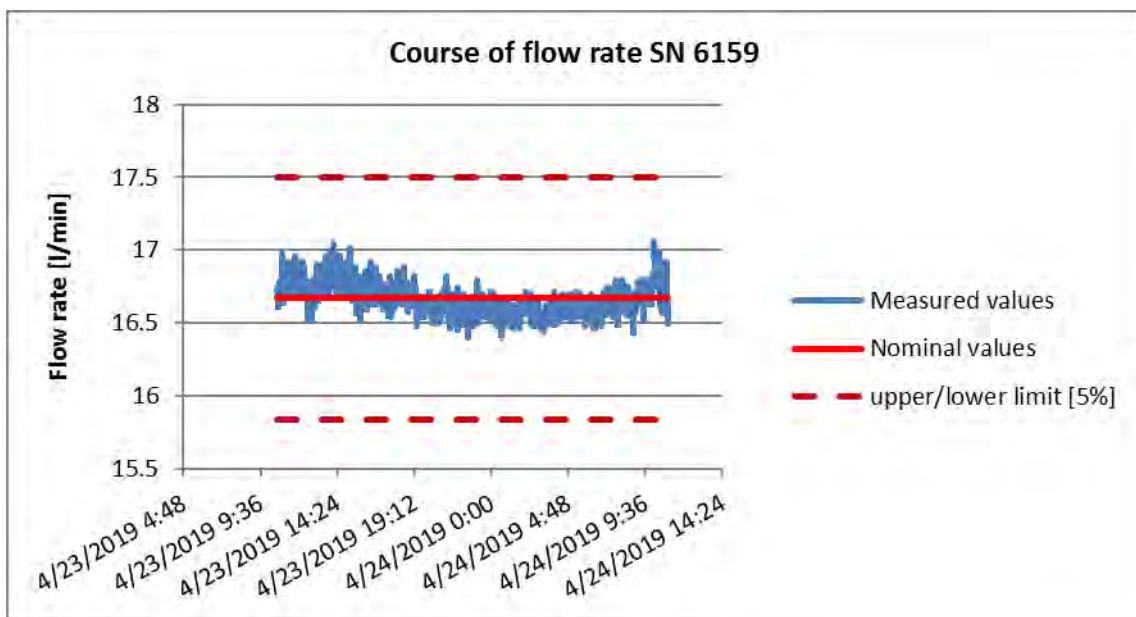


Figure 14: Flow rate of tested instrument SN 6159

## **6.1 6 Leak tightness of the sampling system (7.4.6)**

*Leakage shall not exceed 2.0% of the sample flow rate or else meet the AMS manufacturer's specifications in complying with the required data quality objectives (DQO).*

## **6.2 Equipment**

Means to block the sample inlet

## **6.3 Testing**

The leak tightness (leak rate) of the complete air flow path of the AMS (sample inlet, sampling line, measuring system) shall be tested according to the manufacturer's specification. A leak test integrated in an AMS can be used, provided that the stringency of such a test is suitable for a proper assessment of the instrument's leak tightness.

If the complete system cannot be tested for technical reasons, the leak rate can be determined separately for each element of the flow path. Since it was not possible to properly block the sample inlet, the inlet was not included in the test.

There is a defined procedure to verify the leak tightness of the MP101M measuring system. For this purpose, the leak tightness test mode was activated in accordance with chapter 3.4.2.12 of the operation manual and the instrument blocked. To this effect, the sample inlet is removed and a ball valve recommended by the manufacturer is fitted. In accordance with the manufacturer's specifications, the flow rate measured by the instrument with the pump running and the ball valve closed should drop to 5 l/min and the pressures P1 and P2 of the internal differential pressure measurement should be below 250 mbar. As soon as the pressures dropped below 250 mbar, the pump is automatically switched off to avoid damage to the instrument.

This procedure was carried out at the beginning and at the end of the field test at every location.

## **6.4 Evaluation**

The leak test was carried out at the beginning and at the end of the field test at every location.

The criterion for passing the leak test as specified by the AMS manufacturer – maximum flow rate of 5 l/min as well as P1 and P2 below 250 mbar when the inlet is blocked – proved to be adequate during performance testing as a criterion for monitoring the instrument's leak tightness. Compared to the standard sample volumetric flow, a maximum flow of 5 l/min appears rather high. This is explained by the very small pressure difference of less than 1 mbar at this volume flow and absolute pressure. If the system pressure is below 250 mbar when the pump is running and the ball valve closed, it can safely be assumed that the measuring system is leak-tight.

The maximum leak rate is 4.46 l/min, all pressures determined were below 250 l/min.

## 6.5 Assessment

The criterion for passing the leak test as specified by the AMS manufacturer – maximum flow rate of 5 l/min as well as P1 and P2 below 250 mbar when the inlet is blocked – proved to be adequate during performance testing as a criterion for monitoring the instrument’s leak tightness. The maximum leak rate is 4.46 l/min, all pressures determined were below 250 l/min.

Criterion satisfied? yes

## 6.6 Detailed presentation of test results

Table 11 lists the result from the leak test.

Table 11: Results of the leak tests obtained during the field tests at the beginning of each campaign

Location	SN 6158	SN 6159	max. permissible leak rate in l/min
	Leak rate in l/min	Leak rate in l/min	
Cologne, Winter	3.08	3.68	5
Bonn-Belderberg	3.68	0.81	5
Bulk handling, summer	3.79	0.95	5
Bulk handling, winter	4.46	0.88	5

## 6.1 7 Dependence of measured value on surrounding temperature (7.4.7)

*The differences found shall comply with the performance criteria given below.*

*Zero point  $\leq 2.0 \mu\text{g}/\text{m}^3$*

- *between 5°C and 40°C by default, for installations in an air-conditioned environment.*
- *at minimum and maximum temperatures specified by the manufacturer if these deviate from the default temperatures.*

## 6.2 Equipment

Climatic chamber for the temperature range between 5 and +40 °C; zero filter for the zero point check

## 6.3 Testing

The dependence of the zero reading and span value, measured by applying a calibration artefact on the surrounding temperature, shall be determined at the following temperatures:

- a) at a nominal temperature  $T_{S,n} = +20 \text{ °C}$ ;
- b) at a minimum temperature  $T_{S,1} = 5 \text{ °C}$
- c) at a maximum temperature  $T_{S,2} = 40 \text{ °C}$ .

To test the dependence of the zero point on the surrounding temperature, the complete measuring system was operated in a climatic chamber. Sample air, free of suspended particles, was supplied to the two candidate systems after fitting two zero filters at the AMS inlet in order to perform zero point checks.

At each temperature setting, three separate measurement results shall be recorded at the zero point.

The criteria for the running-in or stabilisation time listed in Section 7.4.2.1 have to be met at each temperature setting.

The tests were performed in the temperature sequence  $T_{S,n} - T_{S,1} - T_{S,n} - T_{S,2} - T_{S,n}$ .

Readings were recorded at zero point after an equilibration period of at least 6h for every temperature step (3 readings each).

## 6.4 Evaluation

Measured values for the concentrations of the individual readings were read and evaluated.

In order to exclude any possible drift due to factors other than temperature, the measurements at  $T_{S,n}$  were averaged.

The differences between readings at both extreme temperatures and  $T_{S,lab}$  were determined.

## 6.5 Assessment

The tested temperature range was 5 °C to 40 °C. The maximum deviation from the mean reading at  $T_{S,n}$  was at 0.7  $\mu\text{g}/\text{m}^3$ .

Criterion satisfied? yes

## 6.6 Detailed presentation of test results

Table 12: Dependence of the zero point on the surrounding temperature, deviation in  $\mu\text{g}/\text{m}^3$ , average of measurements, cyc.

Temperature °C	SN 6158		SN 6159	
	Measured value	Deviation to mean value at 20°C	Measured value	Deviation to mean value at 20°C
	$\mu\text{g}/\text{m}^3$	$\mu\text{g}/\text{m}^3$	$\mu\text{g}/\text{m}^3$	$\mu\text{g}/\text{m}^3$
20	-0.6	-0.3	0.3	0.0
5	0.3	0.7	0.1	-0.2
20	0.3	0.6	0.0	-0.2
40	-0.9	-0.6	0.8	0.5
20	-0.7	-0.4	0.5	0.2
Mean value at 20°C	-0.3	-	0.3	-

Table 13: Dependence of the zero point on the surrounding temperature, deviation in  $\mu\text{g}/\text{m}^3$ , average of measurements, per.

Temperature °C	SN 6158		SN 6159	
	Measured value	Deviation to mean value at 20°C	Measured value	Deviation to mean value at 20°C
	$\mu\text{g}/\text{m}^3$	$\mu\text{g}/\text{m}^3$	$\mu\text{g}/\text{m}^3$	$\mu\text{g}/\text{m}^3$
20	-0.6	-0.3	0.3	0.0
5	0.3	0.7	0.1	-0.2
20	0.3	0.7	0.0	-0.2
40	-0.9	-0.6	0.8	0.5
20	-0.7	-0.4	0.5	0.2
Mean value at 20°C	-0.3	-	0.3	-

Schedule 3 in the annex contains the individual measuring results.

## **6.1 8 Dependence of measured value (span) on surrounding temperature (7.4.7)**

*The differences found shall comply with the performance criteria given below.*

*Sensitivity of the measuring system (span):*

*≤ 5% from the value at the nominal test temperature*

- *between 5°C and 40°C by default, for installations in an air-conditioned environment.*
- *at minimum and maximum temperatures specified by the manufacturer if these deviate from the default temperatures.*

## **6.2 Equipment**

Climatic chamber for the temperature range between 5 and +40 °C; internal reference foil for span checks

## **6.3 Testing**

The dependence of the zero reading and span value, measured by applying a calibration artefact on the surrounding temperature, shall be determined at the following temperatures:

- a) at a nominal temperature  $T_{S,n} = +20\text{ °C}$ ;
- b) at a minimum temperature  $T_{S,1} = 5\text{ °C}$
- c) at a maximum temperature  $T_{S,2} = 40\text{ °C}$ .

To test the dependence of the zero point on the surrounding temperature, the complete measuring system was operated in a climatic chamber. For the span checks, the reference foil was mounted on the tested instruments to check the stability of the sensitivity.

At each temperature setting, three separate measurement results shall be recorded at the zero point.

The criteria for the running-in or stabilisation time listed in Section 7.4.2.1 have to be met at each temperature setting.

The tests were performed in the temperature sequence  $T_{S,n} — T_{S,1} — T_{S,n} — T_{S,2} — T_{S,n}$ .

Readings were recorded at span point after an equilibration period of at least 6h for every temperature step (3 readings each).

## **6.4 Evaluation**

Measured values for the concentrations of the individual readings were read and evaluated.

In order to exclude any possible drift due to factors other than temperature, the measurements at  $T_{S,n}$  were averaged.

The differences between readings at both extreme temperatures and  $T_{S,lab}$  were determined.



## 6.5 Assessment

The tested temperature range was 5 °C to 40 °C. The maximum deviation from the mean reading at 20 °C was at 1.8 µg/m<sup>3</sup>.

Criterion satisfied? yes

## 6.6 Detailed presentation of test results

Table 14: Dependence of measured value on surrounding temperature, deviation in %, average from three measurements

Temperature °C	SN 6158		SN 6159	
	Measured value [µg/cm <sup>3</sup> ]	Deviation to mean value at 20°C %	Measured value [µg/cm <sup>3</sup> ]	Deviation to mean value at 20°C %
20	829.6	0.0	836.7	0.2
5	844.2	1.8	846.2	1.3
20	828.9	-0.1	835.0	0.0
40	824.6	-0.6	834.2	-0.1
20	830.1	0.1	834.2	-0.1
Mean value at 20°C	829.6	-	835.3	-

Schedule 3 in the annex contains the results from 3 individual measurements.

## **6.1 9 Dependence of span on supply voltage (7.4.8)**

*The differences found shall comply with the performance criteria given below.*

*Sensitivity of the measuring system (span):*

*≤ 5% from the value at the nominal test voltage*

## **6.2 Equipment**

Isolating transformer, internal reference foil

## **6.3 Testing**

The dependence of the measured value corrected by a calibration factor on the supply voltage must be determined at the following voltages (cf. EN 50160 [10] taking into consideration the manufacturer's specifications:

- at a nominal voltage  $V_{s,n} = 230 \text{ V}$ ;
- at a minimum voltage  $V_{s,1} = 195 \text{ V}$ ;
- at a maximum voltage  $V_{s,2} = 253 \text{ V}$ .

This test item requires the use of calibration equipment for span.

Three individual readings shall be recorded for span at each voltage setting.

The criteria for the running-in or stabilisation time listed in Section 7.4.2.1 have to be met at each voltage setting.

The tests were performed in the voltage sequence  $V_{S,n} - V_{S,1} - V_{S,n} - V_{S,2} - V_{S,n}$ .

For the span checks, the reference foil was mounted on the tested instruments to check the stability of the sensitivity.

## **6.4 Evaluation**

In order to rule out a possible drift caused by factors other than voltage, the measured values were averaged at  $V_{S,n}$ .

The differences between readings at both extreme voltages and  $V_{S,n}$  were determined.

## **6.5 Assessment**

Voltage variations did not cause deviations exceeding 0.9% of the average at 230V at the extreme values.

Criterion satisfied? yes

## 6.6 Detailed presentation of test results

Table 15: Influence of mains voltage on measured value, deviation in %

Supply voltage V	SN 6158		SN 6159	
	Measured value [µg/cm <sup>3</sup> ]	Deviation to start value at 230 V %	Measured value [µg/cm <sup>3</sup> ]	Deviation to start value at 230 V %
230	819.6	0.0	827.1	0.4
195	820.9	0.2	830.8	0.9
230	819.9	0.1	824.8	0.1
253	817.9	-0.2	819.7	-0.5
230	818.6	-0.1	819.4	-0.5
Mean value at 230 V	819.3	-	823.8	-

Schedule 4 in the annex contains the individual results.

### **6.1 10 Effect of failure of mains voltage**

*Instrument parameters shall be secured against loss.  
On return of main voltage the instrument shall automatically resume functioning.*

### **6.2 Equipment**

Not required for this performance criterion

### **6.3 Testing**

A simulated failure in the mains voltage served to test whether the instrument remained fully functional, reached operation mode on return of the mains voltage and retained all instrument parameters completely.

### **6.4 Evaluation**

The measuring system resumes operation after a power failure and the start of the operating system. It is operational after a couple of minutes. All instrument parameters are preserved.

### **6.5 Assessment**

All instrument parameters are secured against loss. On return of mains voltage, the instrument returns to normal operating mode and automatically resumes measuring.

Criterion satisfied? yes

### **6.6 Detailed presentation of test results**

Not applicable.

## 6.1 11 Dependence of reading on water vapour concentration (7.4.9)

*The largest difference in readings between 40% and 90% relative humidity shall fulfil the performance criterion stated below:  
≤ 2.0 µg/m<sup>3</sup> in zero air when cycling relative humidity from 40% to 90% and back.*

## 6.2 Equipment

Climatic chamber c/w humidity control for the range between 40% and 90% relative humidity, zero filter for zero checks

## 6.3 Testing

The dependence of reading on water vapour concentration in the sample air was determined by feeding humidified zero air in the range between 40% and 90% relative humidity. To this effect, the measuring system was operated in the climatic chamber and the relative humidity of the entire surrounding atmosphere was controlled. Sample air, free of suspended particles was supplied to the instruments after fitting two zero filters at either AMS inlet in order to perform zero point checks.

After stabilisation of relative humidity and the concentration values, a reading over an 24h-averaging period at 40% relative humidity was recorded. Within 24h, the relative humidity evenly to 90%. The time to reaching the equilibrium (ramp) and the average concentration reading were recorded. The moisture content was then reduced to 40% gradually over a period of 24 h. Again, the time to reaching the equilibrium (ramp) and the average concentration reading were recorded.

## 6.4 Evaluation

The measured value for the zero level of 24-hour individual measurements at stable humidity levels were obtained and assessed. The characteristic concerned is the largest difference in µg/m<sup>3</sup> between values in the range of 40% to 90% relative humidity.

## 6.5 Assessment

Differences between readings determined at relative humidities of 40% and 90% did not exceed 1.99 µg/m<sup>3</sup>.

Criterion satisfied? yes

## 6.6 Detailed presentation of test results

 Table 16: Dependence of reading on water vapour concentration, deviations in  $\mu\text{g}/\text{m}^3$ , cyc.

rel. Humidity	SN 6158		SN 6159	
	Measured value	Deviation to previous value	Measured value	Deviation to previous value
%	$\mu\text{g}/\text{m}^3$	$\mu\text{g}/\text{m}^3$	$\mu\text{g}/\text{m}^3$	$\mu\text{g}/\text{m}^3$
40	-0.14	-	0.70	-
90	0.34	0.48	1.82	1.12
40	-1.04	-1.39	-0.15	-1.97
Maximum deviation	-1.39		-1.97	

 Table 17: Dependence of reading on water vapour concentration, deviations in  $\mu\text{g}/\text{m}^3$ , per.

rel. Humidity	SN 6158		SN 6159	
	Measured value	Deviation to previous value	Measured value	Deviation to previous value
%	$\mu\text{g}/\text{m}^3$	$\mu\text{g}/\text{m}^3$	$\mu\text{g}/\text{m}^3$	$\mu\text{g}/\text{m}^3$
40	-0.15	-	0.69	-
90	0.34	0.49	1.84	1.15
40	-1.04	-1.38	-0.15	-1.99
Maximum deviation	-1.38		-1.99	

## 6.1 12 Zero checks (7.5.3)

*During the tests, the absolute measured value of the AMS shall not exceed the following criterion:*

*Absolute value  $\leq 3.0 \mu\text{g}/\text{m}^3$*

## 6.2 Equipment

Zero filter for zero checks

## 6.3 Testing

Regular checks of the AMS reading at zero point shall be performed in the field during normal operation over a sufficient time period by using an appropriate method to provide zero air to the AMS. The manufacturer's instructions shall be observed. An appropriate method to generate zero air is the sampling of ambient air through a zero filter (HEPA) installed at the inlet of the AMS instead of the regular sampling inlet. The zero check shall be performed for at least 24 h.

The checks shall be performed at least at the beginning and at the end of each of the 4 comparisons.

## 6.4 Evaluation

During the tests, the absolute measured value of the AMS at zero point defined at  $3.0 \mu\text{g}/\text{m}^3$  shall not be exceeded.

## 6.5 Assessment

The absolute measured value determined at the zero point did not exceed  $0.1 \mu\text{g}/\text{m}^3$ .

Criterion satisfied? yes

## 6.6 Detailed presentation of test results

Table 18: Zero checks, Cyc.

Date	SN 6158		Date	SN 6159	
	Measured Value	Measured value (absolute) < $3.0 \mu\text{g}/\text{m}^3$		Measured Value	Measured value (absolute) < $3.0 \mu\text{g}/\text{m}^3$
	$\mu\text{g}/\text{m}^3$			$\mu\text{g}/\text{m}^3$	
11/30/2017	0.1	ok	11/30/2017	0.0	ok
3/5/2018	1.7	ok	3/5/2018	1.4	ok
3/30/2018	0.4	ok	3/30/2018	0.8	ok
7/3/2018	1.2	ok	7/3/2018	1.0	ok
7/12/2018	2.5	ok	7/12/2018	2.6	ok
11/29/2018	3.0	ok	11/29/2018	2.9	ok
12/13/2018	2.6	ok	12/13/2018	2.1	ok
4/4/2019	1.8	ok	4/4/2019	2.3	ok

Table 19: Zero checks, Per.

Date	SN 6158		Date	SN 6159	
	Measured Value	Measured value (absolute) < 3.0 µg/m³		Measured Value	Measured value (absolute) < 3.0 µg/m³
	µg/m³			µg/m³	
11/30/2017	0.1	ok	11/30/2017	0.0	ok
3/5/2018	1.7	ok	3/5/2018	1.4	ok
3/30/2018	0.4	ok	3/30/2018	0.8	ok
7/3/2018	1.2	ok	7/3/2018	1.0	ok
7/12/2018	2.5	ok	7/12/2018	2.6	ok
11/29/2018	3.0	ok	11/29/2018	2.9	ok
12/13/2018	2.6	ok	12/13/2018	2.1	ok
4/4/2019	1.8	ok	4/4/2019	2.2	ok



## 6.1 13 Recording of operational parameters (7.5.4)

*During the tests the AMS shall be able to telemetrically transmit operational states of – at minimum – the following parameters:*

*Flow rate;*

- *Pressure drop over sample filter (if relevant);*
- *Sampling time;*
- *Sampling volume (if relevant);*
- *Mass concentration of relevant PM fraction(s);*
- *Ambient temperature,*
- *Exterior air pressure,*
- *Air temperature in measuring section,*
- *Temperature of the sampling inlet if a heated inlet is used;*

*When available, results of automatic diagnostic/functional checks shall be recorded.*

## 6.2 Equipment

Computer for data acquisition

## 6.3 Testing

The measuring system allows for comprehensive monitoring and control via various connectors (Ethernet, RS232) and, according to information provided by the manufacturer, is able to output measured values and status information via various protocols (e.g. Bayern-Hessen protocol or serial ASCII)

It is possible to communicate the operating statuses and relevant parameters including:

- Flow rate
- Mass concentrations,
- Ambient temperature, pressure, humidity
- Temperature of the sampling inlet,
- Temperature inside the instrument,
- Various pressures inside the instrument,

All values are saved at 1-minute intervals.

Remote monitoring and control is easily possible via routers or modems. To test this criterion, a network was established and the instrument controlled via a PC.

## 6.4 Evaluation

The measuring system allows for comprehensive monitoring and control via various connectors (Ethernet, RS232). The instrument provides operating statuses and all relevant parameters.

## **6.5 Assessment**

The measuring system allows for comprehensive monitoring and control via various connectors (Ethernet, RS232). The instrument provides operating statuses and all relevant parameters.

Criterion satisfied? yes

## **6.6 Detailed presentation of test results**

Not applicable.

## **6.1 14 Daily averages (7.5.5)**

*The AMS shall allow for the formation of daily averages or values.*

## **6.2 Equipment**

For this test, a clock was additionally provided.

## **6.3 Testing**

We verified whether the measuring system allows for the formation of daily averages.

## **6.4 Evaluation**

The measuring system determines the sampled mass on the filter at hourly intervals. Both the dust concentration for each hour (1 period) and the dust concentration after 24 h (1 cycle = 24 periods) are output and recorded. The filter tape is transported forwards after one cycle to sample a blank filter spot.

## **6.5 Assessment**

It is possible to form valid daily averages.

Criterion satisfied? yes

## **6.6 Detailed presentation of test results**

Not applicable.

## 6.1 15 Availability (7.5.6)

*The availability of the measuring system shall be at least 90%.*

## 6.2 Equipment

Not required for this performance criterion

## 6.3 Testing

The start and end times at each of the four field test sites marked the start and end time for the availability test. Proper operation of the measuring system was verified during every on-site visit (usually every working day). This daily check consisted of plausibility checks on the measured values, status signals and other relevant parameters (see 7.5.4). Time, duration and nature of any error in functioning are recorded.

The total time during the field test in which valid measurement data of ambient air concentrations were obtained was used for calculating availability. Time needed for scheduled calibrations and maintenance (cleaning; change of consumables) should not be included.

Availability is calculated as

$$A = \frac{t_{\text{valid}} + t_{\text{cal,maint}}}{t_{\text{field}}}$$

Where:

$t_{\text{valid}}$  is the time during which valid data have been collected;

$t_{\text{cal,maint}}$  is the time spent for scheduled calibrations and maintenance;

$t_{\text{field}}$  is the total duration of the field test.

## 6.4 Evaluation

Operation times, maintenance and outage times are summarized in Table 20. During the field test, the measuring systems were operated for a total of 419 measuring days. This period covers 18 days with zero filter operation and a seven-day loss caused by switching from the inlet to the zero filter (see annex 5).

Outages caused by external events not ascribed to the measuring system amounted to 5 days (power outage). The externally-caused outages reduce the total time of operation to 414 measuring days.

No instrument malfunctions were observed.

Regular maintenance of the sampling inlets and regular flow and leak tests resulted in outage times of 0.5 to 1h . Daily averages thus affected were not discarded.

## 6.5 Assessment

Availability was at 100% for both instruments.

Criterion satisfied? yes

## 6.6 Detailed presentation of test results

Table 20: Determination of the availability

		System 1 (SN 6158)	System 2 (SN 6159)
Operation time ( $t_{\text{field}}$ )	d	414	414
Outage time	d	0	0
Maintenance time incl. zero filter ( $t_{\text{cal,maint}}$ )	d	18	18
Actual operating time ( $t_{\text{valid}}$ )	d	396	396
Availability	%	100	100

## 6.1 Method used for equivalence testing (7.5.8.4 & 7.5.8.8)

Standard EN 16450 [4] requires compliance with the following five criteria:

1. Of the full data set, at least 20% of the concentration values (determined with the reference method) shall be greater than  $28 \mu\text{g}/\text{m}^3$  for  $\text{PM}_{10}$  and  $17 \mu\text{g}/\text{m}^3$  for  $\text{PM}_{2.5}$ . When due to low concentration levels, the criteria for 20 % of results to be greater than  $28 \mu\text{g}/\text{m}^3$  for  $\text{PM}_{10}$ , or to be greater than  $17 \mu\text{g}/\text{m}^3$  for  $\text{PM}_{2.5}$  cannot be obtained, a minimum of 32 data points higher than these thresholds is considered sufficient.
2. Between-AMS uncertainty shall remain below  $2.5 \mu\text{g}/\text{m}^3$  for the overall data and for data sets with data larger than/equal to  $30 \mu\text{g}/\text{m}^3$   $\text{PM}_{10}$  and  $18 \mu\text{g}/\text{m}^3$   $\text{PM}_{2.5}$ .
3. The uncertainty between reference systems shall not exceed  $2.0 \mu\text{g}/\text{m}^3$ .
4. The expanded uncertainty ( $W_{\text{CM}}$ ) is calculated at  $50 \mu\text{g}/\text{m}^3$  for  $\text{PM}_{10}$  and at  $30 \mu\text{g}/\text{m}^3$  for  $\text{PM}_{2.5}$  for every individual test specimen and checked against the average of the reference method. For each of the following cases, the expanded uncertainty shall not exceed 25%:
  - Full data set:
  - datasets representing PM concentrations greater than/equal to  $30 \mu\text{g}/\text{m}^3$  for  $\text{PM}_{10}$ , or concentrations greater than/equal to  $18 \mu\text{g}/\text{m}^3$  for  $\text{PM}_{2.5}$ , provided that the set contains 40 or more valid data pairs
  - Datasets for each individual site
5. Preconditions for acceptance of the full dataset are that the slope  $b$  is insignificantly different from 1:  $|b - 1| \leq 2 \cdot u(b)$  and the intercept  $a$  is insignificantly different from 0:  $|a| \leq 2 \cdot u(a)$ . If these preconditions are not met, the candidate method may be calibrated using the values obtained for slope and/or intercept.

The following chapter address the issue of verifying compliance with the five criteria.

Chapter 6.1 16 Between-AMS uncertainty (7.5.8.4) addresses verification of criteria 1 and 2.

Verification of criteria 3, 4 and 5 is reported on in chapter 6.1 17 Expanded uncertainty (7.5.8.5 – 7.5.8.8)

Chapter 6.1 17 Use of correction factors/terms (7.5.8.5–7.5.8.8) contains an assessment for the case that criterion 5 is not complied with without applying correction factors.

## 6.1 16 Between-AMS uncertainty (7.5.8.4)

*The between-AMS uncertainty  $u_{bs}$  shall be  $\leq 2.5 \mu\text{g}/\text{m}^3$ .*

## 6.2 Equipment

Not required for this performance criterion

## 6.3 Testing

The test was performed as part of the field test with four separate comparison campaigns. Different seasons as well as different concentrations of PM<sub>10</sub> were taken into consideration.

In the full dataset, at least 20% of the results obtained using the reference method should be greater than 28  $\mu\text{g}/\text{m}^3$  for PM<sub>10</sub>. Should this not be assured because of low concentration levels, a minimum of 32 value pairs is considered sufficient.

For each comparison campaign, at least 40 valid value pairs were determined. In the full dataset a total of 26.4% value pairs (corresponds to 55 > 32 value pairs) exceed 28  $\mu\text{g}/\text{m}^3$  for PM<sub>10</sub>. The concentrations measured were related to the ambient conditions.

During the test, both instruments were also equipped with what is referred to as a CPM+ module. This CPM+ module is an additional optical scattered light sensor for the determination of PM<sub>2.5</sub>. The CPM+ module is mounted directly to the central unit of the sampling tube. The sample stream is passed straight through the CPM+ module to the MP101M analyser without deflection from the sampling tube. The CPM+ module is not included in the scope of the certification. To demonstrate the CPM+ module does not affect the measuring results determined for PM<sub>10</sub>, it was removed from instrument 6159 after 4 field test campaigns. An additional field test was then performed and the between-AMS uncertainty compared between the instruments with and without the CPM+ module ( $u_{bs,AMS}$ ).

## 6.4 Evaluation

Chapter 7.5.8.4 of standard EN 16450 specifies that:

The between-AMS uncertainty  $u_{bs}$  shall be  $\leq 2.5 \mu\text{g}/\text{m}^3$ . A between-AMS uncertainty > 2.5  $\mu\text{g}/\text{m}^3$  is an indication of unsuitable performance of one or both instruments, and equivalence should not be stated.

Uncertainty is determined for:

- All results combined (complete dataset)
- 1 data set with measured values  $\geq 18 \mu\text{g}/\text{m}^3$  for PM<sub>2.5</sub> (basis: averages reference measurement)
- 1 data set with measured values  $\geq 30 \mu\text{g}/\text{m}^3$  for PM<sub>10</sub> (basis: averages reference measurement)

The between-AMS uncertainty  $u_{bs}$  is calculated from the differences of all daily averages (24h-values) of the AMS which are operated simultaneously as:

$$u_{bs,AMS}^2 = \frac{\sum_{i=1}^n (y_{i,1} - y_{i,2})^2}{2n}$$

Where:  $y_{i,1}$  and  $y_{i,2}$  = Results of the parallel measurements of individual 24h-values  $i$   
 $n$  = Number of 24h-values

### 6.5 Assessment

At no more than  $0.95 \mu\text{g}/\text{m}^3$  the uncertainty between the test specimen  $u_{bs}$  remains well below the permissible maximum of  $2.5 \mu\text{g}/\text{m}^3$ .

Criterion satisfied?  yes

The comparison between the situation with and without the CPM+ module did not reveal any significant change in the uncertainty. Thus, the CPM+ module does not affect the readings of the downstream measuring system.

### 6.6 Detailed presentation of test results

Table 21: Between-AMS uncertainty  $u_{bs,AMS}$ .

Location	Number of measurements	Uncertainty $u_{bs,AMS}$	
		$\mu\text{g}/\text{m}^3$	
		Cyc.	Per.
<b>All locations</b>	<b>208</b>	<b>0.94</b>	<b>0.95</b>
Classing over reference values			
<b>Values <math>\geq 30 \mu\text{g}/\text{m}^3</math></b>	<b>44</b>	<b>1.13</b>	<b>1.14</b>
<b>Additional test to compare results with/without CPM+ module</b>			
	<b>35</b>	<b>1.12</b>	<b>1.14</b>



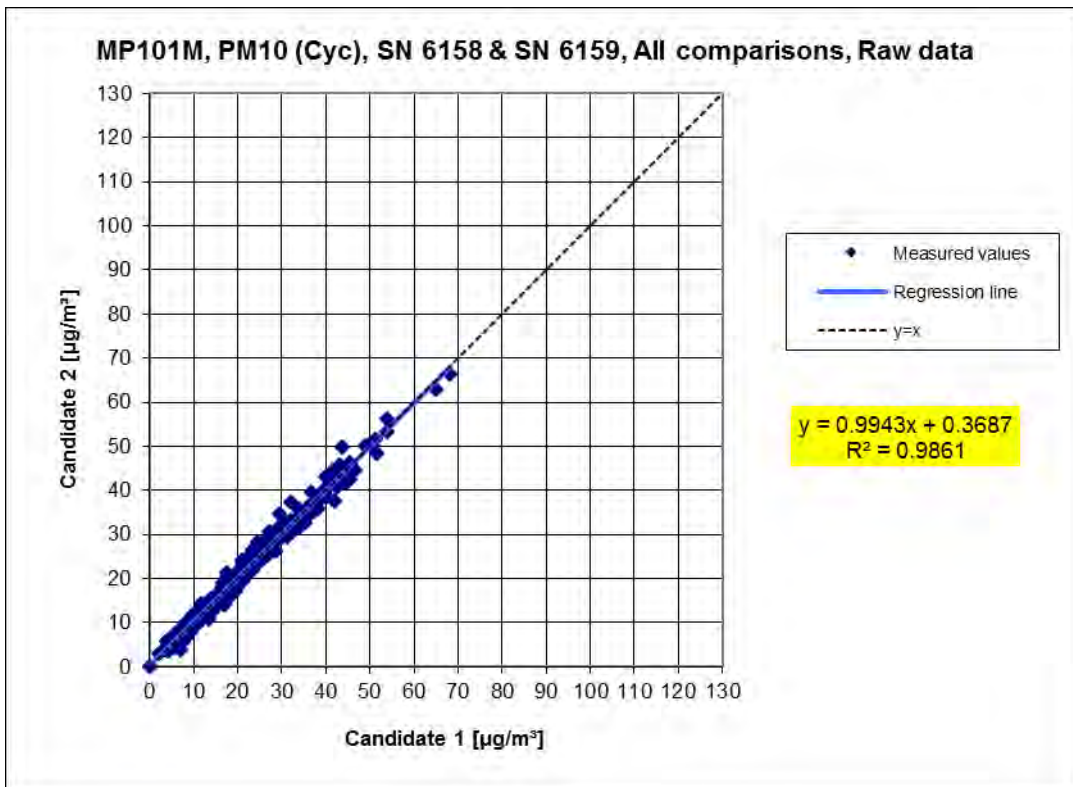


Figure 15: Results of the parallel measurements, all sites, Cyc.

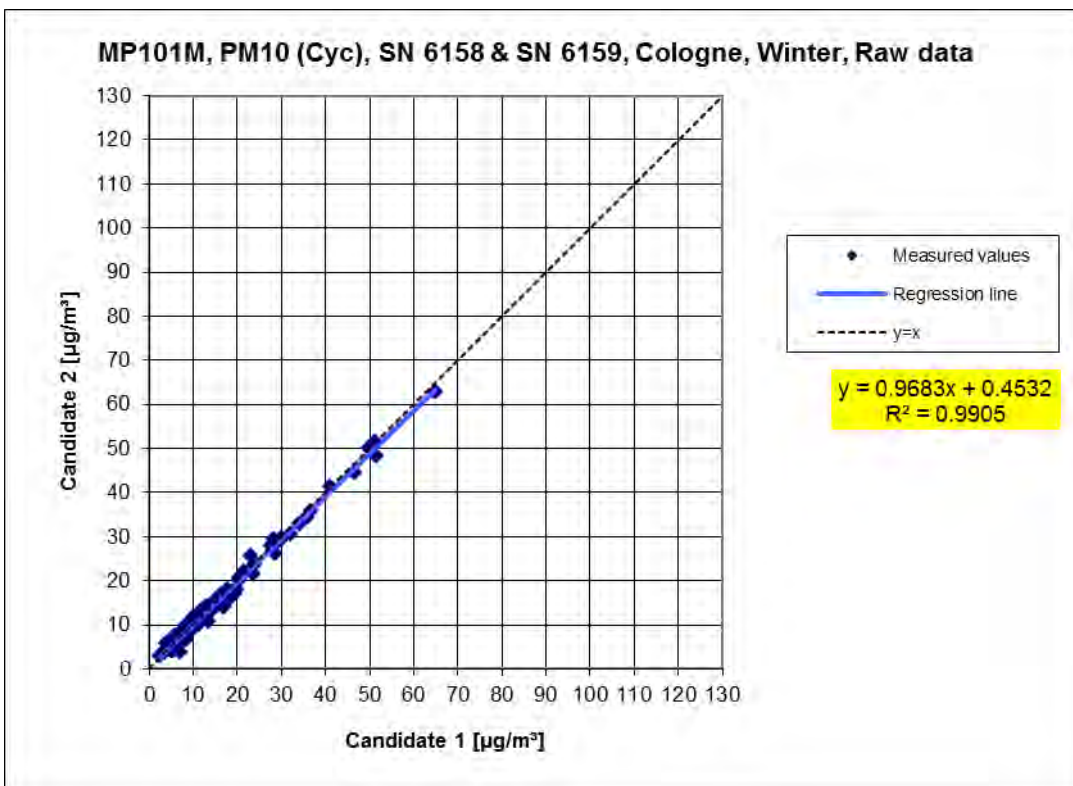


Figure 16: Results of the parallel measurements, Cologne, winter, Cyc.

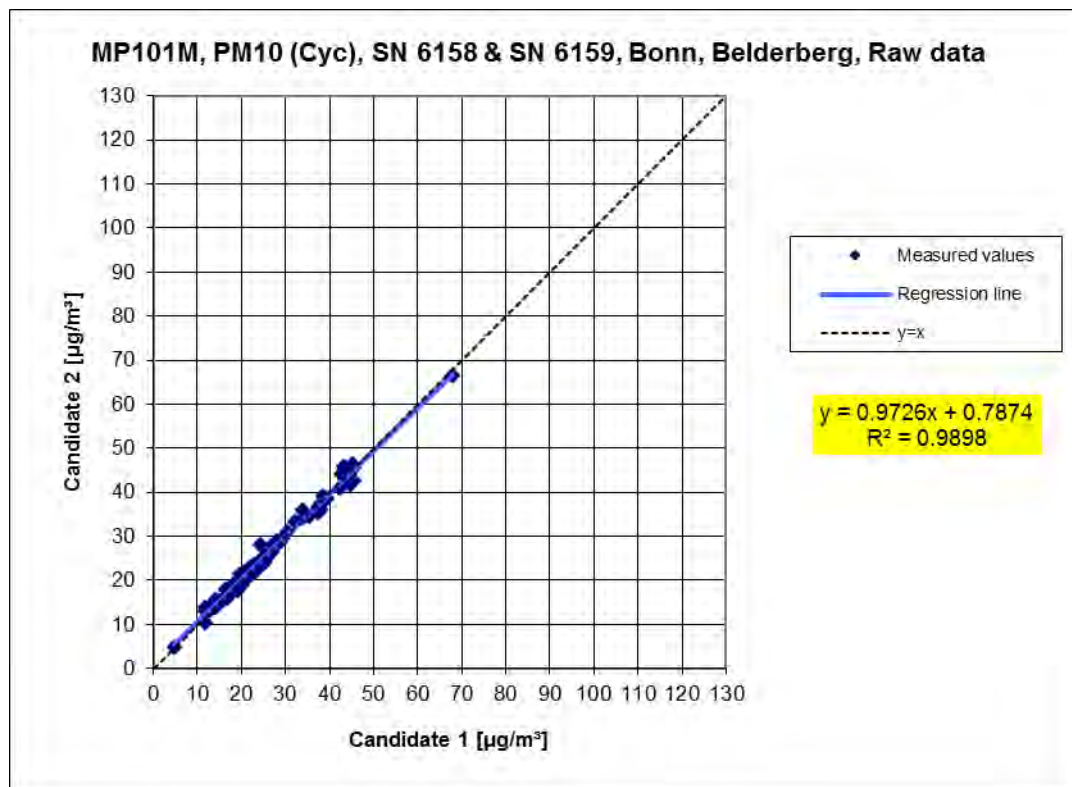


Figure 17: Results of the parallel measurements, Bonn-Belderberg, Cyc.

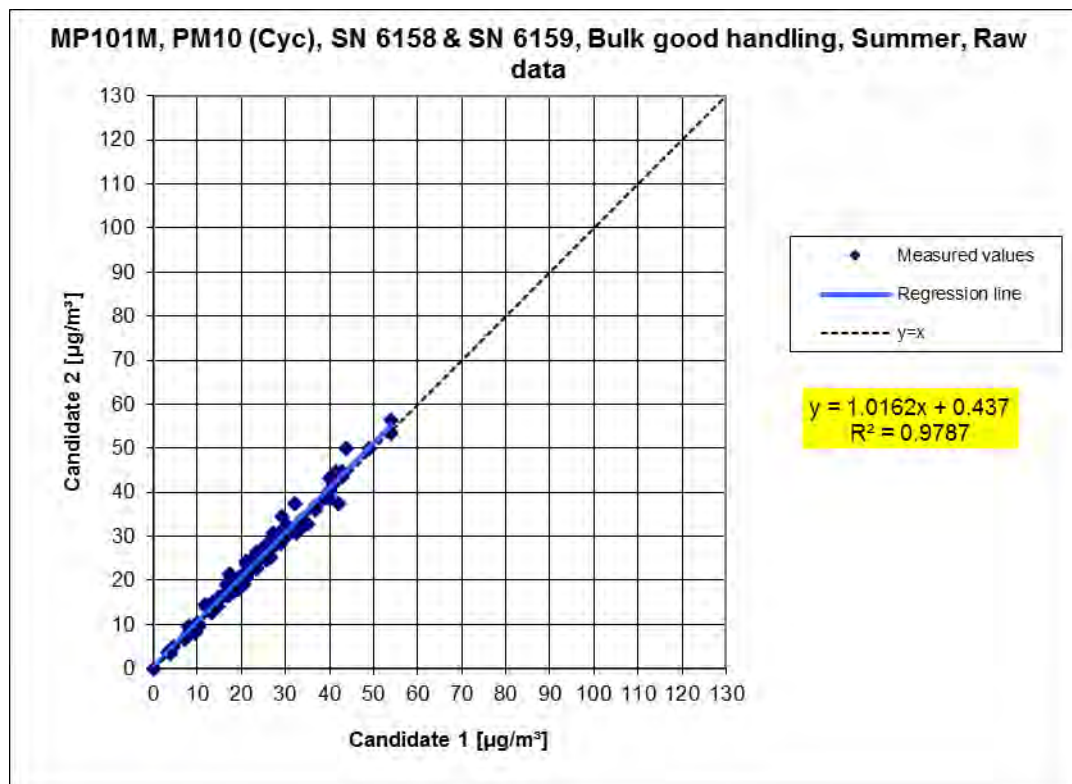


Figure 18: Results of the parallel measurements, bulk handling, summer, Cyc.

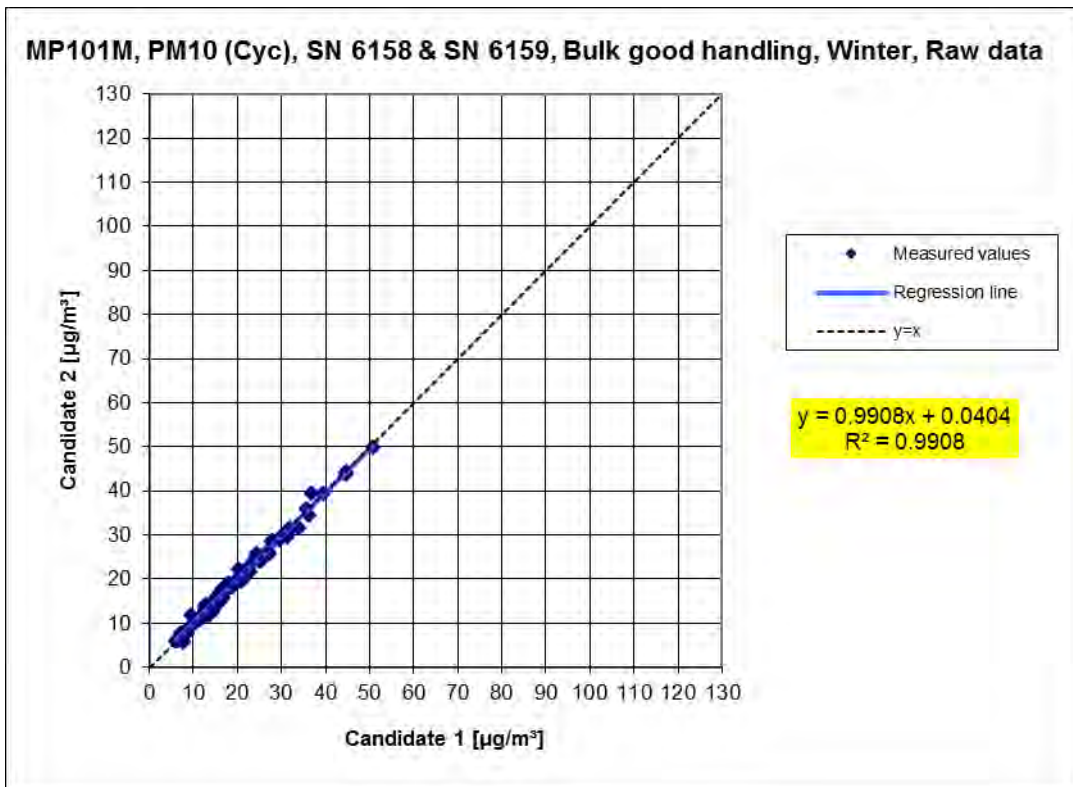


Figure 19: Results of the parallel measurements, bulk handling, winter, Cyc.

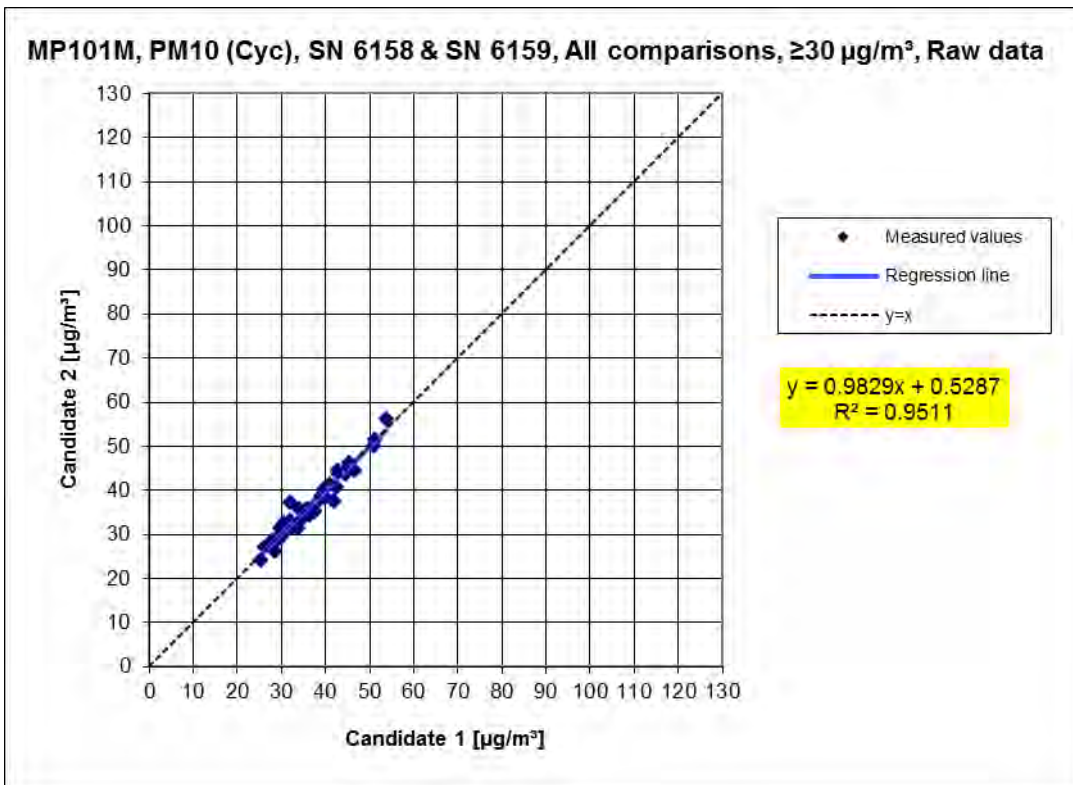


Figure 20: Results of the parallel measurements, all sites, values  $\geq 30 \mu\text{g}/\text{m}^3$ , Cyc.



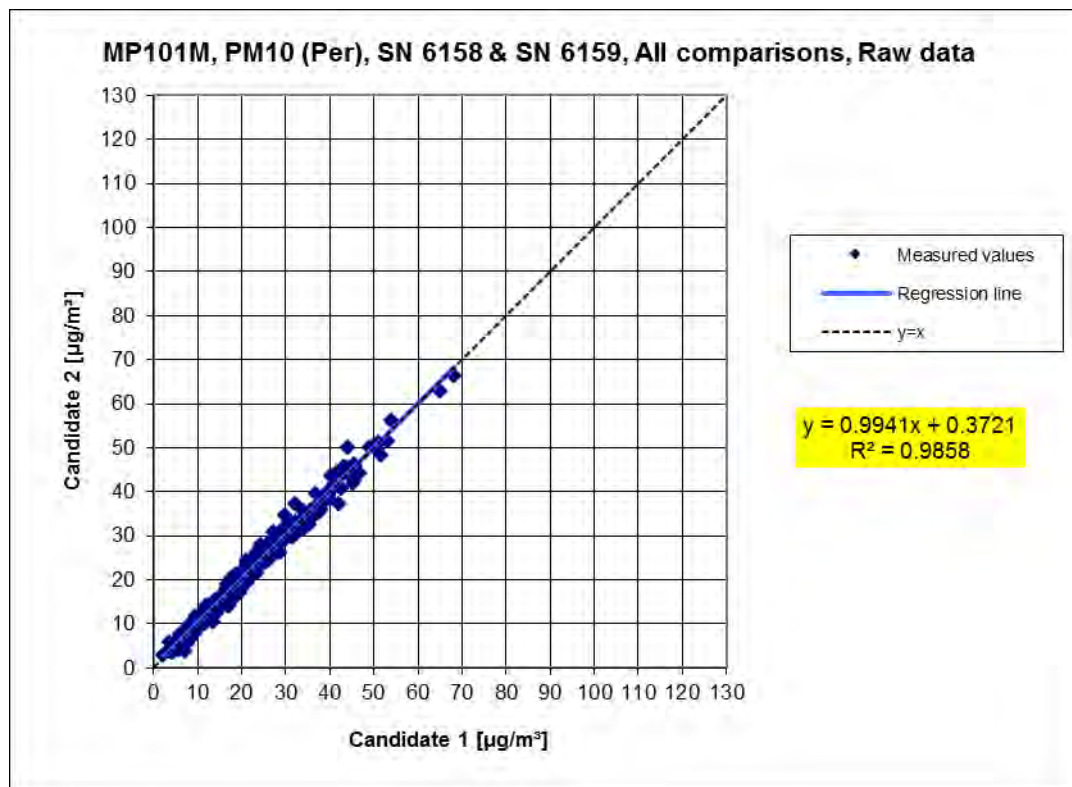


Figure 21: Results of the parallel measurements, all sites, per.

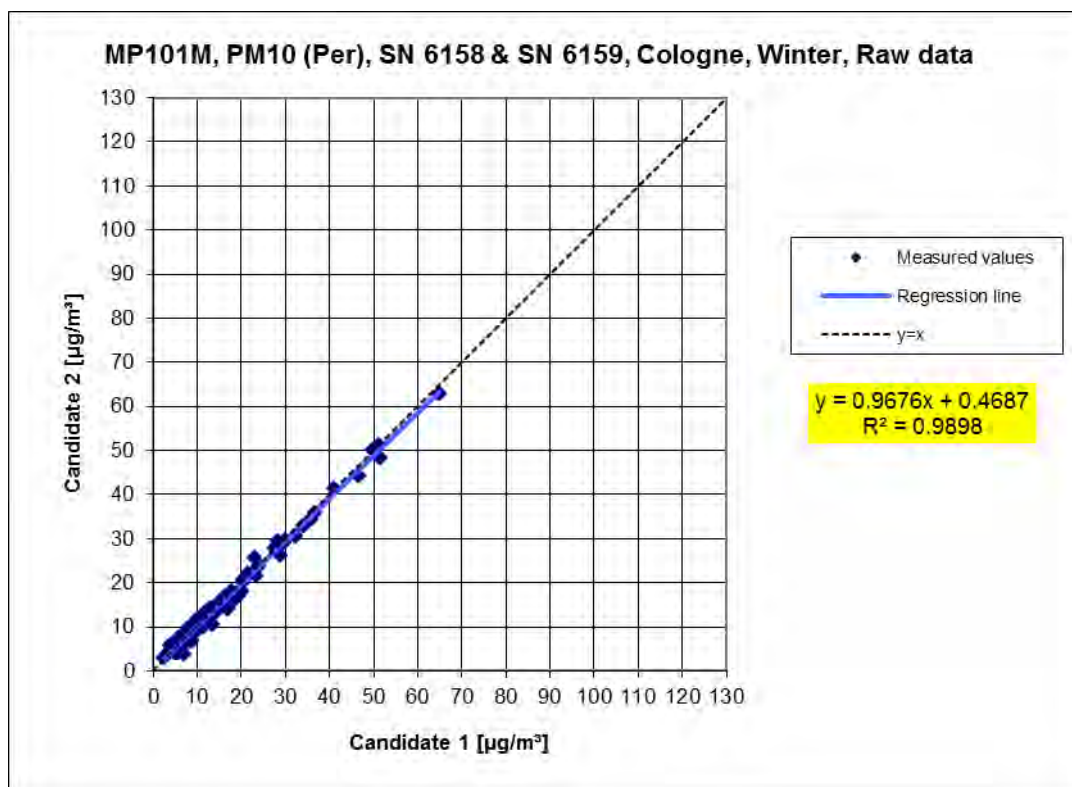


Figure 22: Results of the parallel measurements, Cologne, winter, per.

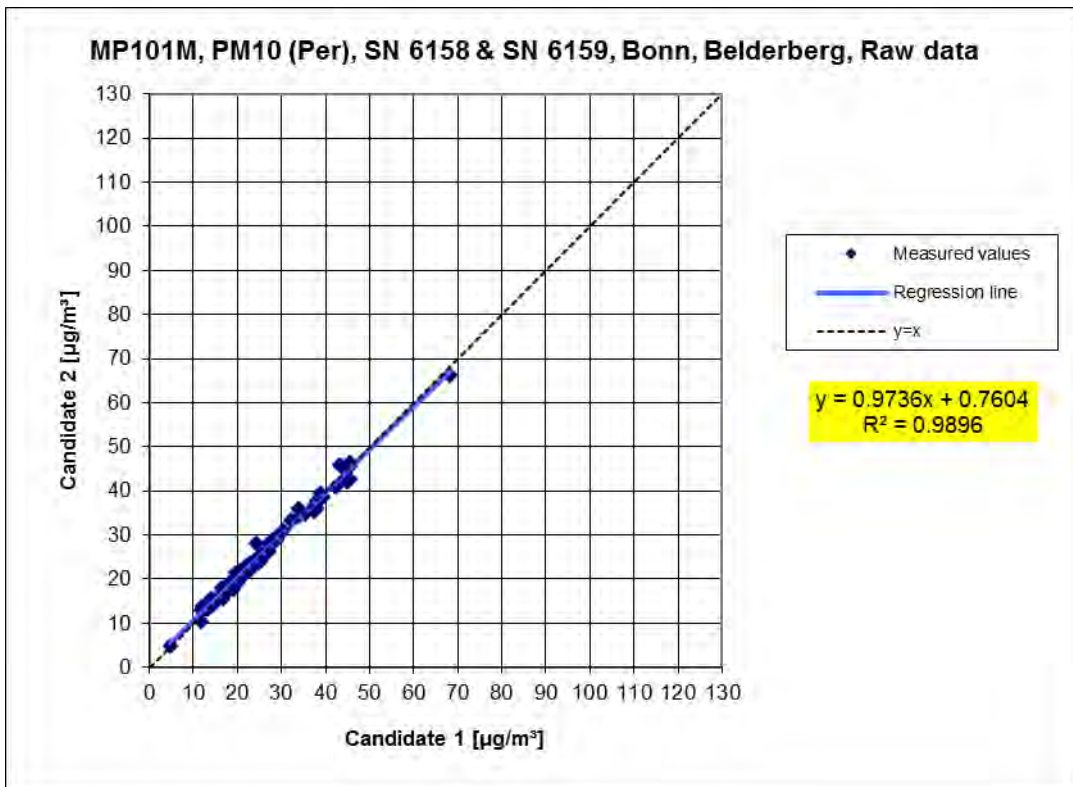


Figure 23: Results of the parallel measurements, Bonn-Belderberg, per.

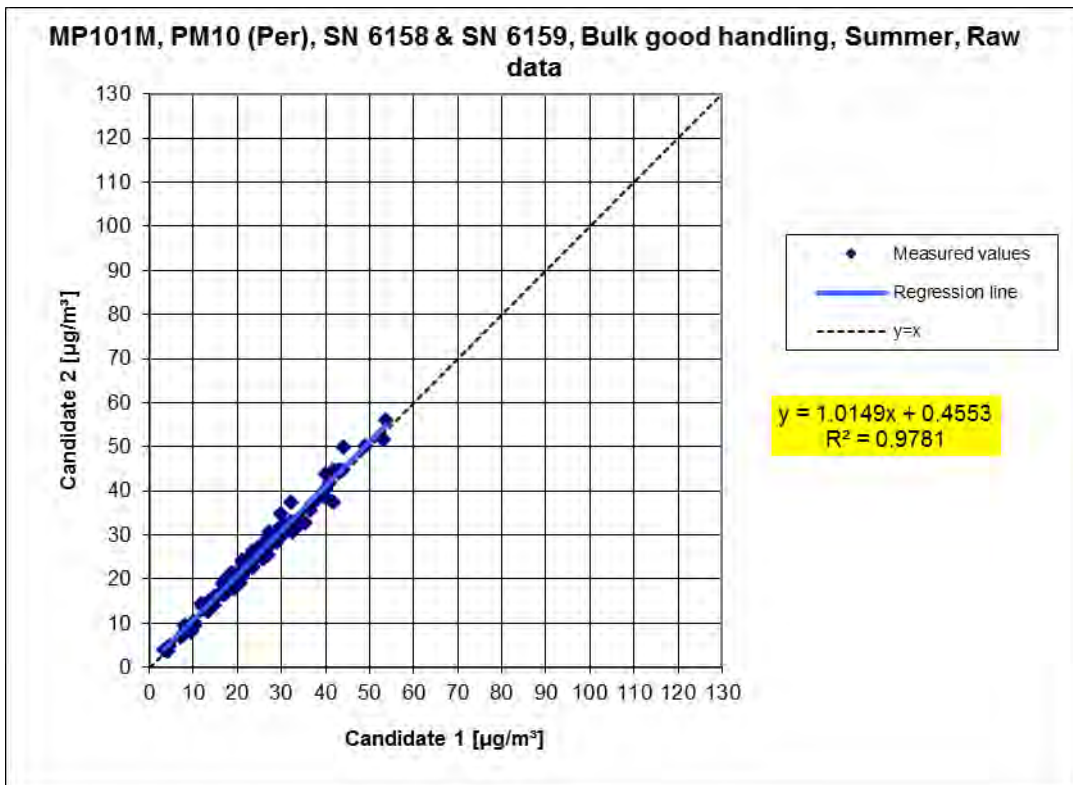


Figure 24: Results of the parallel measurements, bulk handling, summer, per.

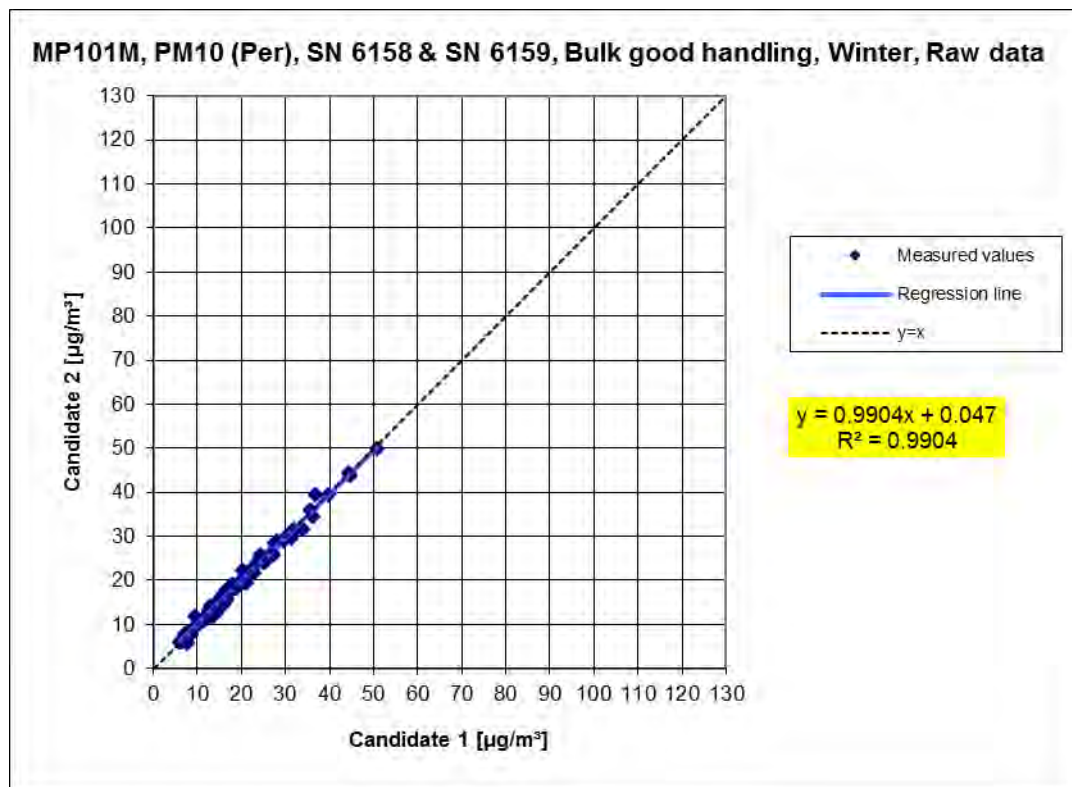


Figure 25: Results of the parallel measurements, bulk handling, winter, per.

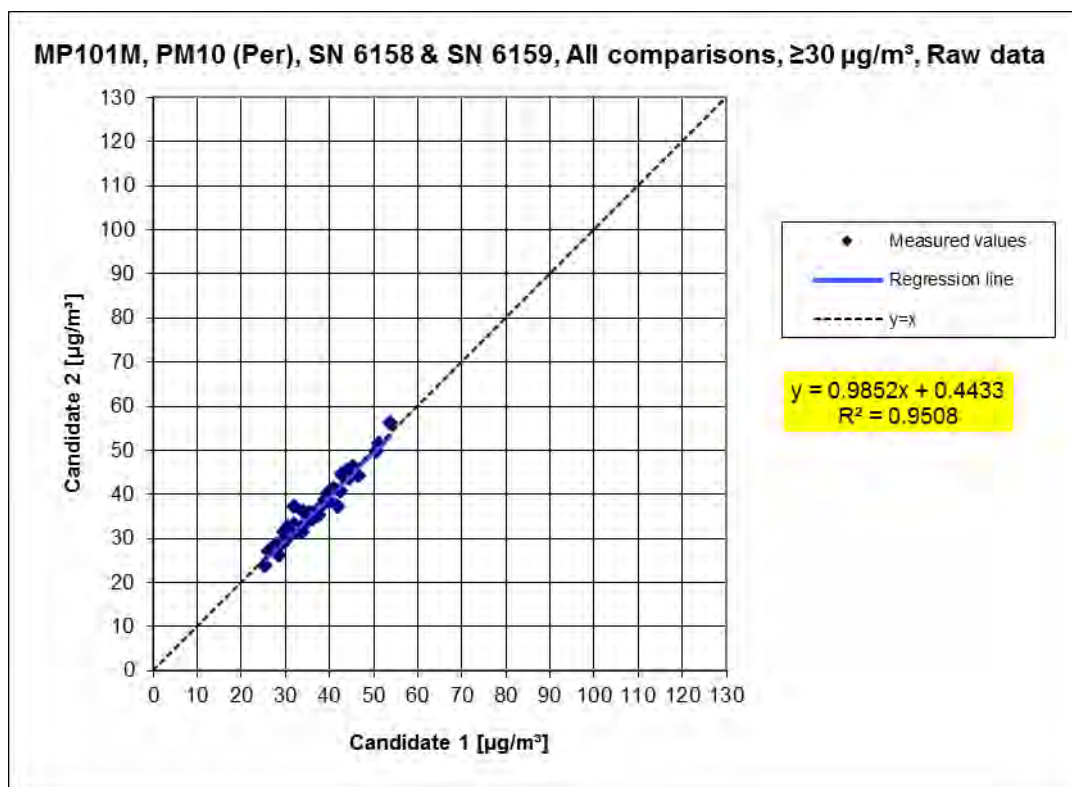


Figure 26: Results of the parallel measurements, all sites, values  $\geq 30 \mu\text{g}/\text{m}^3$ , per.

## 6.1 17 Expanded uncertainty (7.5.8.5 – 7.5.8.8)

*The expanded uncertainty shall be  $\leq 25\%$  at the level of the relevant limit value related to the 24-hour average results – after a calibration where necessary.*

## 6.2 Equipment

Additional reference measurement system as described in chapter 5 of this report was used for this test.

## 6.3 Testing

The test was performed as part of the field test with four separate comparison campaigns. Different seasons as well as different concentrations of PM<sub>2.5</sub> and PM<sub>10</sub> were taken into consideration.

In the full dataset, at least 20% of the results obtained using the reference method should be greater than 28  $\mu\text{g}/\text{m}^3$  for PM<sub>10</sub>. Should this not be assured because of low concentration levels, a minimum of 32 value pairs is considered sufficient.

For each comparison campaign, at least 40 valid value pairs were determined. In the full dataset a total of 26.4% value pairs (corresponds to 55 > 32 value pairs) exceed 28  $\mu\text{g}/\text{m}^3$  for PM<sub>10</sub>. The concentrations measured were related to the ambient conditions.

## 6.4 Evaluation

[EN 16450, 7.5.8.3]

Before calculating the expanded uncertainty of the test specimens, uncertainties were established between the simultaneously operated reference measuring systems ( $u_{\text{ref}}$ )

Uncertainties between the simultaneously operated reference measuring systems  $u_{\text{bs, RM}}$  were established similar to the between-AMS uncertainties and shall be  $\leq 2.0 \mu\text{g}/\text{m}^3$ .

Results of the evaluation are summarised in section 6.6.

[EN 16450, 7.5.8.5 & 7.5.8.6]

In order to assess comparability of the tested instruments  $y$  with the reference method  $x$ , a linear relationship  $y_i = a + bx_i$  between the measured values of both methods is assumed. The association between the means of the reference systems and each individual test specimen to be assessed is established by means of orthogonal regression.

The regression is calculated for:

- all sites or comparisons respectively together
- Every location or comparison separately
- For a reduced data set only taking into account concentrations greater than or equal to 30  $\mu\text{g}/\text{m}^3$  for PM<sub>10</sub>, provided that the subset contains 40 or more valid data pairs.



For further assessment, the uncertainty  $u_{c,s}$  resulting from a comparison of the test specimens with the reference method is described in the following equation which defines  $u_{CR}$  as a function of the fine dust concentration  $x_i$ .

$$u_{yi}^2 = \frac{RSS}{(n-2)} - u_{RM}^2 + [a + (b-1)L]^2$$

Where  $RSS$  is the sum of the (relative) residuals from orthogonal regression

$u_{RM}$  = random uncertainty of the reference method;  $u_{RM}$  is calculated as  $u_{bs,RM}/\sqrt{2}$ , where  $u_{bs,RM}$  is the between RM uncertainty of two reference instruments operated in parallel.

$L$  = daily limit for  $PM_{10}$  ( $50 \mu\text{g}/\text{m}^3$ )

The algorithms for calculating axis intercept  $a$  and slope  $b$  as well as their variance by means of orthogonal regression are described in detail in the annex to [4].

The sum of (relative) residuals  $RSS$  is calculated according to the following equation:

$$RSS = \sum_{i=1}^n (y_i - a - bx_i)^2$$

Uncertainty  $u_{CR}$  is calculated for:

- all sites or comparisons respectively together
- Every location or comparison separately
- For a reduced data set only taking into account concentrations greater than or equal to  $30 \mu\text{g}/\text{m}^3$  for  $PM_{10}$ , or concentrations greater than or equal to  $18 \mu\text{g}/\text{m}^3$  for  $PM_{10}$  provided that the subset contains 40 or more valid data pairs.

The Guideline states the following prerequisite for accepting the full data set:

- The slope  $b$  is insignificantly different from 1:  $|b-1| \leq 2 \cdot u(b)$
- and
- The axis intercept  $a$  is insignificantly different from 0:  $|a| \leq 2 \cdot u(a)$ ,

where  $u(a)$  and  $u(b)$  describe the standard uncertainty of the slope and the axis intercept calculated as the square root of the variance. If the prerequisites are not met, it is possible to calibrate the measuring systems in accordance with section 4 of the Guideline 7.5.8.6 [4] (also see 6.1 17 Use of correction factors/terms). The calibration may only be performed for the full data set.

[EN 16450 section 7.5.8.7] The combined uncertainty of the tested instruments for all data sets  $w_{AMS}^2$  is calculated as follows:

$$w_{AMS}^2 = \frac{u_{yi=L}^2}{L^2}$$



For each data set the uncertainty  $w_{AMS}$  is calculated at a level of  $L = 30 \mu\text{g}/\text{m}^3$  for  $\text{PM}_{2.5}$  as well as  $L = 50 \mu\text{g}/\text{m}^3$  for  $\text{PM}_{10}$ .

[EN 16450 7.5.8.8] For each data set the expanded relative uncertainty of the results measured with the test specimen is calculated by multiplying  $w_{AMS}$  by an coverage factor  $k$  according to the following equation:

$$W_{AMS} = k \cdot w_{AMS}$$

Considering the large number of available test results, an expansion factor  $k=2$  must be used.

## 7.5 Assessment

Without the need for any correction factors, the expanded uncertainties  $W_{AMS}$  were below the expanded, relative uncertainty  $W_{dqo}$  defined for fine dust at 25% for all data sets observed. As the axis intercept determined for system 1 is significantly different from 0, section 6.1

17 Use of correction factors/terms required the use of a correction factor.

Criterion satisfied?  yes

Table 22 and Table 23 below summarise all results for the equivalence tests. This page presents the combined results for the two instruments obtained at all 4 sites for all values  $\geq 30 \mu\text{g}/\text{m}^3$ . The following page summarises the results separately for each instrument and site for all values  $\geq 30 \mu\text{g}/\text{m}^3$  and fro all 4 sites.

Where a criterion was not satisfied, the corresponding line is marked in red.

Table 22: Overview of equivalence testing, cyc.

Comparison candidate with reference according to Standard EN 16450:2017				
Candidate	MP101M, PM10 (Cyc)	SN	SN 6158 & SN 6159	
Status of measured values	Raw data	Limit value	50	$\mu\text{g}/\text{m}^3$
		Allowed uncertainty	25	%
<b>All comparisons</b>				
Uncertainty between Reference	0.62	$\mu\text{g}/\text{m}^3$		
Uncertainty between Candidates	0.94	$\mu\text{g}/\text{m}^3$		
<b>SN 6158 &amp; SN 6159</b>				
Number of data pairs	208			
Slope b	1.027	not significant		
Uncertainty of b	0.019			
Ordinate intercept a	-0.859	not significant		
Uncertainty of a	0.468			
Expanded measured uncertainty WCM	11.33	%		
<b>All comparisons, <math>\geq 30 \mu\text{g}/\text{m}^3</math></b>				
Uncertainty between Reference	0.81	$\mu\text{g}/\text{m}^3$		
Uncertainty between Candidates	1.13	$\mu\text{g}/\text{m}^3$		
<b>SN 6158 &amp; SN 6159</b>				
Number of data pairs	44			
Slope b	1.043			
Uncertainty of b	0.080			
Ordinate intercept a	-2.379			
Uncertainty of a	3.020			
Expanded measured uncertainty WCM	14.91	%		

Comparison candidate with reference according to Standard EN 16450:2017				
Candidate	MP101M, PM10 (Cyc)		SN	SN 6158 & SN 6159
Status of measured values	Raw data		Limit value	50 $\mu\text{g}/\text{m}^3$
			Allowed uncertainty	25 %
<b>Cologne, Winter</b>				
Uncertainty between Reference	0.40		$\mu\text{g}/\text{m}^3$	
Uncertainty between Candidates	0.86		$\mu\text{g}/\text{m}^3$	
	<b>SN 6158</b>		<b>SN 6159</b>	
Number of data pairs	57			57
Slope b	0.967			0.936
Uncertainty of b	0.026			0.024
Ordinate intercept a	-1.365			-0.862
Uncertainty of a	0.572			0.533
Expanded measured uncertainty $W_{CM}$	14.91	%		18.25 %
<b>Bonn, Belderberg</b>				
Uncertainty between Reference	0.94		$\mu\text{g}/\text{m}^3$	
Uncertainty between Candidates	0.77		$\mu\text{g}/\text{m}^3$	
	<b>SN 6158</b>		<b>SN 6159</b>	
Number of data pairs	40			40
Slope b	1.026			1.028
Uncertainty of b	0.027			0.032
Ordinate intercept a	0.527			0.643
Uncertainty of a	0.703			0.808
Expanded measured uncertainty $W_{CM}$	9.05	%		10.38 %
<b>Bulk good handling, Summer</b>				
Uncertainty between Reference	0.60		$\mu\text{g}/\text{m}^3$	
Uncertainty between Candidates	1.21		$\mu\text{g}/\text{m}^3$	
	<b>SN 6158</b>		<b>SN 6159</b>	
Number of data pairs	66			66
Slope b	1.116			1.109
Uncertainty of b	0.045			0.036
Ordinate intercept a	-1.746			-0.942
Uncertainty of a	1.111			0.888
Expanded measured uncertainty $W_{CM}$	20.16	%		20.40 %
<b>Bulk good handling, Winter</b>				
Uncertainty between Reference	0.50		$\mu\text{g}/\text{m}^3$	
Uncertainty between Candidates	0.65		$\mu\text{g}/\text{m}^3$	
	<b>SN 6158</b>		<b>SN 6159</b>	
Number of data pairs	45			45
Slope b	0.931			0.919
Uncertainty of b	0.033			0.033
Ordinate intercept a	0.174			0.146
Uncertainty of a	0.852			0.834
Expanded measured uncertainty $W_{CM}$	16.38	%		18.31 %
<b>All comparisons, <math>\geq 30 \mu\text{g}/\text{m}^3</math></b>				
Uncertainty between Reference	0.81		$\mu\text{g}/\text{m}^3$	
Uncertainty between Candidates	1.13		$\mu\text{g}/\text{m}^3$	
	<b>SN 6158</b>		<b>SN 6159</b>	
Number of data pairs	44			44
Slope b	1.045			1.056
Uncertainty of b	0.080			0.084
Ordinate intercept a	-2.433			-2.911
Uncertainty of a	3.020			3.17
Expanded measured uncertainty $W_{CM}$	14.89	%		15.70 %
<b>All comparisons</b>				
Uncertainty between Reference	0.62		$\mu\text{g}/\text{m}^3$	
Uncertainty between Candidates	0.94		$\mu\text{g}/\text{m}^3$	
	<b>SN 6158</b>		<b>SN 6159</b>	
Number of data pairs	208			208
Slope b	1.032	not significant		1.027 not significant
Uncertainty of b	0.020			0.020
Ordinate intercept a	-1.041	significant		-0.766 not significant
Uncertainty of a	0.478			0.482
Expanded measured uncertainty $W_{CM}$	11.61	%		11.70 %

Table 23: Overview of equivalence testing, per.

Comparison candidate with reference according to Standard EN 16450:2017			
Candidate	MP101M, PM10 (Per)	SN	SN 6158 & SN 6159
Status of measured values	Raw data	Limit value	50 $\mu\text{g}/\text{m}^3$
		Allowed uncertainty	25 %
<b>All comparisons</b>			
Uncertainty between Reference	0.62		$\mu\text{g}/\text{m}^3$
Uncertainty between Candidates	0.95		$\mu\text{g}/\text{m}^3$
<b>SN 6158 &amp; SN 6159</b>			
Number of data pairs	208		
Slope b	1.029		not significant
Uncertainty of b	0.019		
Ordinate intercept a	-0.882		not significant
Uncertainty of a	0.474		
Expanded measured uncertainty WCM	11.50		%
<b>All comparisons, <math>\geq 30 \mu\text{g}/\text{m}^3</math></b>			
Uncertainty between Reference	0.81		$\mu\text{g}/\text{m}^3$
Uncertainty between Candidates	1.14		$\mu\text{g}/\text{m}^3$
<b>SN 6158 &amp; SN 6159</b>			
Number of data pairs	44		
Slope b	1.047		
Uncertainty of b	0.081		
Ordinate intercept a	-2.545		
Uncertainty of a	3.079		
Expanded measured uncertainty WCM	15.21		%

Comparison candidate with reference according to Standard EN 16450:2017				
Candidate	MP101M, PM10 (Per)		SN	SN 6158 & SN 6159
Status of measured values	Raw data		Limit value	50 $\mu\text{g}/\text{m}^3$
			Allowed uncertainty	25 %
<b>Cologne, Winter</b>				
Uncertainty between Reference	0.40		$\mu\text{g}/\text{m}^3$	
Uncertainty between Candidates	0.89		$\mu\text{g}/\text{m}^3$	
	<b>SN 6158</b>		<b>SN 6159</b>	
Number of data pairs	57			57
Slope b	0.968			0.936
Uncertainty of b	0.026			0.024
Ordinate intercept a	-1.377			-0.869
Uncertainty of a	0.577			0.538
Expanded measured uncertainty $W_{CM}$	14.96	%		18.36 %
<b>Bonn, Belderberg</b>				
Uncertainty between Reference	0.94		$\mu\text{g}/\text{m}^3$	
Uncertainty between Candidates	0.78		$\mu\text{g}/\text{m}^3$	
	<b>SN 6158</b>		<b>SN 6159</b>	
Number of data pairs	40			40
Slope b	1.033			1.039
Uncertainty of b	0.029			0.034
Ordinate intercept a	0.389			0.420
Uncertainty of a	0.753			0.876
Expanded measured uncertainty $W_{CM}$	10.10	%		11.78 %
<b>Bulk good handling, Summer</b>				
Uncertainty between Reference	0.60		$\mu\text{g}/\text{m}^3$	
Uncertainty between Candidates	1.20		$\mu\text{g}/\text{m}^3$	
	<b>SN 6158</b>		<b>SN 6159</b>	
Number of data pairs	66			66
Slope b	1.116			1.109
Uncertainty of b	0.045			0.036
Ordinate intercept a	-1.721			-0.934
Uncertainty of a	1.116			0.894
Expanded measured uncertainty $W_{CM}$	20.20	%		20.45 %
<b>Bulk good handling, Winter</b>				
Uncertainty between Reference	0.50		$\mu\text{g}/\text{m}^3$	
Uncertainty between Candidates	0.67		$\mu\text{g}/\text{m}^3$	
	<b>SN 6158</b>		<b>SN 6159</b>	
Number of data pairs	45			45
Slope b	0.930			0.918
Uncertainty of b	0.034			0.033
Ordinate intercept a	0.209			0.164
Uncertainty of a	0.858			0.841
Expanded measured uncertainty $W_{CM}$	16.47	%		18.42 %
<b>All comparisons, <math>\geq 30 \mu\text{g}/\text{m}^3</math></b>				
Uncertainty between Reference	0.81		$\mu\text{g}/\text{m}^3$	
Uncertainty between Candidates	1.14		$\mu\text{g}/\text{m}^3$	
	<b>SN 6158</b>		<b>SN 6159</b>	
Number of data pairs	44			44
Slope b	1.049			1.062
Uncertainty of b	0.081			0.085
Ordinate intercept a	-2.542			-3.149
Uncertainty of a	3.066			3.24
Expanded measured uncertainty $W_{CM}$	15.13	%		16.08 %
<b>All comparisons</b>				
Uncertainty between Reference	0.62		$\mu\text{g}/\text{m}^3$	
Uncertainty between Candidates	0.95		$\mu\text{g}/\text{m}^3$	
	<b>SN 6158</b>		<b>SN 6159</b>	
Number of data pairs	208			208
Slope b	1.034	not significant		1.028 not significant
Uncertainty of b	0.020			0.020
Ordinate intercept a	-1.057	significant		-0.799 not significant
Uncertainty of a	0.483			0.488
Expanded measured uncertainty $W_{CM}$	11.78	%		11.90 %

Results for testing the five criteria from chapter 6.1 Method used for equivalence testing were as follows:

- Criterion 1: More than 20% of the data exceed  $28 \mu\text{g}/\text{m}^3$ .
- Criterion 2: Between-AMS uncertainty of the AMS tested did not exceed  $2.5 \mu\text{g}/\text{m}^3$ .
- Criterion 3: Uncertainty between reference instruments did not exceed  $2.0 \mu\text{g}/\text{m}^3$ .
- Criterion 4: All expanded uncertainties remained below 25%.
- Criterion 5: When evaluating the full data set, the slope determined for one instrument is significantly higher than allowed.
- Additional: The slope determined for the full data set regarding both test specimens combined was at 1.027 (cyc.) and 1.029 (per.), the axis intercept was at -0.859 (cyc.) and -0.882 (per) at a total expanded uncertainty of 11.33% (cyc.) and 11.50% (per.).

At -1.041 (cyc.) and 1.057 (per.) for instrument 1, the axis intercept is significantly different from 0. This is why chapter 6.1 17 Use of correction factors/terms contains an additional assessment for which the corresponding calibration factor was applied to the data sets.

It should be noted here that the uncertainty  $W_{\text{CM}}$  determined without applying correction factors for all observed data sets is below the determined expanded relative uncertainty  $W_{\text{dqq}}$  of 25% for  $\text{PM}_{10}$ .

## 6.6 Detailed presentation of test results

Table 24 provides an overview of the between-RM uncertainties  $u_{\text{bs, RM}}$  determined during the field tests.

Table 24: Between RM uncertainty  $u_{\text{bs, RM}}$

Reference instruments	Location	Number of measurements	Uncertainty $u_{\text{bs, RM}}$
No.			$\mu\text{g}/\text{m}^3$
1 / 2	Cologne, Winter	57	0.40
1 / 2	Bonn, Belderberg	40	0.94
1 / 2	Bulk handling, Summer	66	0.60
1 / 2	Bulk handling, Winter	45	0.50
1 / 2	All locations	208	0.62

At all sites, between-RM uncertainty  $u_{\text{bs, RM}}$  was  $< 2.0 \mu\text{g}/\text{m}^3$ .

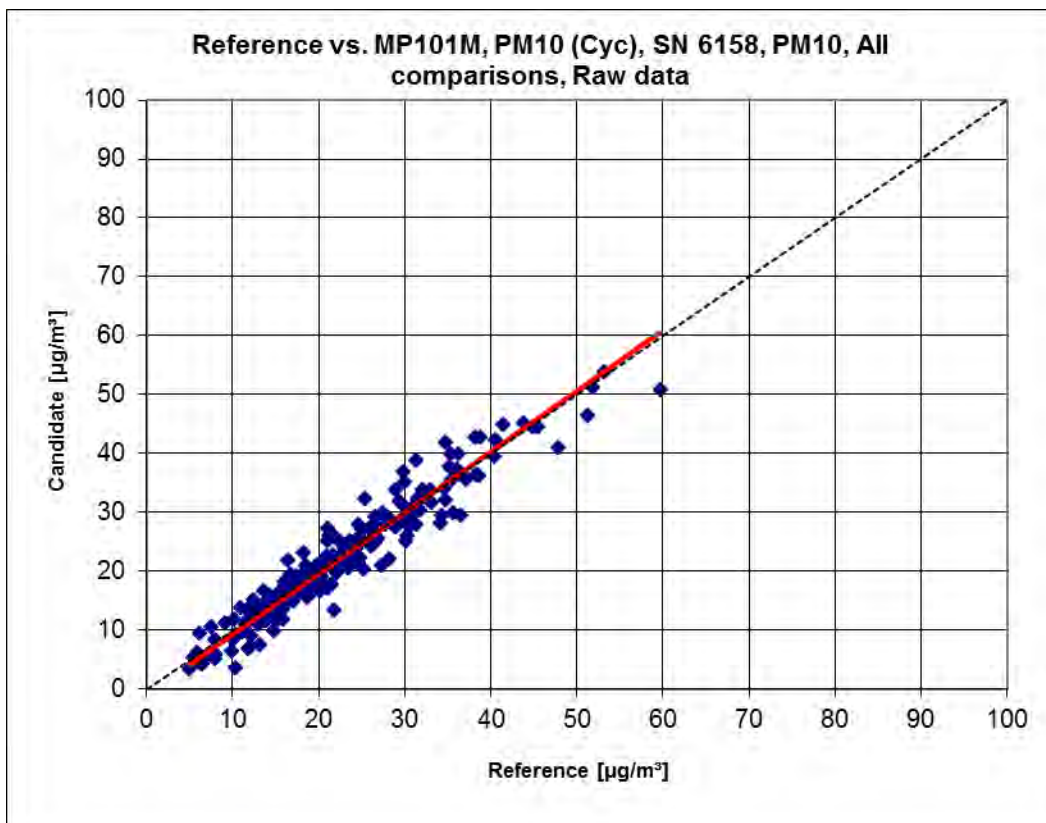


Figure 27: Reference vs. Tested instrument, S/N 6158, all sites, cyc.

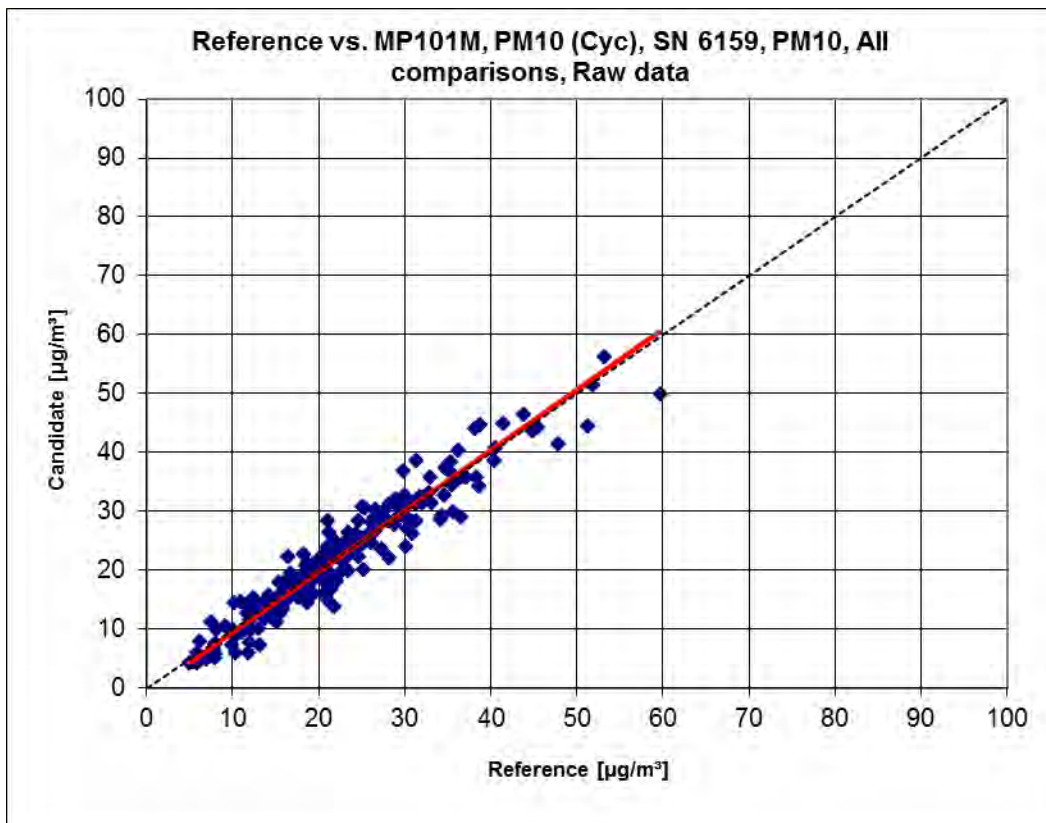


Figure 28: Reference vs. Tested instrument, S/N 6159, all sites, cyc.

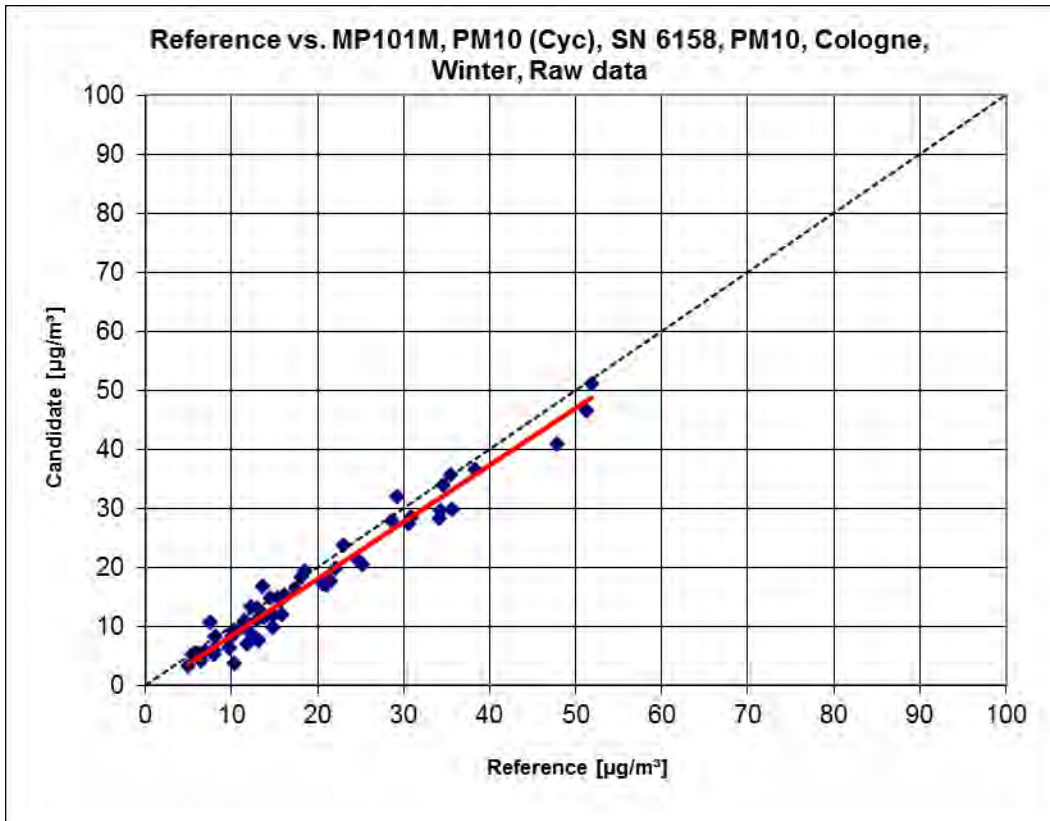


Figure 29: Reference vs. Tested instrument, S/N 6158, Cologne, winter, cyc.

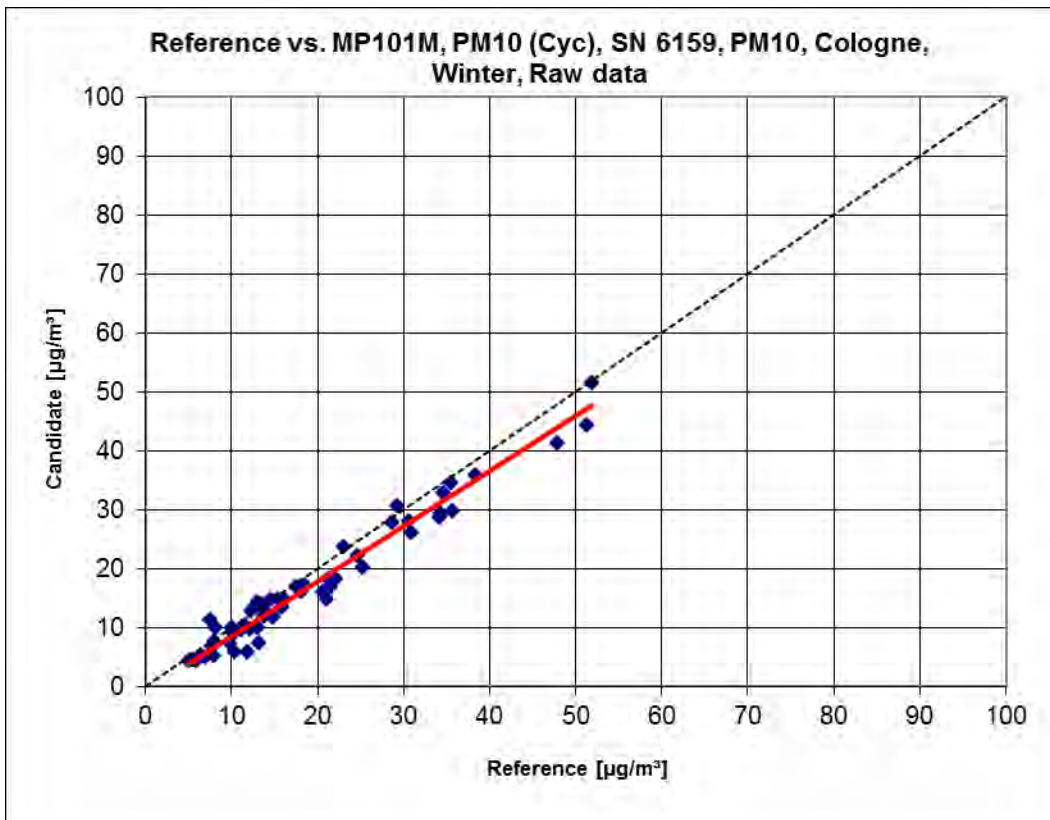


Figure 30: Reference vs. Tested instrument, S/N 6159, Cologne, winter, cyc.



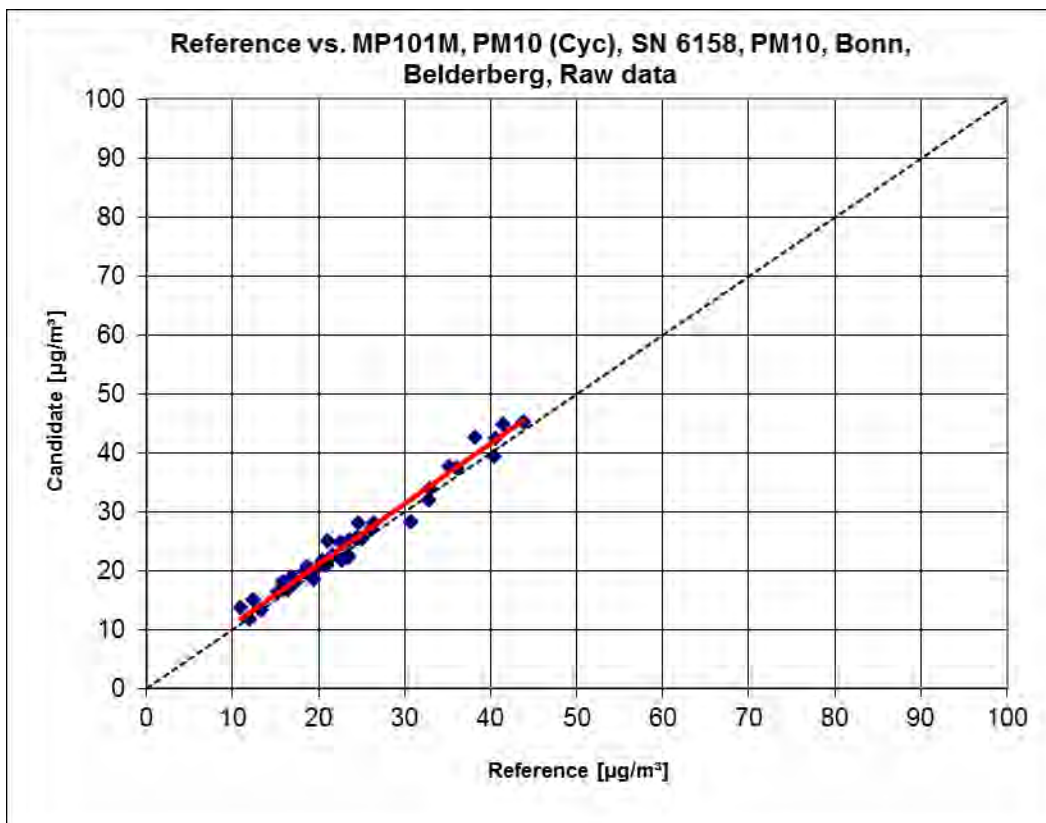


Figure 31: Reference vs. Tested instrument, S/N 6158, Bonn-Belderberg, cyc.

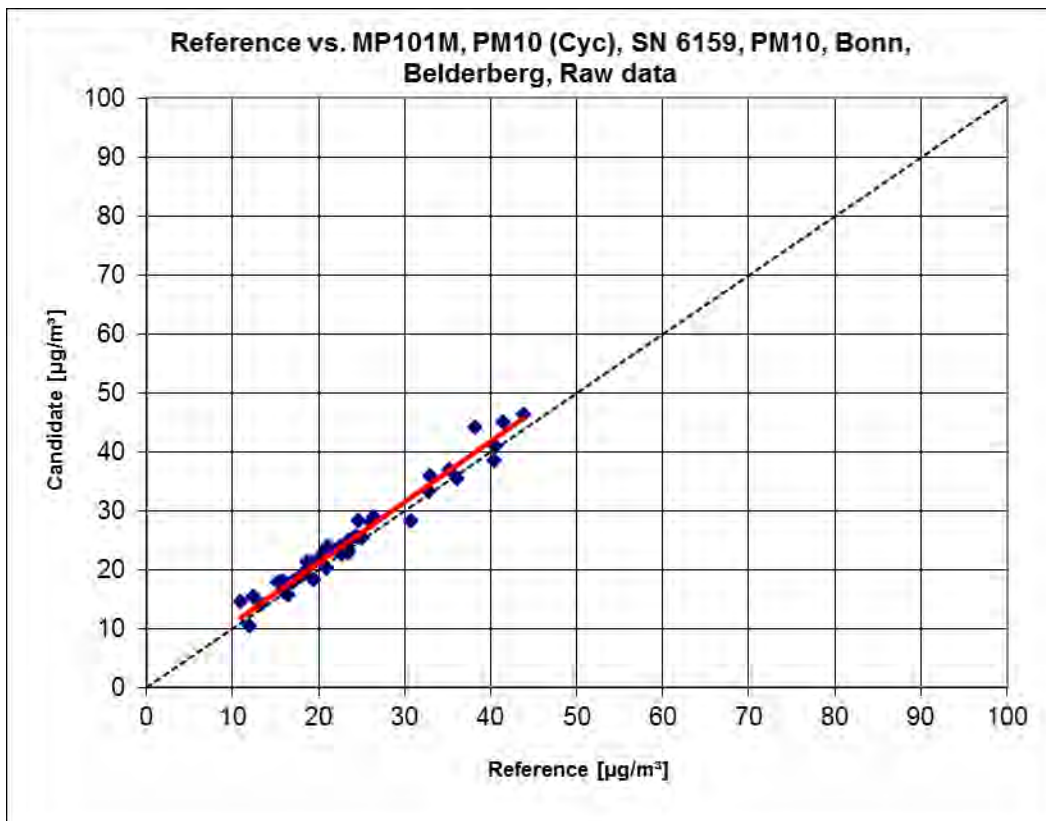


Figure 32: Reference vs. Tested instrument, S/N 6159, Bonn-Belderberg, cyc.



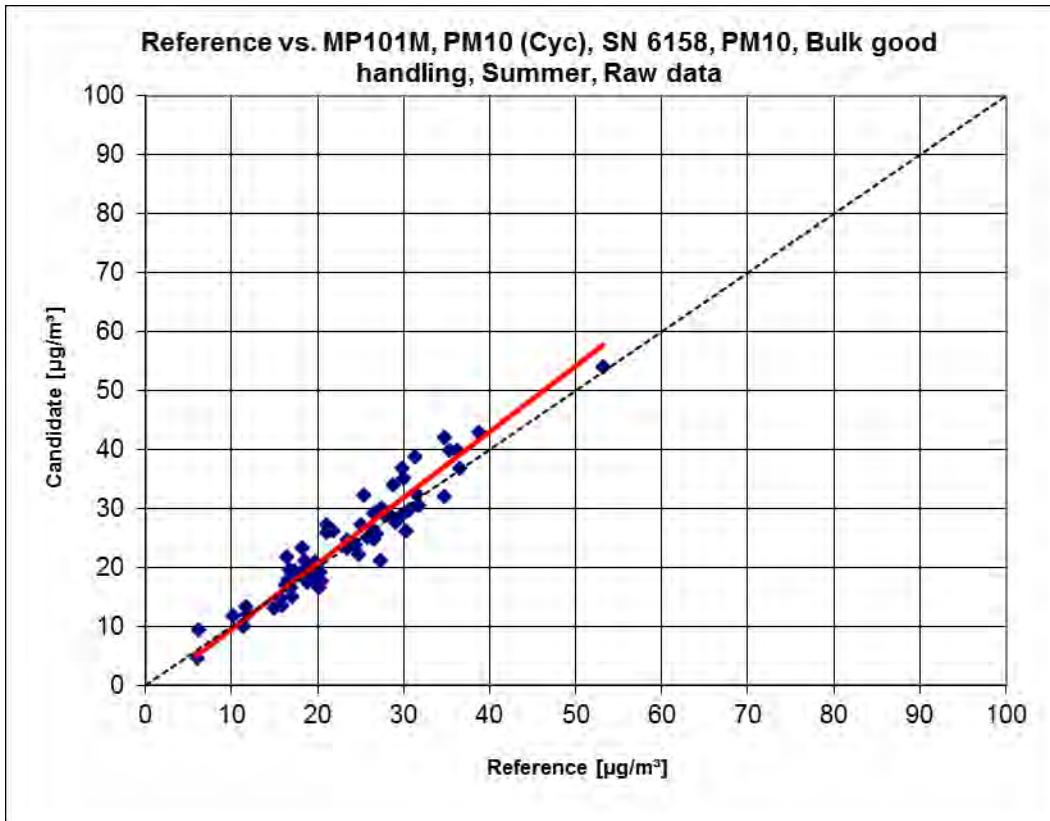


Figure 33: Reference vs. Tested instrument, S/N 6158, bulk handling, summer, cyc.

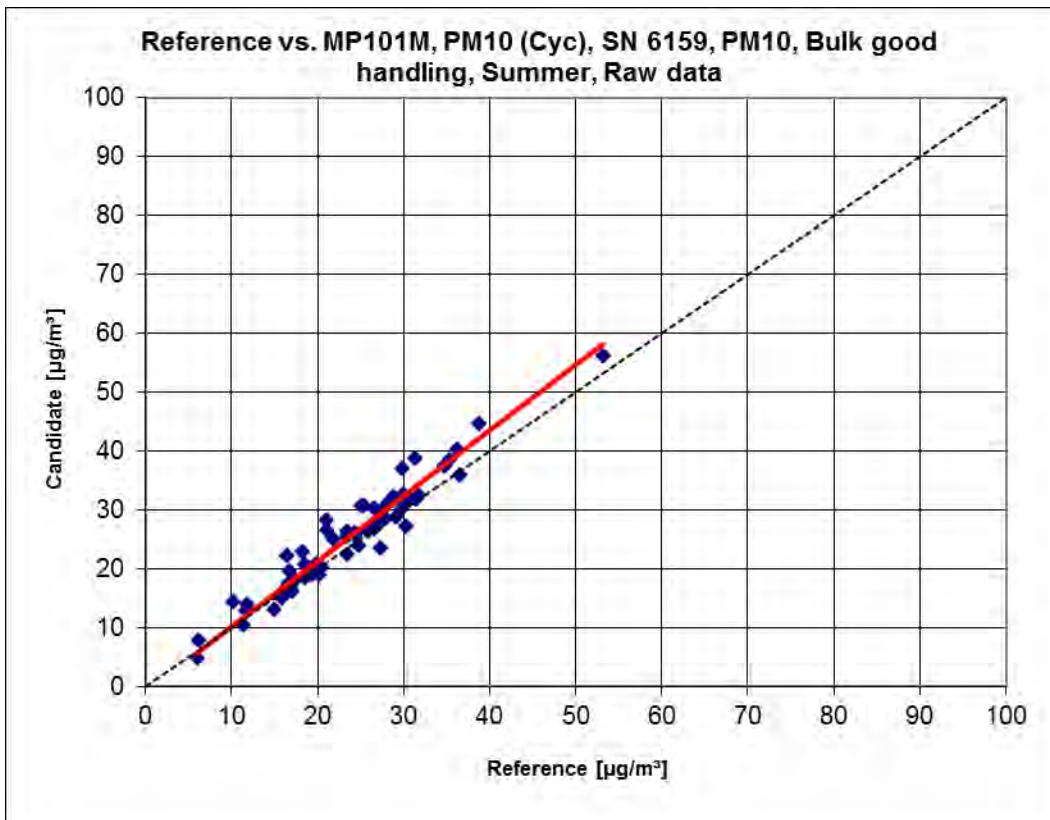


Figure 34: Reference vs. Tested instrument, S/N 6159, bulk handling, summer, cyc.

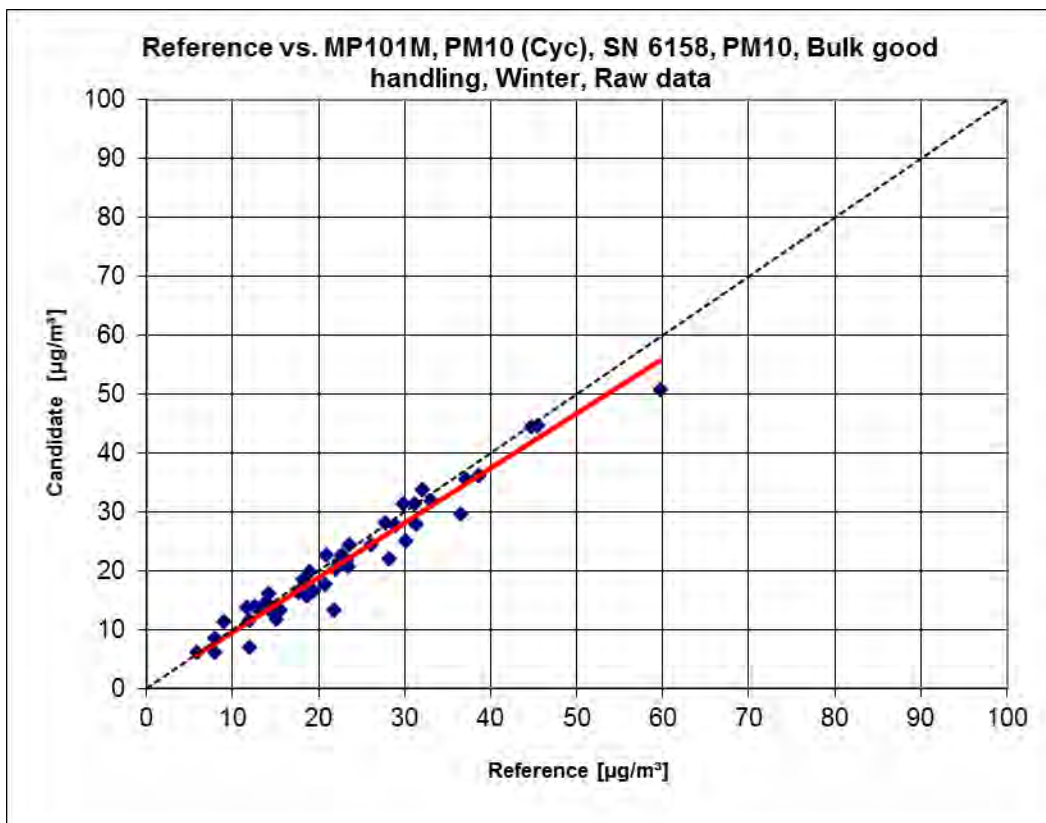


Figure 35: Reference vs. Tested instrument, S/N 6158, bulk handling, winter, cyc.

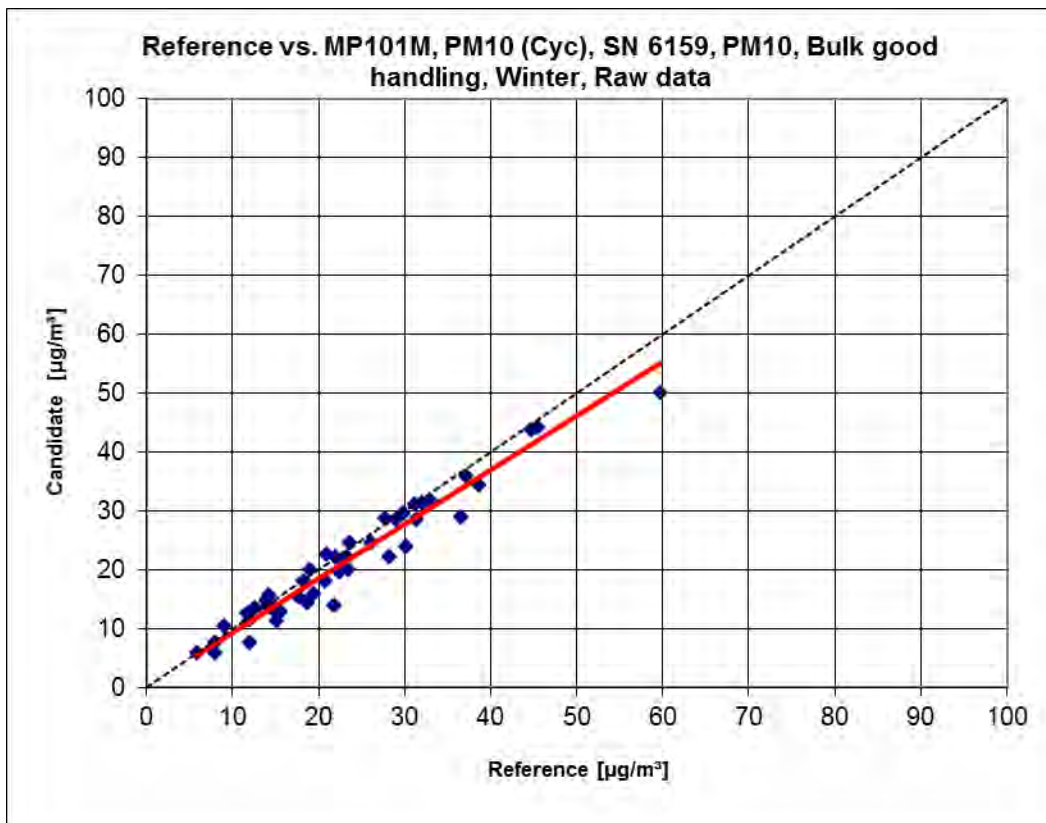


Figure 36: Reference vs. Tested instrument, S/N 6159, bulk handling, winter, cyc.

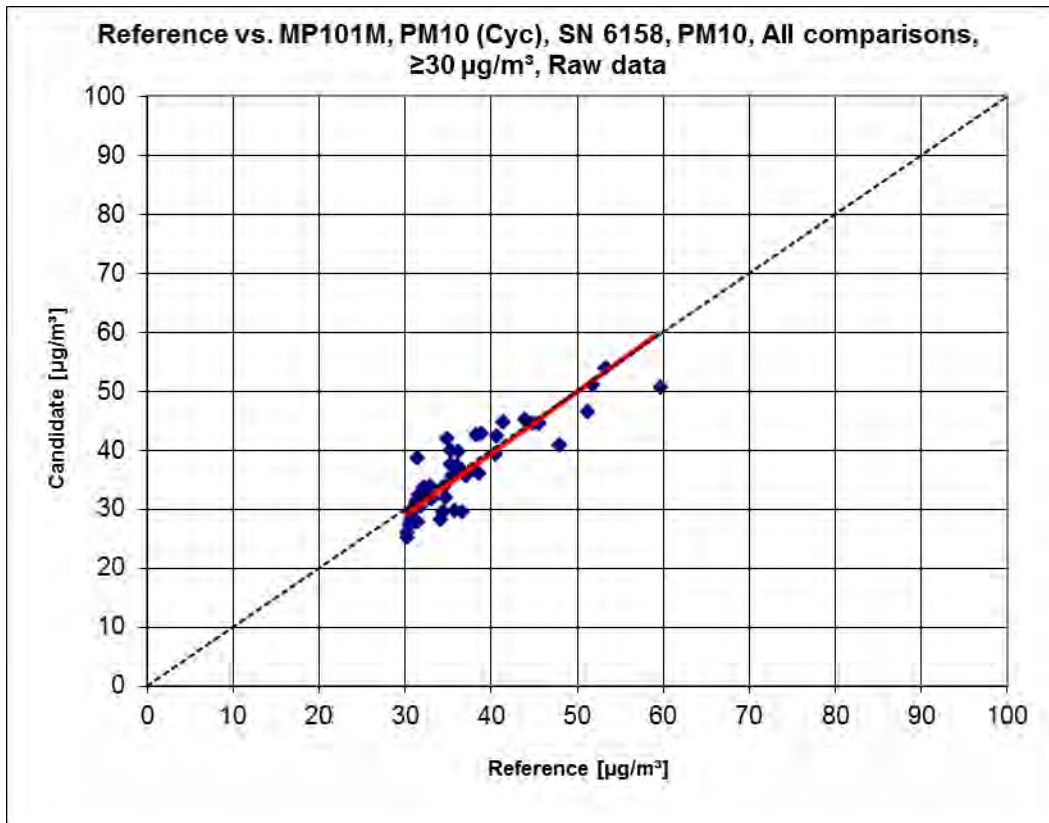


Figure 37: Reference vs. Tested instrument, S/N 6158, values  $\geq 30 \mu\text{g}/\text{m}^3$ , cyc.

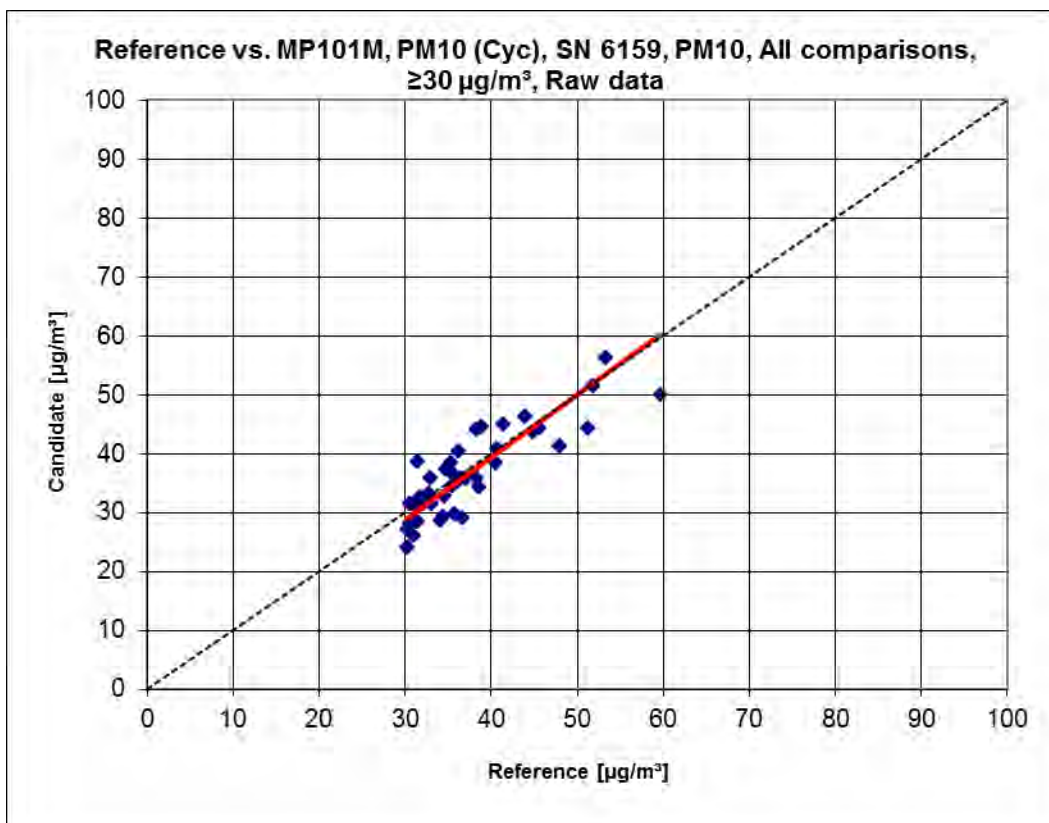


Figure 38: Reference vs. Tested instrument, S/N 6159, values  $\geq 30 \mu\text{g}/\text{m}^3$ , cyc.

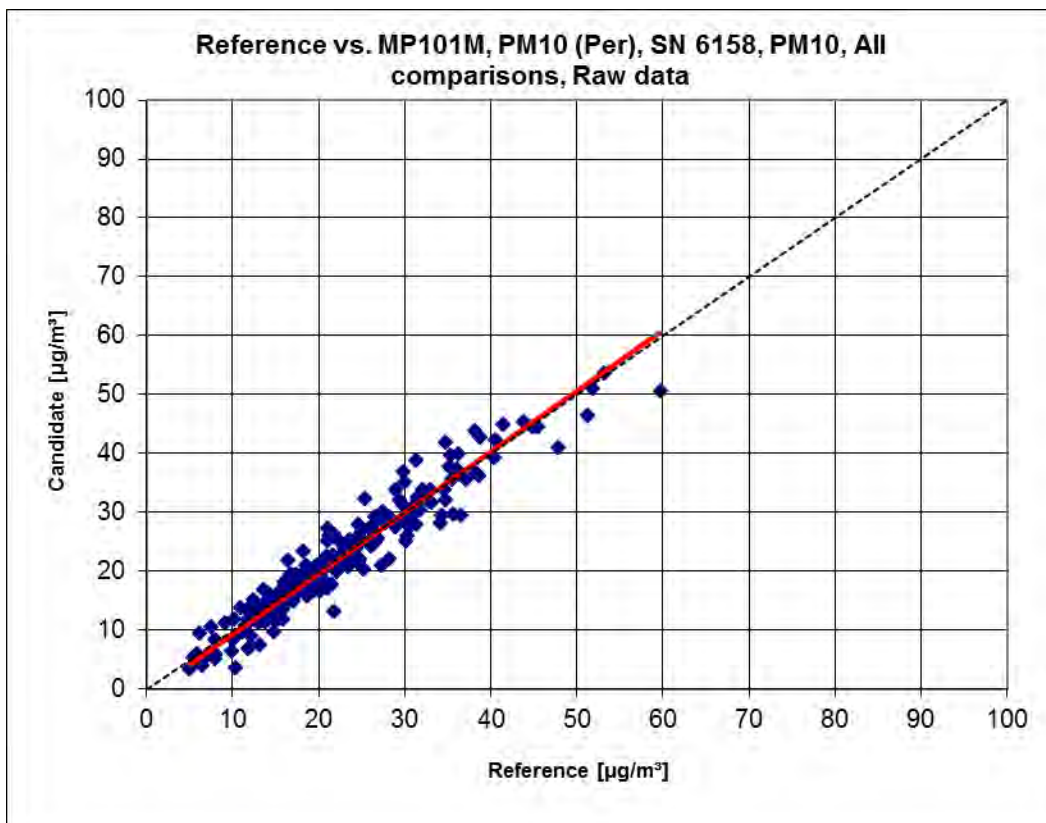


Figure 39: Reference vs. Tested instrument, S/N 6158, all sites, per.

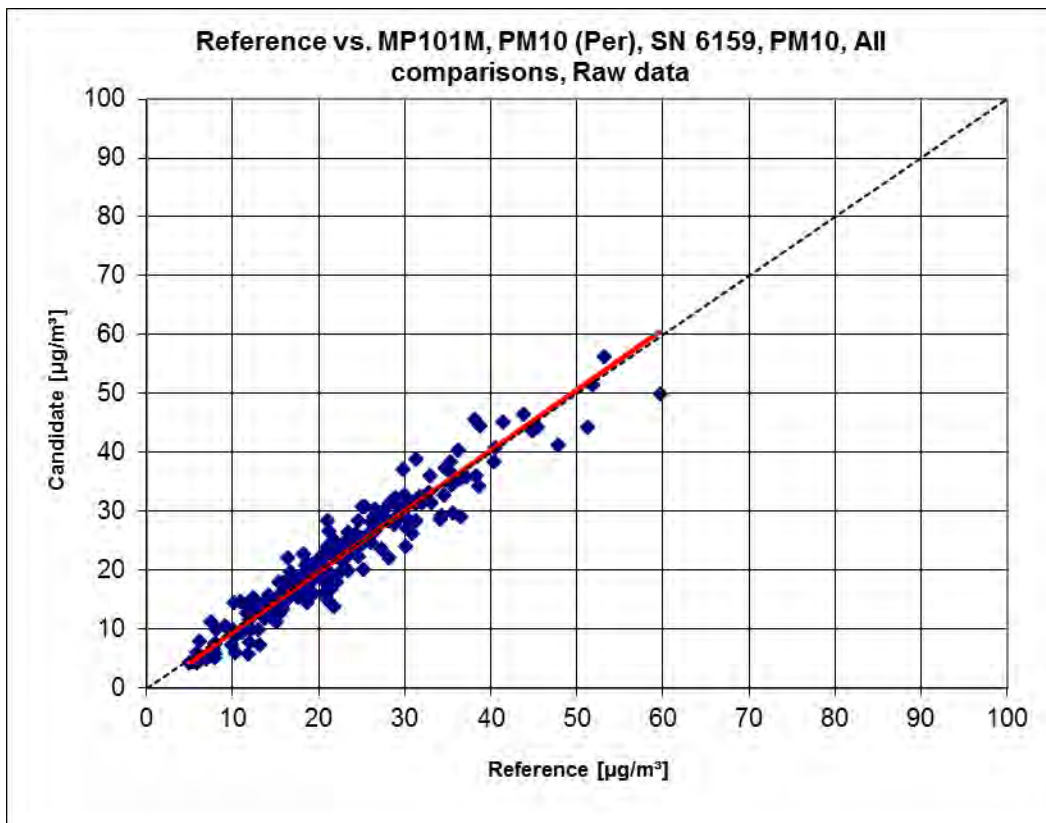


Figure 40: Reference vs. Tested instrument, S/N 6159, all sites, per.



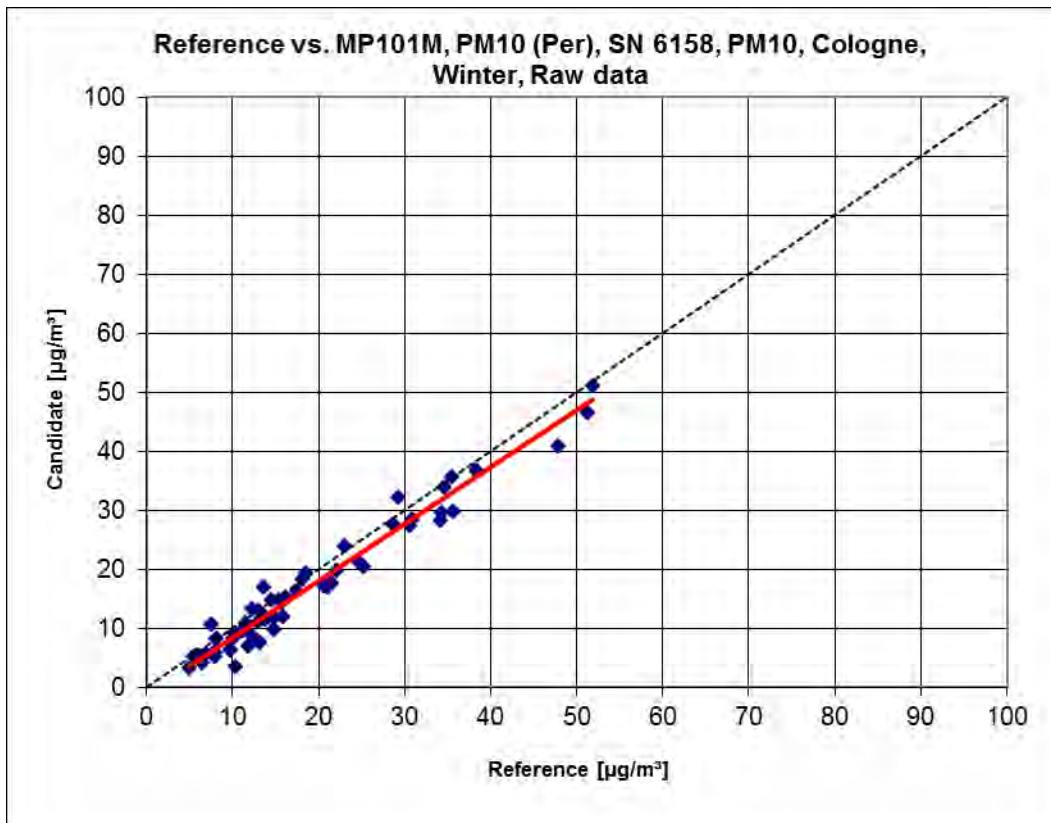


Figure 41: Reference vs. Tested instrument, S/N 6158, Cologne, winter, per.

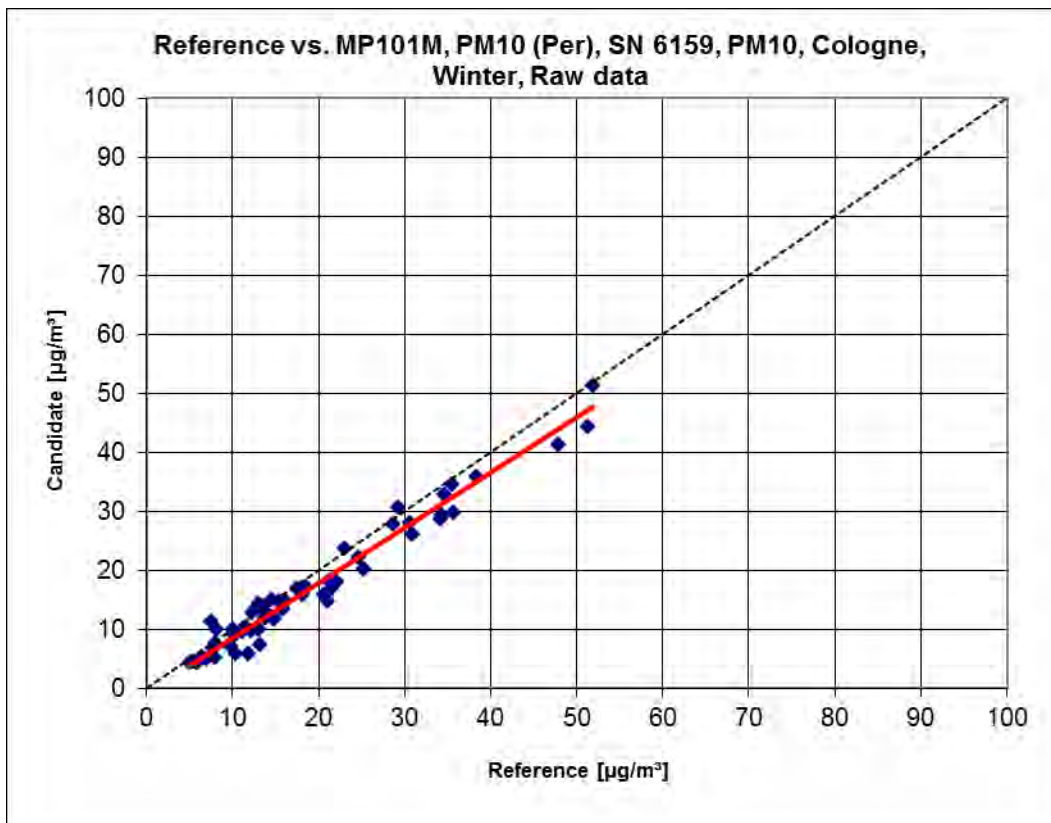


Figure 42: Reference vs. Tested instrument, S/N 6159, Cologne, winter, per.

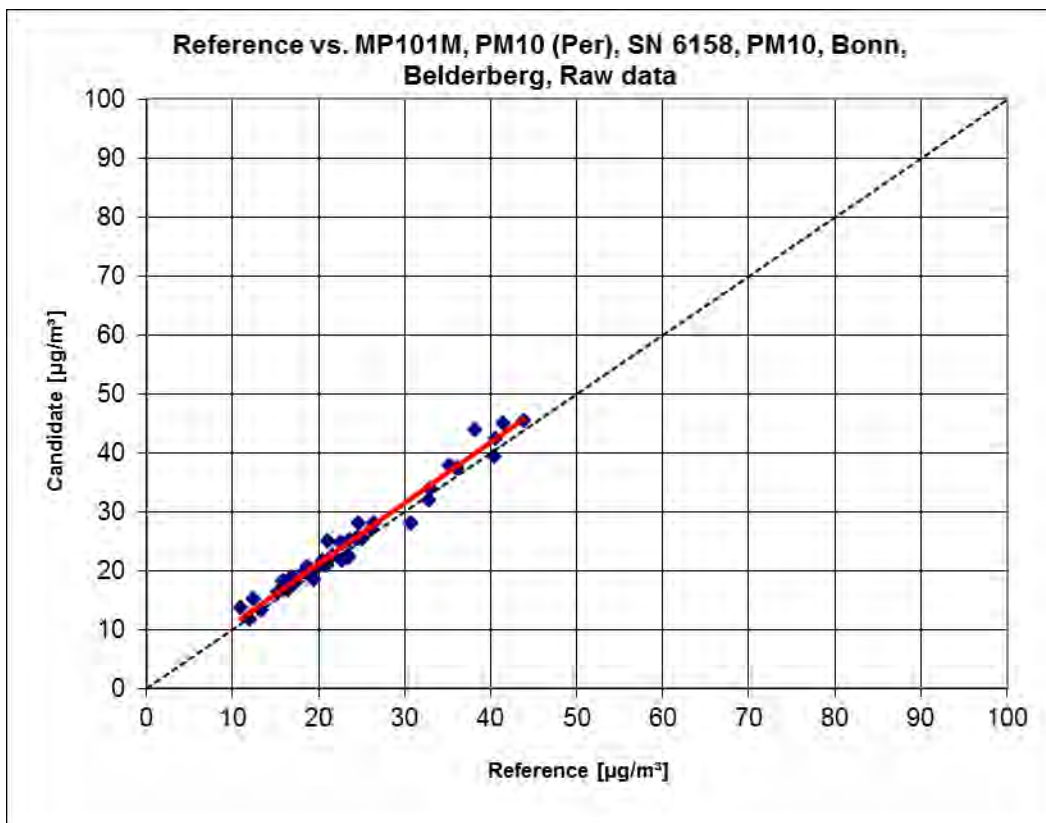


Figure 43: Reference vs. Tested instrument, S/N 6158, Bonn-Belderberg, per.

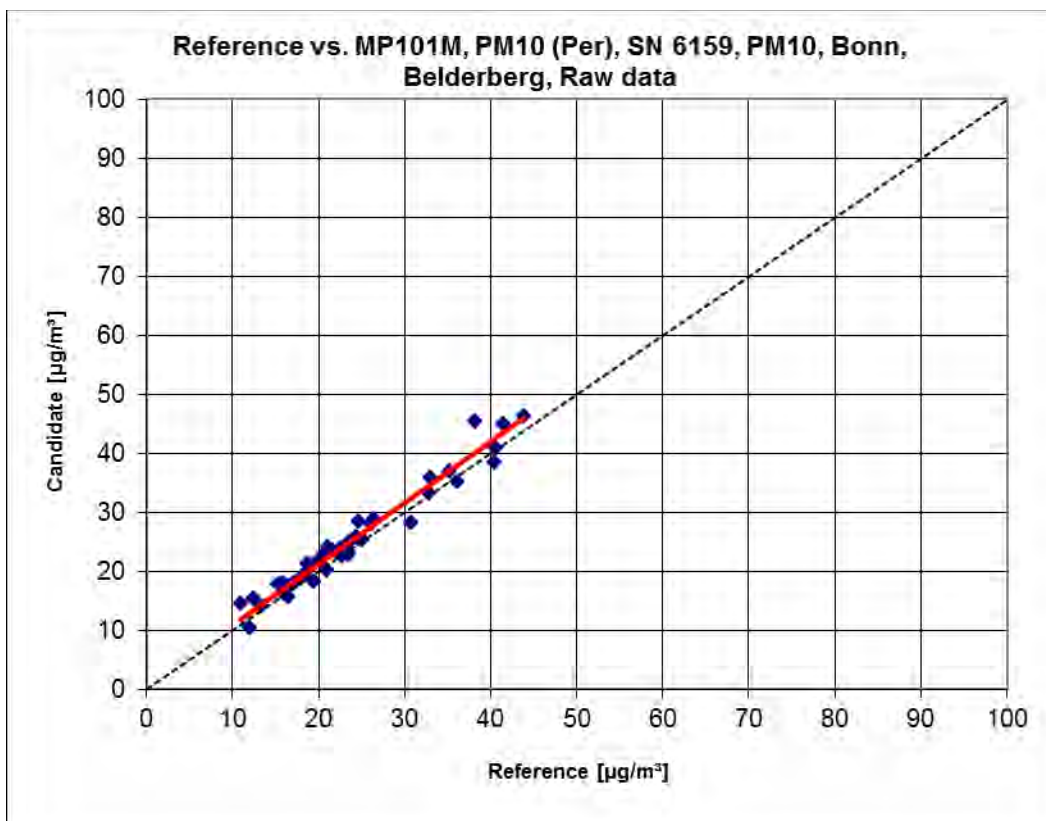


Figure 44: Reference vs. Tested instrument, S/N 6159, Bonn-Belderberg, per.

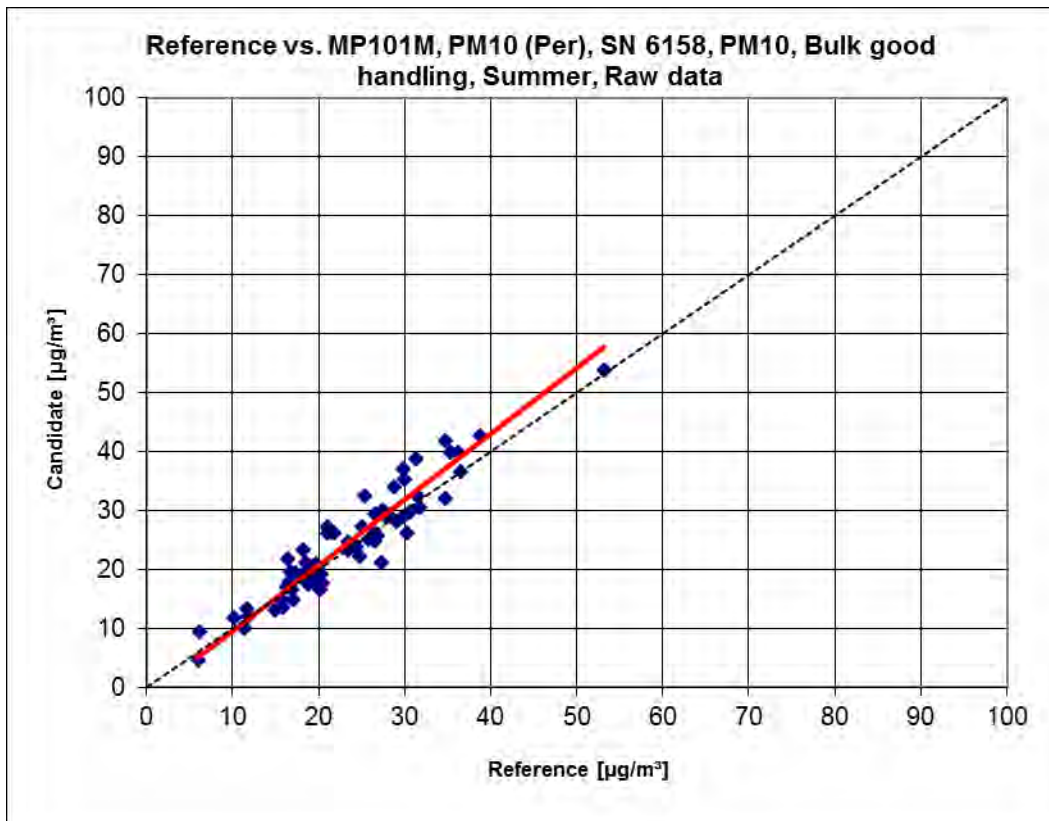


Figure 45: Reference vs. Tested instrument, S/N 6158, bulk handling, summer, per.

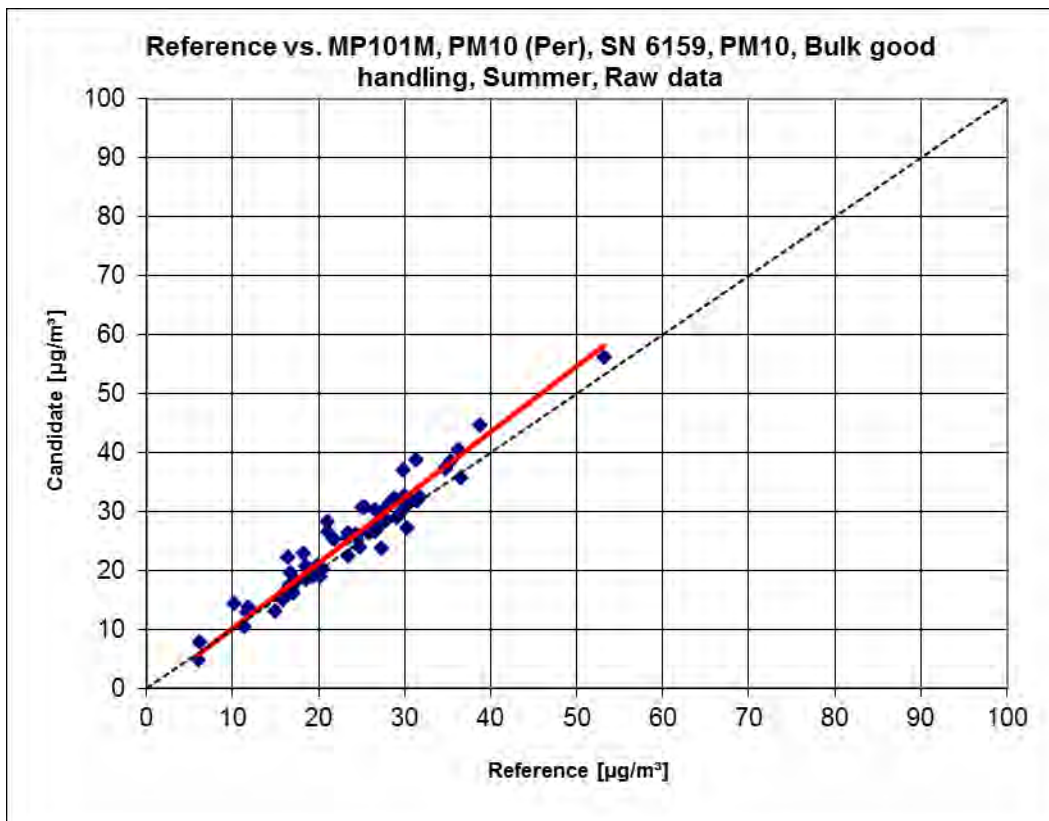


Figure 46: Reference vs. Tested instrument, S/N 6159, bulk handling, summer, per.

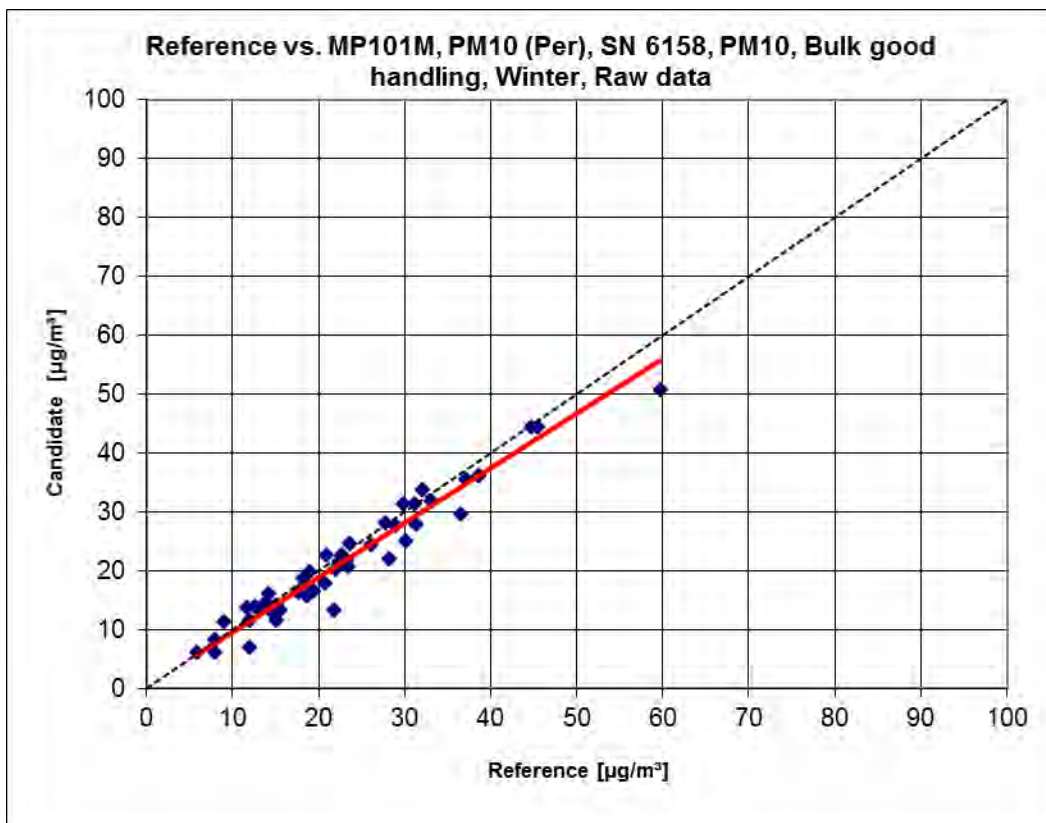


Figure 47: Reference vs. Tested instrument, S/N 6158, bulk handling, winter, per.

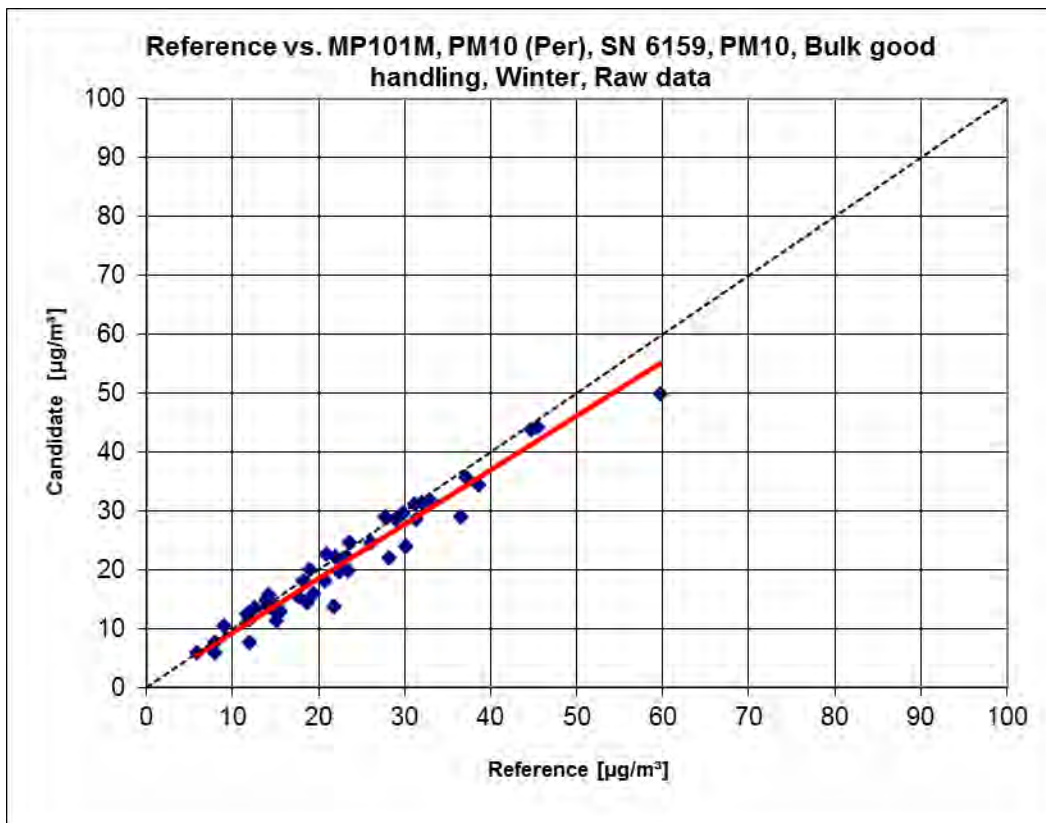


Figure 48: Reference vs. Tested instrument, S/N 6159, bulk handling, winter, per.



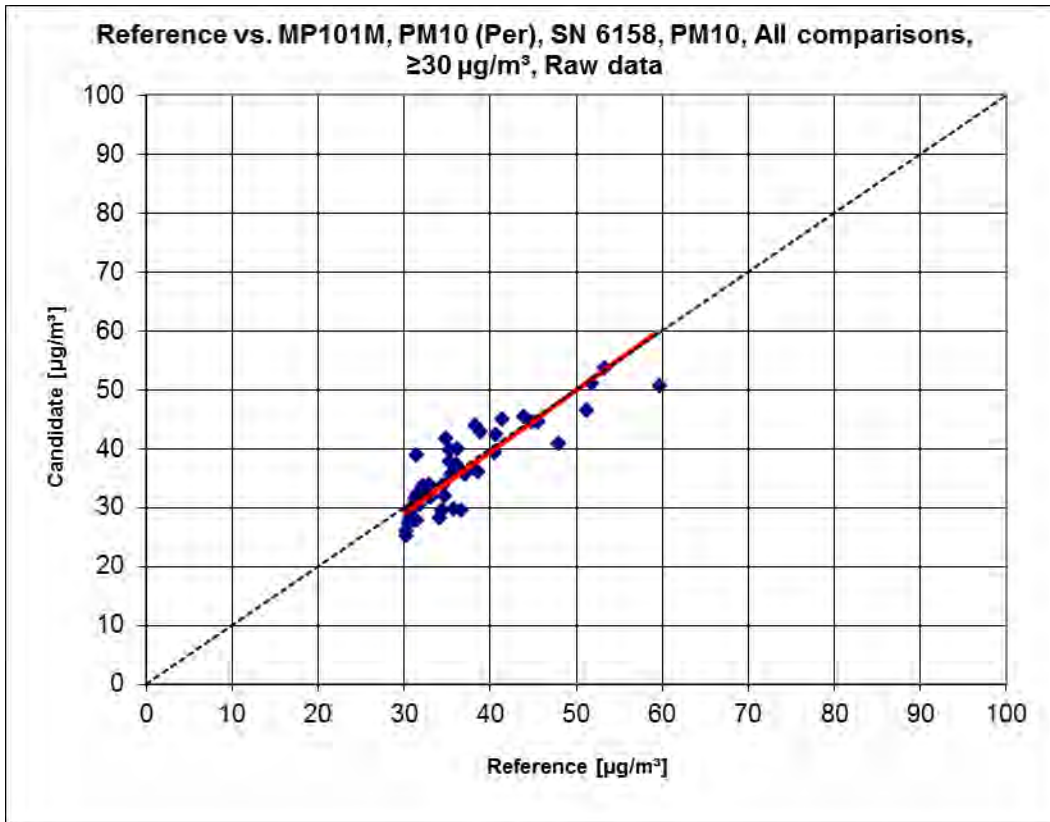


Figure 49: Reference vs. Tested instrument, S/N 6158, values  $\geq 30 \mu\text{g}/\text{m}^3$ , per.

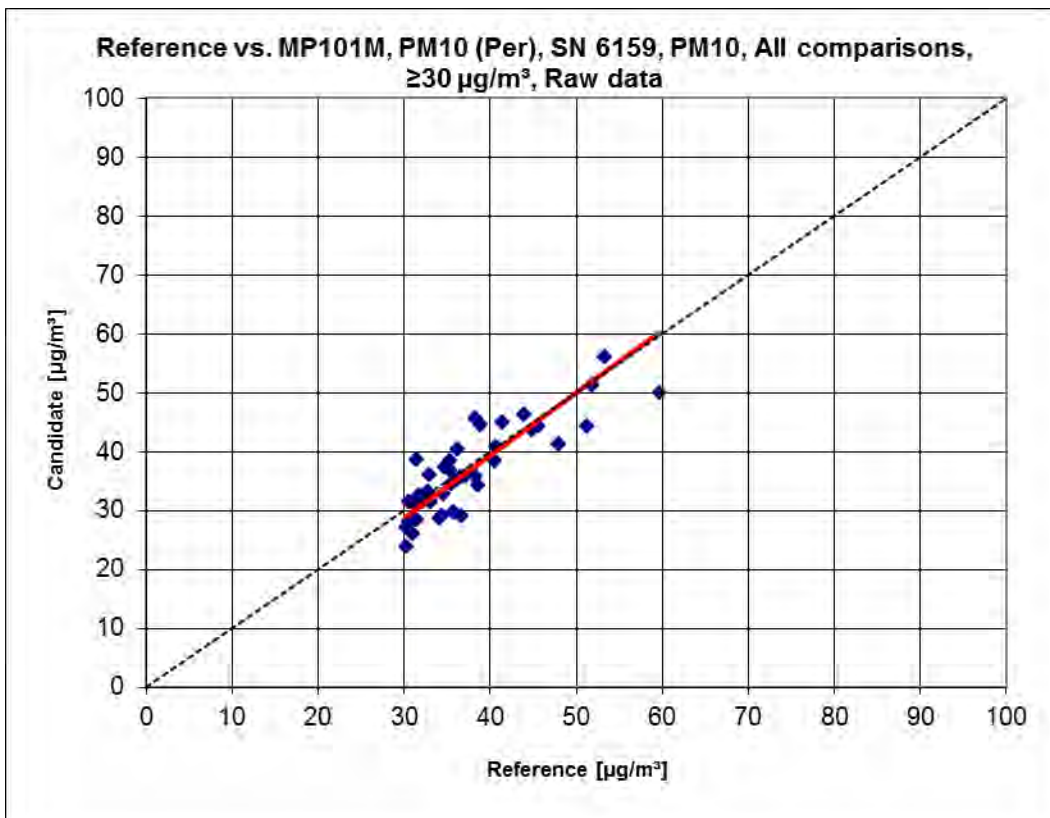


Figure 50: Reference vs. Tested instrument, S/N 6159, values  $\geq 30 \mu\text{g}/\text{m}^3$ , per.

## 6.1 17 Use of correction factors/terms (7.5.8.5–7.5.8.8)

*Correction factors/terms (=calibration) shall be applied if the highest expanded uncertainty calculated for the tested instruments exceeds the relative expanded uncertainty specified under the requirements for data quality or the test demonstrates that the slope is significantly different from 1 and/or the ordinate intercept is significantly different from 0.*

## 6.2 Equipment

Not required for this performance criterion

## 6.3 Testing

See section 6.1 17 Expanded uncertainty (7.5.8.5 – 7.5.8.8).

## 6.4 Evaluation

If it emerges from the evaluation of raw data in accordance with 6.1 17 Expanded uncertainty (7.5.8.5 – 7.5.8.8) that  $W_{AMS} > W_{dqo}$ , (i.e. AMS uncertainty > 25%) i.e. the tested instrument is not found to be equivalent with the reference method, then it is permissible to use a correction factor or term which results from the regression equation for the full data set. The corrected values have to meet the requirements for all data sets or sub data sets. Moreover, a correction may also be used for the case that  $W_{AMS} \leq W_{dqo}$  in order to improve the accuracy of the tested instruments.

Three different situations may occur:

a) Slope b is not significantly different from 1:  $|b - 1| \leq 2u(b)$

Axis intercept a is significantly different from 0:  $|a| > 2u(a)$

b) Slope b is significantly different from 1:  $|b - 1| > 2u(b)$

axis intercept a is not significantly different from 0:  $|a| \leq 2u(a)$

b) Slope b is significantly different from 1:  $|b - 1| > 2u(b)$

Axis intercept a is significantly different from 0:  $|a| > 2u(a)$

concerning a)

The value of the axis intercept a may be used as a correction term to correct all input values  $y_i$  according to the following equation:

$$y_{i,cor} = y_i - a$$

The corrected values  $y_{i,corr}$  may then serve to calculate the following new terms using linear regression:

$$y_{i,corr} = c + dx_i$$

and

$$u_{y_{i,corr}}^2 = \frac{RSS}{(n-2)} - u_{RM}^2 + [c + (d-1)L]^2 + u^2(a)$$

where  $u(a)$  = uncertainty of the axis intercept  $a$ , whose value was used to determine  $y_{i,corr}$ .

The algorithms for calculating axis intercepts and slopes as well as their variance by means of orthogonal regression are described in detail in the annex to [4].

concerning b)

The value of the slope  $b$  may be used as a correction term to correct all input values  $y_i$  according to the following equation:

$$y_{i,corr} = \frac{y_i}{b}$$

The corrected values  $y_{i,corr}$  may then serve to calculate the following new terms using a new linear regression:

$$y_{i,corr} = c + dx_i$$

and

$$u_{y_{i,corr}}^2 = \frac{RSS}{(n-2)} - u_{RM}^2 + [c + (d-1)L]^2 + L^2 u^2(b)$$

where  $u(b)$  = uncertainty of the original slope  $b$ , whose value was used to determine  $y_{i,corr}$ .

The algorithms for calculating axis intercepts and slopes as well as their variance by means of orthogonal regression are described in detail in the annex to [9].

concerning c)

The values of the slope  $b$  and the axis intercept  $a$  may be used as a correction terms to correct all input values  $y_i$  according to the following equation:

$$y_{i,corr} = \frac{y_i - a}{b}$$

The corrected values  $y_{i,corr}$  may then serve to calculate the following new terms using a new linear regression:

$$y_{i,corr} = c + dx_i$$

and

$$u_{y_i,corr}^2 = \frac{RSS}{(n-2)} - u_{RM}^2 + [c + (d-1)L]^2 + L^2 u^2(b) + u^2(a)$$

where  $u(b)$  = uncertainty of the original slope  $b$ , whose value was used to determine  $y_{i,corr}$  and  $u(a)$  = uncertainty of the original axis intercept  $a$ , whose value was used to determine  $y_{i,corr}$ .

The algorithms for calculating axis intercepts and slopes as well as their variance by means of orthogonal regression are described in detail in the annex to [4].

The values for  $u_{c,s,corr}$  are then used to calculate the combined relative uncertainty of the AMS after correction in accordance with the following equation:

$$W_{AMS,corr}^2 = \frac{u_{corr,y_i=L}^2}{L^2}$$

The uncertainty  $w_{AMS,corr}$  for the corrected data set is calculated at the 24h limit value using  $y_i$  as concentration at the limit value.

The relative expanded uncertainty  $W_{AMS,corr}$  is calculated using the following equation:

$$W_{AMS',corr} = k \cdot w_{AMS,corr}$$

Considering the large number of available test results, an expansion factor  $k=2$  must be used.

The largest resulting uncertainty  $W_{AMS,corr}$  is compared and assessed against the criteria for data quality of air quality measurements in accordance with EU Directive [8]. Two situations are conceivable:

1.  $W_{AMS,corr} \leq W_{dqo}$  → The tested instrument is deemed equivalent to the reference method.
2.  $W_{AMS,corr} > W_{dqo}$  → The tested instrument is not deemed equivalent to the reference method.

The expanded relative uncertainty  $W_{dqo}$  specified is 25%.

## 6.5 Assessment

After the use of correction factors, the candidate systems met the requirements for data quality of air quality monitors for all data sets. The requirements had been met even before a correction factor was applied.

Criterion satisfied? yes

In evaluating the full dataset, it emerged that the axis intercept determined for instrument 1 is significantly different from 0.

At -1.041 (cyc.) and 1.057 (per.) for instrument 1, the axis intercept is significantly different from 0. At -0.859 (cyc.) and -0.882, the axis intercept determined for the full dataset does not differ significantly from 0.

The full data set was corrected in terms of the intercept. All data sets were re-evaluated using the corrected values.

## Dependence of the reading on the ambient temperature

When a measuring system is operated in the context of a measurement grid, the January 2010 version of the Guideline and standard EN 16450 require that the instruments are tested annually at a number of sites which in turn depends on the highest's expanded uncertainty determined during equivalence testing. The criterion used for specifying the number of sites for annual testing is grouped into 5% steps (Guideline [9], Chapter 9.9.2, Table 6 and/or EN 16450 [4], Chapter 8.6.2, Table 5). It should be noted that the highest expanded uncertainty determined after applying the correction was in the range 20% to 25%.

The operator of the measurement grid or the competent authority of a member state is responsible for compliant implementation of the requirements for regular tests as described above. TÜV Rheinland recommend, however, to consider the expanded uncertainty of the full dataset, in this instance 11.33% (cyc.) and 11.50% (per.) (uncorrected) as well as 12.56% (cyc.) and 12.82% (Per.) (dataset after correction of the axis intercept), which would imply annual verification at three measurement sites.

## 6.6 Detailed presentation of test results

Table 25 and Table 26 show the evaluation results of the equivalence test after applying the correction factor to the full data set.

Table 25: Summary of equivalence test results after intercept correction (cyc)

Comparison candidate with reference according to Standard EN 16450:2017				
Candidate	MP101M, PM10 (Cyc)	SN	SN 6158 & SN 6159	
Status of measured values	Raw data	Limit value	50	µg/m <sup>3</sup>
		Allowed uncertainty	25	%
<b>All comparisons</b>				
Uncertainty between Reference	0.62			µg/m <sup>3</sup>
Uncertainty between Candidates	0.94			µg/m <sup>3</sup>
<b>SN 6158 &amp; SN 6159</b>				
Number of data pairs	208			
Slope b	1.027			not significant
Uncertainty of b	0.019			
Ordinate intercept a	0.000			not significant
Uncertainty of a	0.468			
Expanded measured uncertainty WCM	12.56			%
<b>All comparisons, ≥30 µg/m<sup>3</sup></b>				
Uncertainty between Reference	0.81			µg/m <sup>3</sup>
Uncertainty between Candidates	1.13			µg/m <sup>3</sup>
<b>SN 6158 &amp; SN 6159</b>				
Number of data pairs	44			
Slope b	1.043			
Uncertainty of b	0.080			
Ordinate intercept a	-1.534			
Uncertainty of a	3.018			
Expanded measured uncertainty WCM	15.18			%

Comparison candidate with reference according to Standard EN 16450:2017				
Candidate	MP101M, PM10 (Cyc)		SN	SN 6158 & SN 6159
Status of measured values	Raw data		Limit value	50 $\mu\text{g}/\text{m}^3$
			Allowed uncertainty	25 %
<b>Cologne, Winter</b>				
Uncertainty between Reference	0.40		$\mu\text{g}/\text{m}^3$	
Uncertainty between Candidates	0.86		$\mu\text{g}/\text{m}^3$	
	<b>SN 6158</b>		<b>SN 6159</b>	
Number of data pairs	57			57
Slope b	0.967			0.936
Uncertainty of b	0.026			0.024
Ordinate intercept a	-0.507			-0.003
Uncertainty of a	0.572			0.533
Expanded measured uncertainty $W_{CM}$	12.47	%		15.39 %
<b>Bonn, Belderberg</b>				
Uncertainty between Reference	0.94		$\mu\text{g}/\text{m}^3$	
Uncertainty between Candidates	0.77		$\mu\text{g}/\text{m}^3$	
	<b>SN 6158</b>		<b>SN 6159</b>	
Number of data pairs	40			40
Slope b	1.026			1.028
Uncertainty of b	0.027			0.032
Ordinate intercept a	1.385			1.501
Uncertainty of a	0.703			0.808
Expanded measured uncertainty $W_{CM}$	12.13	%		13.38 %
<b>Bulk good handling, Summer</b>				
Uncertainty between Reference	0.60		$\mu\text{g}/\text{m}^3$	
Uncertainty between Candidates	1.21		$\mu\text{g}/\text{m}^3$	
	<b>SN 6158</b>		<b>SN 6159</b>	
Number of data pairs	66			66
Slope b	1.116			1.109
Uncertainty of b	0.045			0.036
Ordinate intercept a	-0.888			-0.083
Uncertainty of a	1.111			0.888
Expanded measured uncertainty $W_{CM}$	23.09	%		23.57 %
<b>Bulk good handling, Winter</b>				
Uncertainty between Reference	0.50		$\mu\text{g}/\text{m}^3$	
Uncertainty between Candidates	0.65		$\mu\text{g}/\text{m}^3$	
	<b>SN 6158</b>		<b>SN 6159</b>	
Number of data pairs	45			45
Slope b	0.931			0.919
Uncertainty of b	0.033			0.033
Ordinate intercept a	1.033			1.004
Uncertainty of a	0.852			0.834
Expanded measured uncertainty $W_{CM}$	13.92	%		15.61 %
<b>All comparisons, <math>\geq 30 \mu\text{g}/\text{m}^3</math></b>				
Uncertainty between Reference	0.81		$\mu\text{g}/\text{m}^3$	
Uncertainty between Candidates	1.13		$\mu\text{g}/\text{m}^3$	
	<b>SN 6158</b>		<b>SN 6159</b>	
Number of data pairs	44			44
Slope b	1.046			1.056
Uncertainty of b	0.080			0.083
Ordinate intercept a	-1.585			-2.067
Uncertainty of a	3.019			3.17
Expanded measured uncertainty $W_{CM}$	15.25	%		16.06 %
<b>All comparisons</b>				
Uncertainty between Reference	0.62		$\mu\text{g}/\text{m}^3$	
Uncertainty between Candidates	0.94		$\mu\text{g}/\text{m}^3$	
	<b>SN 6158</b>		<b>SN 6159</b>	
Number of data pairs	208			208
Slope b	1.032	not significant		1.027 not significant
Uncertainty of b	0.020			0.020
Ordinate intercept a	-0.182	not significant		0.092 not significant
Uncertainty of a	0.478			0.482
Expanded measured uncertainty $W_{CM}$	12.89	%		12.95 %

Table 26: Summary of equivalence test results after intercept correction (per)

Comparison candidate with reference according to Standard EN 16450:2017			
Candidate	MP101M, PM10 (Per)	SN	SN 6158 & SN 6159
Status of measured values	Raw data	Limit value	50 $\mu\text{g}/\text{m}^3$
		Allowed uncertainty	25 %
<b>All comparisons</b>			
Uncertainty between Reference	0.62		$\mu\text{g}/\text{m}^3$
Uncertainty between Candidates	0.95		$\mu\text{g}/\text{m}^3$
<b>SN 6158 &amp; SN 6159</b>			
Number of data pairs	208		
Slope b	1.029		not significant
Uncertainty of b	0.019		
Ordinate intercept a	0.000		not significant
Uncertainty of a	0.474		
Expanded measured uncertainty WCM	12.82		%
<b>All comparisons, <math>\geq 30 \mu\text{g}/\text{m}^3</math></b>			
Uncertainty between Reference	0.81		$\mu\text{g}/\text{m}^3$
Uncertainty between Candidates	1.14		$\mu\text{g}/\text{m}^3$
<b>SN 6158 &amp; SN 6159</b>			
Number of data pairs	44		
Slope b	1.047		
Uncertainty of b	0.081		
Ordinate intercept a	-1.649		
Uncertainty of a	3.077		
Expanded measured uncertainty WCM	15.56		%

Comparison candidate with reference according to Standard EN 16450:2017				
Candidate	MP101M, PM10 (Per)		SN	SN 6158 & SN 6159
Status of measured values	Raw data		Limit value	50 $\mu\text{g}/\text{m}^3$
			Allowed uncertainty	25 %
<b>Cologne, Winter</b>				
Uncertainty between Reference	0.40		$\mu\text{g}/\text{m}^3$	
Uncertainty between Candidates	0.89		$\mu\text{g}/\text{m}^3$	
	<b>SN 6158</b>		<b>SN 6159</b>	
Number of data pairs	57			57
Slope b	0.968			0.936
Uncertainty of b	0.026			0.024
Ordinate intercept a	-0.495			0.013
Uncertainty of a	0.577			0.538
Expanded measured uncertainty $W_{CM}$	12.47	%		15.42 %
<b>Bonn, Belderberg</b>				
Uncertainty between Reference	0.94		$\mu\text{g}/\text{m}^3$	
Uncertainty between Candidates	0.78		$\mu\text{g}/\text{m}^3$	
	<b>SN 6158</b>		<b>SN 6159</b>	
Number of data pairs	40			40
Slope b	1.033			1.039
Uncertainty of b	0.029			0.034
Ordinate intercept a	1.271			1.302
Uncertainty of a	0.753			0.876
Expanded measured uncertainty $W_{CM}$	13.26	%		14.87 %
<b>Bulk good handling, Sommer</b>				
Uncertainty between Reference	0.60		$\mu\text{g}/\text{m}^3$	
Uncertainty between Candidates	1.20		$\mu\text{g}/\text{m}^3$	
	<b>SN 6158</b>		<b>SN 6159</b>	
Number of data pairs	66			66
Slope b	1.116			1.109
Uncertainty of b	0.045			0.036
Ordinate intercept a	-0.839			-0.052
Uncertainty of a	1.116			0.894
Expanded measured uncertainty $W_{CM}$	23.21	%		23.71 %
<b>Bulk good handling, Winter</b>				
Uncertainty between Reference	0.50		$\mu\text{g}/\text{m}^3$	
Uncertainty between Candidates	0.67		$\mu\text{g}/\text{m}^3$	
	<b>SN 6158</b>		<b>SN 6159</b>	
Number of data pairs	45			45
Slope b	0.930			0.918
Uncertainty of b	0.034			0.033
Ordinate intercept a	1.090			1.046
Uncertainty of a	0.858			0.841
Expanded measured uncertainty $W_{CM}$	13.96	%		15.66 %
<b>All comparisons, <math>\geq 30 \mu\text{g}/\text{m}^3</math></b>				
Uncertainty between Reference	0.81		$\mu\text{g}/\text{m}^3$	
Uncertainty between Candidates	1.14		$\mu\text{g}/\text{m}^3$	
	<b>SN 6158</b>		<b>SN 6159</b>	
Number of data pairs	44			44
Slope b	1.048			1.062
Uncertainty of b	0.081			0.085
Ordinate intercept a	-1.653			-2.244
Uncertainty of a	3.064			3.24
Expanded measured uncertainty $W_{CM}$	15.54	%		16.53 %
<b>All comparisons</b>				
Uncertainty between Reference	0.62		$\mu\text{g}/\text{m}^3$	
Uncertainty between Candidates	0.95		$\mu\text{g}/\text{m}^3$	
	<b>SN 6158</b>		<b>SN 6159</b>	
Number of data pairs	208			208
Slope b	1.034	not significant		1.028 not significant
Uncertainty of b	0.020			0.020
Ordinate intercept a	-0.175	not significant		0.082 not significant
Uncertainty of a	0.483			0.488
Expanded measured uncertainty $W_{CM}$	13.14	%		13.23 %



## **6.1 18 Maintenance interval (7.5.7)**

*The maintenance interval of the AMS shall be at least 14 days.*

## **6.2 Equipment**

Not required for this performance criterion

## **6.3 Testing**

The maintenance interval is the longest time period without intervention as recommended by the manufacturer. The competent body shall ensure that during this period the AMS does not need any maintenance or adjustment.

## **6.4 Evaluation**

The manufacturer has prepared a maintenance plan for this measuring system. The shortest maintenance interval is at 1 month (cleaning of the sample inlet).

## **6.5 Assessment**

The maintenance interval is 1 month.

Criterion satisfied? yes

## **6.6 Detailed presentation of test results**

Chapter 4.2 of the manual lists the necessary maintenance work.

## **6.1 19 Automatic diagnostic check (7.5.4)**

*Automatic checks must be possible.*

## **6.2 Equipment**

Not required for this performance criterion

## **6.3 Testing**

The current operating status of the measuring system is continuously monitored and any issues will be flagged via a series of different error messages. The current state of monitored parameters can be displayed on the instrument itself and is recorded as part of data logging. An error message is flagged if performance characteristics are outside the permissible range of tolerance.

## **6.4 Evaluation**

The instrument provides all features described in the operation manual. The current operating status is continuously monitored and any issues will be flagged via a series of different warning messages. Data recording includes all monitored parameters.

## **6.5 Assessment**

The instrument provides all features described in the operation manual. The current operating status is continuously monitored and any issues will be flagged via a series of different warning messages. Data recording includes all monitored parameters.

Criterion satisfied? yes

## **6.6 Detailed presentation of test results**

Chapter 5 of the operation manual describes all possible alarms and status codes.

## 6.1 20 Checks of temperature sensors, pressure and/or humidity sensors

*The verifiability of temperature sensors, pressure and/or humidity sensors shall be checked for the AMS. Deviations determined shall be within the following criteria:*

$T \pm 2 \text{ }^\circ\text{C}$

$p \pm 1 \text{ kPa}$

$rF \pm 5 \%$

## 6.2 Equipment

Barometer, thermometer and hygrometer.

## 6.3 Testing

This minimum requirement serves to verify whether AMS sensors for temperature, pressure and humidity, which are necessary for correct AMS performance, are accessible and can be checked at the field test site location. In the event, checks cannot be performed on-site, this has to be documented. AMS sensors were checked at the beginning and at the end of each field test.

## 6.4 Evaluation

The measuring system uses a weather sensor (mounted at the sampling tube below the sample inlet) to record ambient temperature and relative moisture. Air pressure is measured inside the instrument.

Relying on transfer standards, it is easily possible to perform comparison measurements on-site at any time and to adjust the sensors. The sensors' deviations remained within the required ranges.

## 6.5 Assessment

It is possible to check and adjust the sensors for determining ambient temperature, ambient pressure and relative humidity on-site. The sensors' deviations remained within the required ranges.

Criterion satisfied? yes

## 6.6 Detailed presentation of test results

Not required for this performance criterion

## **7. Recommendations for use in practice**

### **7.1 Work in the maintenance interval**

The tested measuring systems require regular performance of the following tasks:

Every month:

- Clean the sample inlet

Every quarter:

- Test the power supply
- Check sensors for temperature, pressure and moisture
- Check flow
- Automatic contamination test

Every year:

- Check the pump
- Check the voltage affecting the filter
- Calibrate sensors for temperature, pressure and moisture
- Calibrate the throughput
- Perform a leak test
- Calibrate the beta dust meter
- Check the beta dust meter (dust meter test, mass test)
- Check zero measurements

Consult the maintenance sheets in the manual for further details.

EN 16450 requires the status values of operational parameters to be checked daily (on working days).

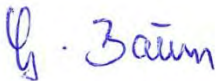
## 7.2 Additional maintenance tasks

In addition to the regular tasks to be performed during the maintenance interval, the following tasks need to be performed.

- A single filter tape collects 1200 daily averages. Thus, the filter tape must be changed after a maximum period of 3 years..
- In the event an warning is signalled for the Geiger Müller counter, this component must be replaced.

Consult the manual for further details.

Environmental Protection/Air Pollution Control



---

Dipl.-Ing. Guido Baum



---

Dipl.-Ing. Fritz Hausberg

Cologne, 15 August 2019  
936/21240384/C

## **8. Bibliography**

- [1] VDI Standard 4202, part 3, “Automated measuring systems for air quality monitoring Performance test, declaration of suitability and certification of measuring systems for point-related measurement of mass concentration for particulate air pollutants”, February 2019
- [2] VDI standard 4203, part 1, “Automated measuring systems and data evaluation systems for emission monitoring – Performance test, declaration of suitability and certification of stationary automated measuring systems and check of the quality management system of the manufacturer”, July 2017
- [3] European standard EN 12341, “Ambient air - Standard gravimetric measurement method for the determination of the PM<sub>10</sub> or PM<sub>2,5</sub> mass concentration of suspended particulate matter”; German version EN 12341:2014
- [4] European standard EN 16450 “Ambient air – Automated measuring systems for the measurement of the concentration of particulate matter (PM10; PM2.5, German version dated July 2017)
- [5] Guideline “Demonstration of Equivalence of Ambient Air Monitoring Methods”, English version dated January 2010
- [6] Operation manual MP101M, March 2019 version
- [7] Operation manual LVS3 of 2000
- [8] Directive 2008/50/EC of the European Parliament and of the Council of 21 May 2008 on ambient air quality and cleaner air for Europe

## 9. Appendix

### **Annex 1            Measured and calculated values**

- Schedule 1:        Zero level and detection limit
- Schedule 2:        Flow rate accuracy
- Schedule 3:        Temperature dependence of the zero point and sensitivity
- Schedule 4:        Independence of supply voltage
- Schedule 5:        Measured values from the field test sites

### **Annex 2:            Methods used for filter weighing**

### **Annex 3:            CE certificate and Certificate of Accreditation**

### **Annex 4:            Operation manual**

**Schedule 1**

**Zero level and Detection limit**

<b>Manufacturer</b>	ENVEA			
<b>Type</b>	MP101M, Cyclic		<b>Standards</b>	ZP Measured values with zero filter
<b>Serial-No.</b>	SN 6158 / SN 6159			

No.	Date	Measured values [ $\mu\text{g}/\text{m}^3$ ] SN 6158	Date	Measured values [ $\mu\text{g}/\text{m}^3$ ] SN 6159
1	9/11/17	1.3	9/11/2017	0.8
2	9/12/17	0.5	9/12/2017	-0.4
3	9/13/17	0.9	9/13/2017	0.5
4	9/14/17	0.1	9/14/2017	0.6
5	9/15/17	-0.4	9/15/2017	0.2
6	9/16/17	-0.3	9/16/2017	-0.3
7	9/17/17	0.3	9/17/2017	0.5
8	9/18/17	0.6	9/18/2017	0.5
9	9/19/17	0.2	9/19/2017	0.1
10	9/20/17	0.0	9/20/2017	0.4
11	9/21/17	0.2	9/21/2017	0.0
12	9/22/17	0.6	9/22/2017	0.0
13	9/23/17	0.7	9/23/2017	0.5
14	9/24/17	0.0	9/24/2017	0.7
15	9/25/17	0.4	9/25/2017	0.8
	No. of values	15	No. of values	15
	Mean (Zero level)	0.35	Mean (Zero level)	0.33
	Standard deviation $s_{x0}$	0.45	Standard deviation $s_{x0}$	0.38
	Detection limit x	1.48	Detection limit x	1.26

$$s_{x_0} = \sqrt{\left(\frac{1}{n-1}\right) \cdot \sum_{i=1,n} (x_{0i} - \bar{x}_0)^2}$$



Report on the performance test of the MP101M ambient air quality measuring system for suspended particulate matter PM10 manufactured by ENVEA, ,  
Report No.: 936/21240384/C

**Schedule 1**

**Zero level and Detection limit**

<b>Manufacturer</b>	ENVEA			
<b>Type</b>	MP101M, Periodic	<b>Standards</b>	ZP	Measured values with zero filter
<b>Serial-No.</b>	SN 6158 / SN 6159			

No.	Date	Measured values [µg/m³] SN 6158	Date	Measured values [µg/m³] SN 6159
1	9/11/2017	1.3	9/11/2017	0.8
2	9/12/2017	0.5	9/12/2017	-0.4
3	9/13/2017	0.9	9/13/2017	0.5
4	9/14/2017	0.1	9/14/2017	0.7
5	9/15/2017	-0.4	9/15/2017	0.2
6	9/16/2017	-0.3	9/16/2017	-0.4
7	9/17/2017	0.3	9/17/2017	0.5
8	9/18/2017	0.6	9/18/2017	0.6
9	9/19/2017	0.2	9/19/2017	0.2
10	9/20/2017	0.0	9/20/2017	0.4
11	9/21/2017	0.2	9/21/2017	0.0
12	9/22/2017	0.6	9/22/2017	0.1
13	9/23/2017	0.7	9/23/2017	0.5
14	9/24/2017	0.0	9/24/2017	0.7
15	9/25/2017	0.4	9/25/2017	0.8
	No. of values	15	No. of values	15
	Mean (Zero level)	0.35	Mean (Zero level)	0.33
	Standard deviation s <sub>x0</sub>	0.45	Standard deviation s <sub>x0</sub>	0.39
	Detection limit x	1.48	Detection limit x	1.28

$$s_{x_0} = \sqrt{\left(\frac{1}{n-1}\right) \cdot \sum_{i=1,n} (x_{0i} - \bar{x}_0)^2}$$

**Schedule 2**

**Flow rate accuracy**

**Page 1 of 1**

<b>Manufacturer</b>	ENVEA						<b>Nominal flow rate [l/min]</b>	16.67
<b>Type</b>	MP101M							
<b>Serial-No.</b>	SN 6158 / SN 6159							
Temperature 1	5°C	SN 6158			SN 6159			
		No.	Date/Time	Measured value [l/min]	No.	Date/Time	Measured value [l/min]	
		1	11/7/2017 12:04	16.42	1	11/7/2017 12:46	16.43	
		2	11/7/2017 12:08	16.40	2	11/7/2017 12:50	16.46	
		3	11/7/2017 12:12	16.41	3	11/7/2017 12:54	16.46	
		4	11/7/2017 12:16	16.39	4	11/7/2017 13:06	16.47	
		5	11/7/2017 12:20	16.39	5	11/7/2017 13:10	16.49	
		6	11/7/2017 12:24	16.39	6	11/7/2017 13:14	16.50	
		7	11/7/2017 12:28	16.39	7	11/7/2017 13:18	16.50	
		8	11/7/2017 12:32	16.41	8	11/7/2017 13:22	16.51	
		9	11/7/2017 12:36	16.40	9	11/7/2017 13:26	16.49	
10	11/7/2017 12:40	16.39	10	11/7/2017 13:30	16.49			
		<b>Mean</b>	<b>16.40</b>		<b>Mean</b>	<b>16.48</b>		
Temperature 2	40°C	SN 6158			SN 6159			
		No.	Date/Time	Measured value [l/min]	No.	Date/Time	Measured value [l/min]	
		1	11/8/2017 12:08	16.86	1	11/8/2017 12:48	16.87	
		2	11/8/2017 12:12	16.88	2	11/8/2017 12:53	16.88	
		3	11/8/2017 12:16	16.88	3	11/8/2017 13:05	16.88	
		4	11/8/2017 12:20	16.87	4	11/8/2017 13:09	16.87	
		5	11/8/2017 12:24	16.88	5	11/8/2017 13:13	16.87	
		6	11/8/2017 12:28	16.88	6	11/8/2017 13:17	16.87	
		7	11/8/2017 12:32	16.88	7	11/8/2017 13:21	16.88	
		8	11/8/2017 12:36	16.88	8	11/8/2017 13:25	16.89	
		9	11/8/2017 12:40	16.88	9	11/8/2017 13:29	16.89	
10	11/8/2017 12:44	16.88	10	11/8/2017 13:33	16.90			
		<b>Mean</b>	<b>16.88</b>		<b>Mean</b>	<b>16.88</b>		

**Schedule 3**

**Dependence of zero point on surrounding temperature**

<b>Manufacturer</b> ENVEA							
<b>Type</b> MP101M, Cyclic							
<b>Serial-No.</b> SN 6158 / SN 6159							
			Measurement 1	Measurement 2	Measurement 3		
SN 6158	No.	Temperature [°C]	Measured value [µg/m³]	Measured value [µg/m³]	Measured value [µg/m³]	Mean value of 3 measurements [µg/m³]	Mean value at 20°C [µg/m³]
Zero	1	20	-0.3	-0.9	-0.6	-0.6	-0.3
	2	5	0.6	0.3	0.1	0.3	
	3	20	0.5	0.6	-0.2	0.3	
	4	40	-1.6	-0.6	-0.6	-0.9	
	5	20	-1.0	-0.5	-0.6	-0.7	
SN 6159	No.	Temperature [°C]	Measured value [µg/m³]	Measured value [µg/m³]	Measured value [µg/m³]	Mean value of 3 measurements [µg/m³]	Mean value at 20°C [µg/m³]
Zero	1	20	0.5	-0.2	0.7	0.3	0.3
	2	5	0.0	0.5	-0.1	0.1	
	3	20	0.4	-0.1	-0.2	0.0	
	4	40	0.8	0.8	0.7	0.8	
	5	20	0.4	0.7	0.3	0.5	

**Schedule 3**
**Dependence of zero point on surrounding temperature**
**Page 2 of 3**

<b>Manufacturer</b> ENVEA							
<b>Type</b> MP101M, Periodic							
<b>Serial-No.</b> SN 6158 / SN 6159							
			Measurement 1	Measurement 2	Measurement 3		
SN 6158	No.	Temperature [°C]	Measured value [µg/m³]	Measured value [µg/m³]	Measured value [µg/m³]	Mean value of 3 measurements [µg/m³]	Mean value at 20°C [µg/m³]
Zero	1	20	-0.3	-0.9	-0.6	-0.6	-0.3
	2	5	0.6	0.3	0.1	0.3	
	3	20	0.5	0.6	-0.2	0.3	
	4	40	-1.5	-0.6	-0.6	-0.9	
	5	20	-1.0	-0.5	-0.6	-0.7	
SN 6159	No.	Temperature [°C]	Measured value [µg/m³]	Measured value [µg/m³]	Measured value [µg/m³]	Mean value of 3 measurements [µg/m³]	Mean value at 20°C [µg/m³]
Zero	1	20	0.5	-0.2	0.7	0.3	0.3
	2	5	-0.1	0.5	-0.1	0.1	
	3	20	0.4	-0.1	-0.2	0.0	
	4	40	0.8	0.8	0.7	0.8	
	5	20	0.3	0.7	0.3	0.5	

**Schedule 3**

**Dependence of span on surrounding temperature**

<b>Manufacturer</b> ENVEA							
<b>Type</b> MP101M							
<b>Serial-No.</b> SN 6158 / SN 6159							
<b>Used test standard</b> internal reference foil							
			Measurement 1	Measurement 2	Measurement 3		
SN 6158	No.	Temperature [°C]	Measured value [µg/cm <sup>3</sup> ]	Measured value [µg/cm <sup>3</sup> ]	Measured value [µg/cm <sup>3</sup> ]	Mean value of 3 measurements [µg/cm <sup>3</sup> ]	Mean value at 20°C [µg/cm <sup>3</sup> ]
Span	1	20	823.1	835.4	830.4	829.6	829.6
	2	5	851.0	837.5	844.1	844.2	
	3	20	818.2	832.1	836.4	828.9	
	4	40	817.1	828.6	828.1	824.6	
	5	20	826.3	839.0	825.0	830.1	
SN 6159	No.	Temperature [°C]	Measured value [µg/cm <sup>3</sup> ]	Measured value [µg/cm <sup>3</sup> ]	Measured value [µg/cm <sup>3</sup> ]	Mean value of 3 measurements [µg/cm <sup>3</sup> ]	Mean value at 20°C [µg/cm <sup>3</sup> ]
Span	1	20	830.4	835.8	844.0	836.7	835.3
	2	5	843.4	847.4	848.0	846.2	
	3	20	840.0	827.3	837.7	835.0	
	4	40	839.1	829.4	834.2	834.2	
	5	20	837.7	828.1	836.8	834.2	

**Schedule 4**
**Dependence of span on supply voltage**
**Page 1 of 1**

<b>Manufacturer</b> ENVEA		<b>Used test standard</b> internal reference foil					
<b>Type</b> MP101M							
<b>Serial-No.</b> SN 6158 / SN 6159							
			Measurement 1	Measurement 2	Measurement 3		
SN 6158	No.	Mains voltage [V]	Measured value [ $\mu\text{g}/\text{cm}^3$ ]	Measured value [ $\mu\text{g}/\text{cm}^3$ ]	Measured value [ $\mu\text{g}/\text{cm}^3$ ]	Mean value of 3 measurements [ $\mu\text{g}/\text{cm}^3$ ]	
Span	1	230	820.6	829.6	808.6	819.6	
	2	195	819.9	820.1	822.6	820.9	
	3	230	822.2	818.2	819.2	819.9	
	4	253	831.5	814.9	807.4	817.9	
	5	230	812.7	823.9	819.2	818.6	
SN 6159	No.	Mains voltage [V]	Measured value [ $\mu\text{g}/\text{cm}^3$ ]	Measured value [ $\mu\text{g}/\text{cm}^3$ ]	Measured value [ $\mu\text{g}/\text{cm}^3$ ]	Mean value of 3 measurements [ $\mu\text{g}/\text{cm}^3$ ]	
Span	1	230	825.9	829.1	826.3	827.1	
	2	195	831.6	830.1	830.5	830.8	
	3	230	828.8	821.3	824.3	824.8	
	4	253	817.1	818.4	823.6	819.7	
	5	230	816.1	817.4	824.6	819.4	

Report on the performance test of the MP101M ambient air quality measuring system for suspended particulate matter PM10 manufactured by ENVEA, ,  
Report No.: 936/21240384/C

Schedule 5

Measured values from field test sites, related to actual conditions

Manufacturer ENVEA Type of instrument MP101M Serial-No. SN 6158 / SN 6159												PM10 Measured values in µg/m³ (ACT)	
No.	Date	Ref. 1 PM2,5 [µg/m³]	Ref. 2 PM2,5 [µg/m³]	Ref. 1 PM10 [µg/m³]	Ref. 2 PM10 [µg/m³]	Ratio PM2,5/PM10 [%]	SN 6158 PM10 (Per) [µg/m³]	SN 6159 PM10 (Per) [µg/m³]	SN 6158 PM10 (Cyc) [µg/m³]	SN 6159 PM10 (Cyc) [µg/m³]	Remark	Test site	
1	11/29/2017										Zero check Zero check Change to measurement	Cologne,Winter	
2	11/30/2017												
3	12/1/2017												
4	12/2/2017						28.3	29.6	28.3	29.5			
5	12/3/2017	16.0	16.2	20.3	20.8	78.3	17.3	16.0	17.3	16.1			
6	12/4/2017	19.8	19.7	30.8	31.0	63.9	28.6	26.2	28.5	26.2			
7	12/5/2017	18.3	18.5	24.5	24.8	74.6	21.4	22.3	21.4	22.3			
8	12/6/2017	10.4	10.7	14.5	14.4	73.0	14.9	15.0	14.9	14.9			
9	12/7/2017						13.1	12.4	13.0	12.4			
10	12/8/2017	8.0	8.7	14.6	15.1	56.2	11.7	11.9	11.7	11.9			
11	12/9/2017						10.5	10.8	10.6	10.8			
12	12/10/2017						6.9	8.3	7.0	8.3			
13	12/11/2017	5.8	5.3	8.2	7.5	70.7	5.8	6.7	5.8	6.7			
14	12/12/2017	9.0	8.7	13.2	12.7	68.3	11.2	10.0	11.1	10.1			
15	12/13/2017	2.9	2.5	6.1	5.7	45.8	5.5	4.3	5.5	4.4			
16	12/14/2017	5.5	4.2	8.1	7.7	61.4	5.2	5.2	5.2	5.2			
17	12/15/2017	15.7	14.7	21.4	21.5	70.9	17.7	16.9	17.7	16.9			
18	12/16/2017						13.9	14.0	13.9	14.0			
19	12/17/2017	10.1	9.3	13.6	13.8	70.8	11.9	12.0	11.9	12.0			
20	12/18/2017	16.4	15.4	20.8	21.2	75.7	17.1	14.9	17.1	14.9			
21	12/19/2017	20.9	20.2	34.8	36.1	58.0	35.7	34.6	35.7	34.6			
22	12/20/2017	16.6	16.0	22.3	23.6	71.0	23.9	23.8	23.8	23.7			
23	12/21/2017	9.5	8.7	11.8	12.8	74.0	13.4	12.8	13.4	12.8			
24	12/22/2017	10.8	10.3	13.3	14.1	77.0	11.5	12.0	11.6	12.0			
25	12/23/2017						9.4	8.8	9.3	8.6			
26	12/24/2017						4.9	4.2	4.8	4.2			
27	12/25/2017						3.2	3.8	3.3	3.8			
28	12/26/2017						6.9	3.8	6.9	3.8			
29	12/27/2017						5.2	4.2	5.1	4.2			
30	12/28/2017						10.2	10.2	10.2	10.3			

**Schedule 5**
**Measured values from field test sites, related to actual conditions**

Page 2 of 14

Manufacturer ENVEA Type of instrument MP101M Serial-No. SN 6158 / SN 6159												PM10 Measured values in µg/m³ (ACT)	
No.	Date	Ref. 1 PM2,5 [µg/m³]	Ref. 2 PM2,5 [µg/m³]	Ref. 1 PM10 [µg/m³]	Ref. 2 PM10 [µg/m³]	Ratio PM2,5/PM10 [%]	SN 6158 PM10 (Per) [µg/m³]	SN 6159 PM10 (Per) [µg/m³]	SN 6158 PM10 (Cyc) [µg/m³]	SN 6159 PM10 (Cyc) [µg/m³]	Remark	Test site	
31	12/29/2017						7.9	9.8	8.0	9.8		Cologne, Winter	
32	12/30/2017						14.7	15.0	14.7	15.0			
33	12/31/2017	7.3	7.2	10.0	10.7	70.0	3.6	6.0	3.7	6.0			
34	1/1/2018	3.4	3.2	4.8	6.0	61.1	5.3	4.6	5.3	4.6			
35	1/2/2018	4.5	3.2	8.1	8.0	47.8	8.3	10.0	8.3	10.0			
36	1/3/2018	9.0	9.0	21.7	22.4	40.8	19.9	18.1	19.8	18.2			
37	1/4/2018						15.0	15.8	15.0	15.7			
38	1/5/2018						10.4	11.7	10.4	11.7			
39	1/6/2018						14.9	14.1	14.9	14.1			
40	1/7/2018	5.9	5.6	6.1	6.7	89.8	4.1	5.2	4.2	5.2			
41	1/8/2018						14.0	13.1	14.0	13.2			
42	1/9/2018	11.9	12.1	15.5	15.3	77.9	14.8	14.8	14.9	14.9			
43	1/10/2018	9.4	10.0	14.0	13.9	69.5	11.7	12.9	11.8	12.9			
44	1/11/2018	27.3	27.8	35.6	35.7	77.3	29.8	29.8	29.9	29.9			
45	1/12/2018	44.4	44.1	51.4	52.3	85.3	51.1	51.4	51.2	51.5			
46	1/13/2018						13.3	10.7	13.4	10.8			
47	1/14/2018	15.7	16.5	17.5	17.4	92.3	16.3	16.9	16.3	16.9			
48	1/15/2018	5.3	6.6	7.3	7.8	78.8	10.6	11.3	10.6	11.3			
49	1/16/2018						8.1	7.8	5.8	7.6	Outlier ref. PM2.5		
50	1/17/2018	5.1	4.9	11.5	11.6	43.3	10.9	10.5	11.0	10.5			
51	1/18/2018	4.3	5.3	9.7	9.9	49.0	6.4	7.3	6.4	7.4			
52	1/19/2018	5.7	6.3	11.0	11.2	54.1	9.7	9.6	9.8	9.6			
53	1/20/2018						8.1	8.6	8.2	8.6			
54	1/21/2018	6.4	7.3	9.7	10.4	68.2	8.4	10.0	8.4	10.0			
55	1/22/2018						14.1	14.1	14.2	14.2			
56	1/23/2018						8.6	6.8	8.5	6.8			
57	1/24/2018						2.2	3.0	2.2	3.0			
58	1/25/2018						8.9	9.1	8.9	9.1			
59	1/26/2018						20.4	20.9	20.4	20.9			
60	1/27/2018						11.6	12.1	11.6	12.0			



Report on the performance test of the MP101M ambient air quality measuring system for suspended particulate matter PM10 manufactured by ENVEA, ,  
Report No.: 936/21240384/C

Schedule 5

Measured values from field test sites, related to actual conditions

Manufacturer ENVEA Type of instrument MP101M Serial-No. SN 6158 / SN 6159												PM10 Measured values in µg/m³ (ACT)	
No.	Date	Ref. 1 PM2,5 [µg/m³]	Ref. 2 PM2,5 [µg/m³]	Ref. 1 PM10 [µg/m³]	Ref. 2 PM10 [µg/m³]	Ratio PM2,5/PM10 [%]	SN 6158 PM10 (Per) [µg/m³]	SN 6159 PM10 (Per) [µg/m³]	SN 6158 PM10 (Cyc) [µg/m³]	SN 6159 PM10 (Cyc) [µg/m³]	Remark	Test site	
61	1/28/2018	2.8	3.7	4.8	5.1	65.7	3.4	4.3	3.4	4.3		Cologne, Winter	
62	1/29/2018	6.3	7.4	13.1	13.3	51.9	7.6	7.4	7.6	7.4			
63	1/30/2018	8.1	8.4	13.7	13.6	60.4	16.9	14.0	16.8	14.0			
64	1/31/2018	3.5	4.1	7.1	6.6	55.5	5.6	5.0	5.6	5.0			
65	2/1/2018	6.8	7.8	11.7	12.6	60.1	9.0	9.9	9.0	9.9			
66	2/2/2018						10.7	12.0	10.8	12.0			
67	2/3/2018						11.1	11.7	11.1	11.6			
68	2/4/2018	9.1	9.3	11.8	11.9	77.6	7.0	5.9	7.0	6.0			
69	2/5/2018	12.5	12.6	16.1	15.4	79.7	14.3	14.3	14.3	14.3			
70	2/6/2018	25.1	25.7	30.7	30.4	83.1	27.5	28.2	27.5	28.2			
71	2/7/2018	40.4	41.2	50.9	51.5	79.7	46.5	44.4	46.6	44.5			
72	2/8/2018						64.8	62.9	64.9	63.0			
73	2/9/2018	25.3	25.7	29.1	29.5	87.0	32.2	30.7	32.0	30.6			
74	2/10/2018						11.5	12.6	11.5	12.6			
75	2/11/2018						5.7	6.5	5.7	6.5			
76	2/12/2018	9.1	9.5	14.6	14.9	63.1	9.8	11.8	9.9	11.8			
77	2/13/2018	11.3	11.2	15.7	16.0	71.0	11.9	13.5	11.9	13.5			
78	2/14/2018	16.4	16.8	21.1	21.4	78.1	17.7	18.3	17.7	18.2			
79	2/15/2018	18.0	18.2	25.0	25.4	71.8	20.4	20.2	20.4	20.2			
80	2/16/2018						23.3	21.7	23.4	21.8			
81	2/17/2018						22.9	25.8	22.9	25.6			
82	2/18/2018	25.9	25.7	34.2	34.0	75.7	28.3	28.7	28.3	28.7			
83	2/19/2018	26.5	26.2	34.1	34.5	76.8	29.6	29.3	29.6	29.3			
84	2/20/2018	39.0	39.4	47.5	48.2	81.9	41.0	41.3	41.0	41.4			
85	2/21/2018	31.4	31.5	38.1	38.5	82.1	36.7	36.0	36.6	35.9			
86	2/22/2018	13.5	13.5	18.4	18.6	73.0	19.4	17.2	19.4	17.2			
87	2/23/2018	14.4	14.1	17.9	18.1	79.2	18.4	16.0	18.3	16.1			
88	2/24/2018						11.7	12.6	11.7	12.6			
89	2/25/2018	7.7	7.8	9.8	10.7	75.6	9.1	8.9	9.2	8.9			
90	2/26/2018	9.3	9.5	12.3	13.6	72.6	13.1	14.3	13.1	14.3			

**Schedule 5**
**Measured values from field test sites, related to actual conditions**

Manufacturer ENVEA Type of instrument MP101M Serial-No. SN 6158 / SN 6159												PM10 Measured values in µg/m³ (ACT)	
No.	Date	Ref. 1 PM2,5 [µg/m³]	Ref. 2 PM2,5 [µg/m³]	Ref. 1 PM10 [µg/m³]	Ref. 2 PM10 [µg/m³]	Ratio PM2,5/PM10 [%]	SN 6158 PM10 (Per) [µg/m³]	SN 6159 PM10 (Per) [µg/m³]	SN 6158 PM10 (Cyc) [µg/m³]	SN 6159 PM10 (Cyc) [µg/m³]	Remark	Test site	
91	2/27/2018	11.4	11.3	15.9	16.5	70.1	15.2	14.9	15.2	14.9	Change to zero Zero check Zero check	Cologne, Winter	
92	2/28/2018	23.2	23.1	28.8	28.6	80.7	27.7	27.9	27.8	27.9			
93	3/1/2018	27.3	27.7	34.8	34.3	79.6	33.9	32.9	34.0	32.9			
94	3/2/2018						51.4	48.4	51.4	48.5			
95	3/3/2018						49.7	50.3	49.7	50.3			
96	3/4/2018												
97	3/5/2018												
98	3/6/2018												
99	3/28/2018										Zero check Zero check Zero check Change to measurement Power outage (vandalism) Power outage (vandalism) Power outage (vandalism) Power outage (vandalism)	Bonn, Belderberg	
100	3/29/2018												
101	3/30/2018												
102	3/31/2018												
103	4/1/2018												
104	4/2/2018												
105	4/3/2018												
106	4/4/2018												
107	4/5/2018						14.5	14.8	14.5	14.9			
108	4/6/2018						13.1	13.2	13.0	13.2			
109	4/7/2018						20.3	19.6	20.3	19.6			
110	4/8/2018	12.5	12.2	24.6	25.4	49.4	25.5	25.5	25.5	25.5			
111	4/9/2018	26.4	26.7	42.8	44.9	60.5	45.4	46.4	45.3	46.4			
112	4/10/2018	7.0	6.8	12.3	12.5	55.6	15.2	15.4	15.1	15.4			
113	4/11/2018	11.0	10.5	16.2	16.7	65.3	16.7	15.7	16.7	15.8			
114	4/12/2018	16.4	15.7	25.5	27.4	60.7	28.0	29.0	28.0	28.9			
115	4/13/2018	11.5	10.7	19.5	20.8	55.1	20.9	22.1	20.9	22.1			
116	4/14/2018						24.3	28.1	24.4	28.2			
117	4/15/2018	6.5	5.6	11.4	12.5	50.6	11.7	10.4	11.7	10.5			
118	4/16/2018	9.1	8.3	20.1	21.7	41.6	20.9	20.2	21.0	20.2			
119	4/17/2018	9.4	9.1	18.5	20.0	48.1	19.8	21.1	19.8	21.1			
120	4/18/2018	11.0	10.9	20.7	22.5	50.7	22.7	23.5	22.7	23.5			

Report on the performance test of the MP101M ambient air quality measuring system for suspended particulate matter PM10 manufactured by ENVEA, ,  
Report No.: 936/21240384/C

**Schedule 5**

**Measured values from field test sites, related to actual conditions**

Manufacturer ENVEA Type of instrument MP101M Serial-No. SN 6158 / SN 6159												PM10 Measured values in µg/m <sup>3</sup> (ACT)	
No.	Date	Ref. 1 PM2,5 [µg/m <sup>3</sup> ]	Ref. 2 PM2,5 [µg/m <sup>3</sup> ]	Ref. 1 PM10 [µg/m <sup>3</sup> ]	Ref. 2 PM10 [µg/m <sup>3</sup> ]	Ratio PM2,5/PM10 [%]	SN 6158 PM10 (Per) [µg/m <sup>3</sup> ]	SN 6159 PM10 (Per) [µg/m <sup>3</sup> ]	SN 6158 PM10 (Cyc) [µg/m <sup>3</sup> ]	SN 6159 PM10 (Cyc) [µg/m <sup>3</sup> ]	Remark	Test site	
121	4/19/2018	11.8	12.5	21.4	23.7	53.9	24.9	23.9	24.9	23.9		Bonn, Beiderberg	
122	4/20/2018	22.0	21.5	39.6	41.2	53.8	39.4	38.5	39.5	38.6			
123	4/21/2018	28.4	28.3	41.3	41.5	68.5	45.0	45.1	44.9	45.0			
124	4/22/2018	15.0	15.7	25.9	26.4	58.7	27.1	28.2	27.1	28.2			
125	4/23/2018	9.8	10.6	19.5	19.2	52.7	18.6	18.4	18.6	18.4			
126	4/24/2018	9.1	9.1	19.0	17.6	49.7	19.9	19.6	19.9	19.6			
127	4/25/2018						20.8	20.2	20.8	20.2			
128	4/26/2018						45.0	42.0	44.7	41.7			
129	4/27/2018						19.3	18.5	19.3	18.5			
130	4/28/2018						15.8	15.6	15.8	15.6			
131	4/29/2018						13.8	14.6	13.7	14.6			
132	4/30/2018						4.9	5.0	4.9	5.0			
133	5/1/2018						14.0	15.6	14.0	15.6			
134	5/2/2018						17.3	17.1	17.3	17.0			
135	5/3/2018	11.2	12.6	31.3	30.0	38.8	28.2	28.3	28.3	28.4			
136	5/4/2018	10.3	11.0	24.5	24.1	43.8	25.6	25.9	25.5	25.8			
137	5/5/2018						22.4	22.3	22.5	22.3			
138	5/6/2018	5.6	5.1	11.0	10.9	48.9	13.8	14.7	13.8	14.7			
139	5/7/2018						19.7	21.4	19.7	21.4			
140	5/8/2018	9.9	9.6	20.5	20.4	47.7	21.7	22.6	21.7	22.6			
141	5/9/2018						33.8	34.2	33.9	34.2			
142	5/10/2018	10.6	9.7	23.9	22.9	43.4	22.3	22.8	22.3	22.8			
143	5/11/2018	10.0	11.0	19.1	18.1	56.5	20.7	21.3	20.7	21.3			
144	5/12/2018						21.2	21.1	21.2	21.1			
145	5/13/2018	21.6	22.7	33.1	32.4	67.6	32.0	33.3	32.1	33.3			
146	5/14/2018	19.7	20.3	34.9	35.5	56.8	37.8	37.0	37.7	37.0			
147	5/15/2018	11.1	12.5	20.8	21.2	56.2	25.1	24.1	25.1	24.0			
148	5/16/2018	11.0	12.1	23.3	23.6	49.3	22.6	23.5	22.6	23.5			
149	5/17/2018	15.3	14.2	34.7	37.3	41.0	37.4	35.3	37.4	35.4			
150	5/18/2018						35.3	34.7	35.3	34.6			

**Schedule 5**
**Measured values from field test sites, related to actual conditions**

Manufacturer ENVEA Type of instrument MP101M Serial-No. SN 6158 / SN 6159												PM10 Measured values in µg/m <sup>3</sup> (ACT)	
No.	Date	Ref. 1 PM2,5 [µg/m <sup>3</sup> ]	Ref. 2 PM2,5 [µg/m <sup>3</sup> ]	Ref. 1 PM10 [µg/m <sup>3</sup> ]	Ref. 2 PM10 [µg/m <sup>3</sup> ]	Ratio PM2,5/PM10 [%]	SN 6158 PM10 (Per) [µg/m <sup>3</sup> ]	SN 6159 PM10 (Per) [µg/m <sup>3</sup> ]	SN 6158 PM10 (Cyc) [µg/m <sup>3</sup> ]	SN 6159 PM10 (Cyc) [µg/m <sup>3</sup> ]	Remark	Test site	
151	5/19/2018						37.4	36.5	37.5	36.5		Bonn, Beiderberg	
152	5/20/2018						20.3	19.3	20.2	19.2			
153	5/21/2018	10.0	10.1	15.2	15.4	65.7	16.4	17.9	16.4	17.9			
154	5/22/2018	14.9	14.4	22.4	23.1	64.4	21.8	22.6	21.8	22.6			
155	5/23/2018	15.5	14.4	24.2	25.0	60.8	28.1	28.5	28.0	28.4			
156	5/24/2018	12.2	10.8	15.7	16.1	72.3	18.3	18.1	18.2	18.1			
157	5/25/2018						18.4	19.3	18.3	19.2			
158	5/26/2018						16.4	16.5	16.4	16.5			
159	5/27/2018	10.1	9.1	15.0	16.6	60.8	17.1	16.4	17.0	16.4			
160	5/28/2018	14.8	14.8	23.4	25.7	60.3	25.4	25.5	25.4	25.6			
161	5/29/2018						30.4	31.0	30.4	31.0			
162	5/30/2018						22.9	22.1	23.1	22.1			
163	5/31/2018						18.4	18.7	18.4	18.8			
164	6/1/2018						12.0	13.8	11.9	13.8			
165	6/2/2018						11.9	13.0	11.9	13.0			
166	6/3/2018						21.7	22.2	21.7	22.3			
167	6/4/2018						27.1	26.4	27.0	26.4			
168	6/5/2018	25.7	25.0	40.0	41.1	62.5	42.4	40.9	42.4	40.9			
169	6/6/2018	14.0	14.6	31.7	34.2	43.4	33.9	36.0	33.9	35.9			
170	6/7/2018						45.5	42.7	45.4	42.6			
171	6/8/2018						43.1	45.9	43.1	45.9			
172	6/9/2018						38.7	39.4	38.6	39.2			
173	6/10/2018						29.0	29.7	29.1	29.7			
174	6/11/2018						24.1	24.3	24.0	24.3			
175	6/12/2018						19.8	20.3	19.8	20.3			
176	6/13/2018	10.4	9.5	23.0	24.0	42.3	25.3	25.1	25.2	25.1			
177	6/14/2018	13.1	13.5	36.8	39.6	34.8	43.9	45.6	42.7	44.1			
178	6/15/2018						12.7	13.3	12.6	13.3			
179	6/16/2018						14.0	13.9	14.0	13.9			
180	6/17/2018	6.2	6.3	13.0	13.5	47.2	13.4	14.1	13.4	14.1			

Report on the performance test of the MP101M ambient air quality measuring system for suspended particulate matter PM10 manufactured by ENVEA, ,  
Report No.: 936/21240384/C

Schedule 5

Measured values from field test sites, related to actual conditions

Manufacturer ENVEA Type of instrument MP101M Serial-No. SN 6158 / SN 6159												PM10 Measured values in µg/m <sup>3</sup> (ACT)	
No.	Date	Ref. 1 PM2,5 [µg/m <sup>3</sup> ]	Ref. 2 PM2,5 [µg/m <sup>3</sup> ]	Ref. 1 PM10 [µg/m <sup>3</sup> ]	Ref. 2 PM10 [µg/m <sup>3</sup> ]	Ratio PM2,5/PM10 [%]	SN 6158 PM10 (Per) [µg/m <sup>3</sup> ]	SN 6159 PM10 (Per) [µg/m <sup>3</sup> ]	SN 6158 PM10 (Cyc) [µg/m <sup>3</sup> ]	SN 6159 PM10 (Cyc) [µg/m <sup>3</sup> ]	Remark	Test site	
181	6/18/2018	6.6	7.3	16.1	17.6	41.2	19.0	17.8	19.0	17.8		Bonn, Beiderberg	
182	6/19/2018	7.3	8.0	16.9	17.8	44.1	18.1	18.3	18.1	18.3			
183	6/20/2018						38.0	35.9	38.1	36.0			
184	6/21/2018						68.1	66.3	68.0	66.4			
185	6/22/2018						38.0	37.6	37.9	37.5			
186	6/23/2018						23.9	24.1	23.9	24.1			
187	6/24/2018						18.6	19.3	18.6	19.3			
188	6/25/2018						29.0	28.9	29.0	28.9			
189	6/26/2018						45.6	45.7	45.6	45.7			
190	6/27/2018						19.5	19.0	19.4	18.8			
191	6/28/2018						23.0	23.2	23.0	23.2			
192	6/29/2018						25.5	24.6	25.4	24.5			
193	6/30/2018						16.4	15.9	16.3	15.9			
194	7/1/2018						12.7	13.3	12.7	13.2			
195	7/2/2018										Change to zero		
196	7/3/2018										Zero check		
197	7/4/2018										Zero check		
198	7/12/2018										Zero check	Bulk handling, Summer	
199	7/13/2018												
200	7/14/2018						22.1	23.8	22.0	23.8			
201	7/15/2018	6.9	6.4	15.4	16.3	42.0	13.6	15.2	13.6	15.2			
202	7/16/2018	12.1	11.8	27.6	28.8	42.4	29.3	31.3	29.2	31.2			
203	7/17/2018	11.1	10.9	24.6	25.5	43.9	27.2	30.8	27.2	30.7			
204	7/18/2018	14.4	13.2	23.8	24.7	56.9	24.1	25.8	24.1	25.8			
205	7/19/2018	17.2	16.7	30.2	30.8	55.6	29.5	31.6	29.6	31.6			
206	7/20/2018	18.2	16.7	35.6	36.7	48.3	39.9	40.4	39.9	40.4			
207	7/21/2018	16.1	16.1	28.6	27.3	57.6	28.9	28.5	28.8	28.5			
208	7/22/2018						22.8	24.0	22.8	24.0			
209	7/23/2018	17.1	16.0	26.9	26.2	62.3	29.3	30.4	29.3	30.3			
210	7/24/2018						32.1	33.0					Power outage (construction)

**Schedule 5**
**Measured values from field test sites, related to actual conditions**

Manufacturer ENVEA Type of instrument MP101M Serial-No. SN 6158 / SN 6159												PM10 Measured values in µg/m³ (ACT)	
No.	Date	Ref. 1 PM2,5 [µg/m³]	Ref. 2 PM2,5 [µg/m³]	Ref. 1 PM10 [µg/m³]	Ref. 2 PM10 [µg/m³]	Ratio PM2,5/PM10 [%]	SN 6158 PM10 (Per) [µg/m³]	SN 6159 PM10 (Per) [µg/m³]	SN 6158 PM10 (Cyc) [µg/m³]	SN 6159 PM10 (Cyc) [µg/m³]	Remark	Test site	
211	7/25/2018										Power outage (construction)	Bulk handling, Summer	
212	7/26/2018						29.8	34.8	29.3	34.6			
213	7/27/2018						26.7	28.5	26.7	28.5			
214	7/28/2018						21.1	24.4	21.1	24.3			
215	7/29/2018						15.0	15.5	15.0	15.5			
216	7/30/2018	10.0	10.1	25.7	25.9	39.0	25.0	26.3	25.0	26.3			
217	7/31/2018	8.5	7.8	20.3	21.9	38.6	26.1	26.7	26.1	26.6			
218	8/1/2018	10.8	9.8	23.5	23.2	44.1	23.4	26.4	23.4	26.4			
219	8/2/2018	16.1	16.3	31.9	30.8	51.7	38.9	38.8	38.8	38.7			
220	8/3/2018	16.1	16.9	30.2	29.4	55.4	37.0	37.1	36.8	37.0			
221	8/4/2018						19.7	21.0	19.7	21.0			
222	8/5/2018	5.5	6.1	11.6	11.6	50.0	13.4	12.8	13.4	12.8			
223	8/6/2018						22.6	24.1	22.7	24.1			
224	8/7/2018						48.9	50.2	49.0	50.0			
225	8/8/2018	9.1	9.1	18.8	17.6	50.0	23.4	22.8	23.3	22.8			
226	8/9/2018	12.0	12.2	36.1	34.5	34.3	39.9	38.5	39.9	38.5			
227	8/10/2018	7.0	7.5	21.6	20.5	34.4	27.3	28.4	27.3	28.4			
228	8/11/2018						14.0	13.9	14.0	14.0			
229	8/12/2018	6.4	6.5	10.8	9.5	63.5	11.8	14.4	11.8	14.4			
230	8/13/2018	8.7	9.3	27.1	25.9	34.0	26.1	26.7	26.2	26.7			
231	8/14/2018	11.2	11.4	29.2	28.5	39.2	33.9	32.3	33.9	32.2			
232	8/15/2018	7.2	8.0	18.8	18.2	41.1	21.1	20.8	21.1	20.8			
233	8/16/2018						25.8	24.6	25.8	24.6			
234	8/17/2018	7.9	8.1	16.3	16.2	49.2	17.0	16.6	17.0	16.6			
235	8/18/2018						18.1	18.7	18.2	18.7			
236	8/19/2018	8.4	8.3	19.6	19.9	42.3	21.0	20.6	21.0	20.6			
237	8/20/2018	8.4	8.0	16.9	17.8	47.3	19.5	18.0	19.4	18.0			
238	8/21/2018	9.5	9.1	16.2	17.2	55.7	19.6	19.6	19.6	19.6			
239	8/22/2018	23.2	23.2	35.7	37.2	63.6	36.5	35.7	36.7	35.9			
240	8/23/2018	10.5	10.0	24.8	26.0	40.4	32.4	30.8	32.3	30.7			

Report on the performance test of the MP101M ambient air quality measuring system for suspended particulate matter PM10 manufactured by ENVEA, ,  
Report No.: 936/21240384/C

Schedule 5

Measured values from field test sites, related to actual conditions

Manufacturer ENVEA Type of instrument MP101M Serial-No. SN 6158 / SN 6159												PM10 Measured values in µg/m³ (ACT)	
No.	Date	Ref. 1 PM2,5 [µg/m³]	Ref. 2 PM2,5 [µg/m³]	Ref. 1 PM10 [µg/m³]	Ref. 2 PM10 [µg/m³]	Ratio PM2,5/PM10 [%]	SN 6158 PM10 (Per) [µg/m³]	SN 6159 PM10 (Per) [µg/m³]	SN 6158 PM10 (Cyc) [µg/m³]	SN 6159 PM10 (Cyc) [µg/m³]	Remark	Test site	
241	8/24/2018						26.9	25.4	26.7	25.3		Bulk handling, Summer	
242	8/25/2018						13.3	13.6	13.3	13.6			
243	8/26/2018	3.7	3.7	5.7	6.5	60.7	9.5	8.0	9.5	8.0			
244	8/27/2018	11.1	11.6	34.2	35.3	41.8	41.8	37.4	42.0	37.5			
245	8/28/2018	8.9	9.8	21.3	22.3	42.9	26.2	25.2	26.1	25.1			
246	8/29/2018	18.1	17.7	29.5	30.3	59.9	35.2	32.8	35.2	32.7			
247	8/30/2018						18.7	18.2	18.3	17.5			
248	8/31/2018										Change to zero Zero check zero check		
249	9/1/2018												
250	9/2/2018												
251	9/3/2018						28.5	29.1	28.6	29.2			
252	9/4/2018	20.1	19.7	29.4	28.8	68.2	28.0	29.1	27.7	28.8			
253	9/5/2018	24.9	24.4	34.9	34.6	70.9	32.1	37.3	32.1	37.4			
254	9/6/2018	18.6	19.0	27.7	26.9	68.8	21.1	23.7	21.1	23.7			
255	9/7/2018						20.1	19.3	20.1	19.3			
256	9/8/2018						14.2	13.6	14.1	13.6			
257	9/9/2018	7.1	7.3	15.1	14.8	48.1	13.1	13.1	13.1	13.1			
258	9/10/2018	9.0	9.4	29.9	29.8	30.9	29.1	30.2	29.1	30.2			
259	9/11/2018	9.4	9.0	27.9	27.1	33.6	30.1	30.0	30.1	29.9			
260	9/12/2018						18.7	21.4	17.4	21.3			
261	9/13/2018	12.7	11.8	19.2	19.3	63.7	20.5	19.0	20.4	19.1			
262	9/14/2018						40.8	41.8	40.9	41.8			
263	9/15/2018						43.9	44.7	42.8	43.5			
264	9/16/2018	10.1	9.7	19.8	20.4	49.1	16.7	19.0	16.6	19.0			
265	9/17/2018	12.5	12.1	32.6	30.4	39.1	32.5	31.8	32.5	31.8			
266	9/18/2018	14.8	14.1	38.9	38.7	37.3	42.8	44.6	42.8	44.7			
267	9/19/2018	18.1	17.6	52.3	54.1	33.6	53.8	56.2	53.9	56.3			
268	9/20/2018						44.0	50.1	43.8	49.8			
269	9/21/2018						40.1	43.7	39.9	43.2			
270	9/22/2018						16.7	18.9	16.7	18.9			

**Schedule 5**
**Measured values from field test sites, related to actual conditions**

Manufacturer ENVEA Type of instrument MP101M Serial-No. SN 6158 / SN 6159												PM10 Measured values in µg/m³ (ACT)	
No.	Date	Ref. 1 PM2,5 [µg/m³]	Ref. 2 PM2,5 [µg/m³]	Ref. 1 PM10 [µg/m³]	Ref. 2 PM10 [µg/m³]	Ratio PM2,5/PM10 [%]	SN 6158 PM10 (Per) [µg/m³]	SN 6159 PM10 (Per) [µg/m³]	SN 6158 PM10 (Cyc) [µg/m³]	SN 6159 PM10 (Cyc) [µg/m³]	Remark	Test site	
271	9/23/2018						3.5	3.9	3.5	3.8		Bulk handling, Summer	
272	9/24/2018						13.4	14.5	13.9	15.1			
273	9/25/2018	6.6	6.3	15.4	15.9	41.0	14.8	15.8	14.8	15.8			
274	9/26/2018	9.1	9.3	19.2	19.9	47.0	19.4	19.7	19.4	19.7			
275	9/27/2018	12.5	12.3	26.8	26.9	46.2	25.6	27.3	25.6	27.3			
276	9/28/2018						20.1	20.0	20.0	20.0			
277	9/29/2018						12.9	14.2	12.9	14.1			
278	9/30/2018						20.0	20.9	20.1	20.9			
279	10/1/2018	6.5	6.3	19.2	19.3	33.3	18.5	20.1	18.5	20.1			
280	10/2/2018						29.2	30.2	29.1	30.2			
281	10/3/2018						29.4	31.7	29.5	31.8			
282	10/4/2018	9.4	9.8	18.5	19.1	51.0	17.6	19.3	17.5	19.3			
283	10/5/2018						23.1	23.2	23.1	23.2			
284	10/6/2018						26.1	28.5	26.2	28.5			
285	10/7/2018						8.3	8.7	8.3	8.6			
286	10/8/2018	16.9	16.4	30.7	29.8	55.1	26.1	27.2	26.1	27.2			
287	10/9/2018	19.3	19.4	31.7	31.8	60.9	30.5	32.6	30.5	32.6			
288	10/10/2018	15.2	15.0	23.4	23.3	64.8	24.5	25.5	24.5	25.5			
289	10/11/2018						26.3	27.7	26.2	27.7			
290	10/12/2018						26.5	28.8	26.6	28.8			
291	10/13/2018						20.0	20.5	19.9	20.5			
292	10/14/2018	13.6	13.3	20.3	20.6	65.8	17.6	20.3	17.6	20.3			
293	10/15/2018	13.8	13.5	26.4	26.8	51.2	25.0	27.4	24.9	27.3			
294	10/16/2018						30.1	31.1					
295	10/17/2018						53.0	51.6	53.9	53.4			
296	10/18/2018						23.1	24.5	23.0	24.4			
297	10/19/2018						25.7	27.9	25.7	27.9			
298	10/20/2018						24.3	25.7	24.3	25.7			
299	10/21/2018						18.2	18.0	18.2	18.0			
300	10/22/2018						23.2	25.4	23.1	25.3			



Report on the performance test of the MP101M ambient air quality measuring system for suspended particulate matter PM10 manufactured by ENVEA, ,  
Report No.: 936/21240384/C

Schedule 5

Measured values from field test sites, related to actual conditions

Manufacturer ENVEA Type of instrument MP101M Serial-No. SN 6158 / SN 6159												PM10 Measured values in µg/m³ (ACT)	
No.	Date	Ref. 1 PM2,5 [µg/m³]	Ref. 2 PM2,5 [µg/m³]	Ref. 1 PM10 [µg/m³]	Ref. 2 PM10 [µg/m³]	Ratio PM2,5/PM10 [%]	SN 6158 PM10 (Per) [µg/m³]	SN 6159 PM10 (Per) [µg/m³]	SN 6158 PM10 (Cyc) [µg/m³]	SN 6159 PM10 (Cyc) [µg/m³]	Remark	Test site	
301	10/23/2018						41.6	44.7	41.5	44.7		Bulk handling, Summer	
302	10/24/2018						13.2	14.2	13.2	14.2			
303	10/25/2018						30.7	30.8	30.7	30.8			
304	10/26/2018						26.7	28.4	26.7	28.3			
305	10/27/2018						16.4	16.8	16.4	16.8			
306	10/28/2018						7.8	7.6	7.8	7.6			
307	10/29/2018						8.0	9.4	8.0	9.4			
308	10/30/2018						4.1	3.6	4.0	3.5			
309	10/31/2018						10.2	9.6	10.2	9.6			
310	11/1/2018						9.2	9.4	9.2	9.4			
311	11/2/2018						19.9	20.0	20.0	20.1			
312	11/3/2018						20.4	20.9	20.4	21.0			
313	11/4/2018	14.8	14.5	18.1	19.0	78.9	19.7	18.5	19.6	18.5			
314	11/5/2018	15.6	15.5	23.3	23.5	66.5	23.3	22.5	23.3	22.6			
315	11/6/2018	12.3	12.7	19.5	20.3	63.0	20.2	21.0	20.2	21.0			
316	11/7/2018	4.7	4.6	11.8	11.8	39.4	12.0	13.9	12.0	13.9			
317	11/8/2018	9.0	8.6	16.9	17.2	51.6	14.9	16.2	15.0	16.2			
318	11/9/2018						21.4	22.4	21.4	22.4			
319	11/10/2018						7.1	6.8	7.0	6.7			
320	11/11/2018	3.2	3.4	6.4	5.8	54.4	4.6	4.8	4.6	4.8			
321	11/12/2018	6.8	6.6	11.5	11.3	58.5	10.0	10.5	10.0	10.5			
322	11/13/2018	7.3	7.3	20.7	19.7	35.9	19.2	20.0	19.3	20.1			
323	11/14/2018	10.5	10.8	17.0	16.8	63.0	16.5	17.0	16.5	17.0			
324	11/15/2018	14.0	14.1	19.8	19.4	71.7	18.2	19.4	18.2	19.5			
325	11/16/2018						22.5	24.5	22.5	24.5			
326	11/17/2018						14.7	14.2	14.7	14.2			
327	11/18/2018	13.6	13.3	16.8	16.4	80.8	17.9	17.5	17.9	17.5			
328	11/19/2018	8.6	8.2	16.4	16.6	50.8	21.9	22.2	21.9	22.3			
329	11/20/2018	15.7	15.8	24.0	24.6	64.8	23.8	26.2	23.8	26.2			
330	11/21/2018	18.5	18.6	25.2	24.4	74.9	22.2	24.1	22.2	24.1			

**Schedule 5**
**Measured values from field test sites, related to actual conditions**

Manufacturer ENVEA Type of instrument MP101M Serial-No. SN 6158 / SN 6159												PM10 Measured values in µg/m³ (ACT)	
No.	Date	Ref. 1 PM2,5 [µg/m³]	Ref. 2 PM2,5 [µg/m³]	Ref. 1 PM10 [µg/m³]	Ref. 2. PM10 [µg/m³]	Ratio PM2,5/PM10 [%]	SN 6158 PM10 (Per) [µg/m³]	SN 6159 PM10 (Per) [µg/m³]	SN 6158 PM10 (Cyc) [µg/m³]	SN 6159 PM10 (Cyc) [µg/m³]	Remark	Test site	
331	11/22/2018						27.7	28.2	27.7	28.2		Bulk handling, Summer	
332	11/23/2018						33.6	33.5	33.7	33.5			
333	11/24/2018						13.3	13.8	13.3	13.7			
334	11/25/2018						19.8	22.5	19.8	22.5			
335	11/26/2018						21.1	20.7	21.1	20.7			
336	11/27/2018										Change to zero		
337	11/28/2018										Zero check		
338	11/29/2018										Zero check		
339	12/12/2018										Zero check	Bulk handling, Winter	
340	12/13/2018										Zero check		
341	12/14/2018										Zero check		
342	12/15/2018										Change to measurement		
343	12/16/2018												
344	12/17/2018												
345	12/18/2018						9.4	11.8	9.6	11.7			
346	12/19/2018	4.6	5.4	7.8	8.1	63.0	8.4	7.6	8.5	7.6			
347	12/20/2018	3.3	3.4	5.5	6.2	57.3	6.1	6.0	6.2	6.0			
348	12/21/2018						14.9	15.2	14.9	15.2			
349	12/22/2018						14.3	12.6	14.3	12.7			
350	12/23/2018						7.4	7.9	7.4	7.9			
351	12/24/2018						7.7	5.6	7.7	5.6			
352	12/25/2018						18.0	19.0	18.0	19.0			
353	12/26/2018						15.7	16.4	15.7	16.4			
354	12/27/2018						20.5	19.6	20.6	19.7			
355	12/28/2018						31.2	30.5	31.2	30.6			
356	12/29/2018						14.6	15.1	14.6	15.1			
357	12/30/2018						12.2	11.9	12.2	11.9			
358	12/31/2018						26.9	26.4	27.0	26.4			
359	1/1/2019	6.6	6.9	15.3	15.6	43.7	13.3	12.8	13.3	12.8			
360	1/2/2019	11.7	11.7	26.0	26.2	44.7	24.3	24.7	24.3	24.7			

Report on the performance test of the MP101M ambient air quality measuring system for suspended particulate matter PM10 manufactured by ENVEA, ,  
Report No.: 936/21240384/C

Schedule 5

Measured values from field test sites, related to actual conditions

Manufacturer ENVEA Type of instrument MP101M Serial-No. SN 6158 / SN 6159												PM10 Measured values in µg/m³ (ACT)	
No.	Date	Ref. 1 PM2,5 [µg/m³]	Ref. 2 PM2,5 [µg/m³]	Ref. 1 PM10 [µg/m³]	Ref. 2 PM10 [µg/m³]	Ratio PM2,5/PM10 [%]	SN 6158 PM10 (Per) [µg/m³]	SN 6159 PM10 (Per) [µg/m³]	SN 6158 PM10 (Cyc) [µg/m³]	SN 6159 PM10 (Cyc) [µg/m³]	Remark	Test site	
361	1/3/2019						18.6	18.1	18.6	18.1		Bulk handling, Winter	
362	1/4/2019						24.3	25.8	24.3	25.7			
363	1/5/2019						9.4	9.1	9.4	9.2			
364	1/6/2019	20.4	21.1	27.8	28.4	73.9	22.1	22.1	22.1	22.2			
365	1/7/2019	13.4	13.5	27.2	28.1	48.6	28.2	28.9	28.1	28.8			
366	1/8/2019	4.3	5.0	11.7	12.3	39.1	11.7	11.7	11.7	11.7			
367	1/9/2019	6.4	6.4	15.3	14.7	42.6	11.7	11.3	11.7	11.3			
368	1/10/2019	17.1	17.7	28.9	28.9	60.1	27.6	28.5	27.7	28.6			
369	1/11/2019	9.9	10.1	13.8	14.3	70.9	13.8	14.1	13.8	14.0			
370	1/12/2019						21.2	21.2	21.3	21.1			
371	1/13/2019	3.7	4.6	7.9	7.9	52.4	6.1	5.9	6.1	5.9			
372	1/14/2019	7.8	7.7	18.0	18.3	42.8	18.8	18.1	18.7	18.1			
373	1/15/2019						44.5	44.3	44.6	44.3	Device error ref. PM2.5		
374	1/16/2019	7.5	7.5	12.0	13.1	59.7	13.9	13.6	13.9	13.6			
375	1/17/2019	9.1	8.2	11.5	12.3	72.6	7.1	7.8	7.1	7.8			
376	1/18/2019	16.2	16.0	20.2	21.2	77.9	17.8	18.1	17.8	18.0			
377	1/19/2019						13.5	11.9	13.5	11.9			
378	1/20/2019	25.9	26.1	29.9	30.4	86.1	25.2	24.0	25.2	24.1			
379	1/21/2019	37.1	37.0				36.8	39.6	36.9	39.6	Device error ref. PM10		
380	1/22/2019	29.4	29.6	32.9	33.3	89.2	31.8	31.5	31.8	31.5			
381	1/23/2019	32.1	32.2	36.2	36.9	87.9	29.6	29.1	29.6	29.1			
382	1/24/2019	51.6	51.5	59.7	59.8	86.2	50.7	50.0	50.8	50.0			
383	1/25/2019	17.9	17.8	23.4	23.7	75.8	24.7	24.7	24.5	24.6			
384	1/26/2019						11.6	11.0	11.6	11.0			
385	1/27/2019	7.8	8.0	21.9	21.6	36.4	13.3	13.8	13.3	13.9			
386	1/28/2019	7.8	8.5	18.7	18.6	43.7	15.7	14.5	15.7	14.4			
387	1/29/2019	9.4	9.3	14.6	13.7	66.1	16.2	15.8	16.1	15.8			
388	1/30/2019	13.0	13.2	17.4	17.7	74.5	16.4	15.4	16.4	15.4			
389	1/31/2019	11.4	11.6	10.9	12.5	98.5	13.7	12.6	13.7	12.6			
390	2/1/2019						14.9	14.4	14.9	14.4			

**Schedule 5**
**Measured values from field test sites, related to actual conditions**

Manufacturer ENVEA Type of instrument MP101M Serial-No. SN 6158 / SN 6159												PM10 Measured values in µg/m³ (ACT)	
No.	Date	Ref. 1 PM2,5 [µg/m³]	Ref. 2 PM2,5 [µg/m³]	Ref. 1 PM10 [µg/m³]	Ref. 2 PM10 [µg/m³]	Ratio PM2,5/PM10 [%]	SN 6158 PM10 (Per) [µg/m³]	SN 6159 PM10 (Per) [µg/m³]	SN 6158 PM10 (Cyc) [µg/m³]	SN 6159 PM10 (Cyc) [µg/m³]	Remark	Test site	
391	2/2/2019						30.3	30.0	30.3	30.1		Bulk handling, Winter	
392	2/3/2019	14.3	14.1	18.3	19.5	75.1	20.0	20.1	19.9	20.1			
393	2/4/2019	7.6	7.1	8.5	9.6	80.9	11.3	10.6	11.3	10.5			
394	2/5/2019						12.7	11.9	12.7	11.9			
395	2/6/2019						16.0	17.2	16.4	17.6			
396	2/7/2019	5.8	6.0	13.6	14.1	42.7	14.7	14.8	14.7	14.9			
397	2/8/2019						10.5	10.6	10.5	10.6			
398	2/9/2019						15.9	16.2	15.9	16.2			
399	2/10/2019	5.0	5.4	14.1	15.4	35.4	12.6	13.2	12.7	13.2			
400	2/11/2019	8.8	9.6	23.1	23.7	39.5	20.8	19.9	20.7	20.0			
401	2/12/2019	10.6	10.9	21.4	22.5	49.0	20.3	22.4	20.3	22.3			
402	2/13/2019	14.4	14.4	22.2	22.6	64.2	21.2	19.5	21.2	19.6			
403	2/14/2019	13.1	13.1	23.4	23.0	56.5	21.9	22.3	21.9	22.3			
404	2/15/2019	12.3	12.0	20.7	21.1	58.0	22.6	22.6	22.6	22.6			
405	2/16/2019						27.3	25.9	27.3	25.9			
406	2/17/2019	17.8	18.3	23.2	22.2	79.6	22.7	21.7	22.7	21.6			
407	2/18/2019	17.1	17.2	32.0	32.2	53.4	33.8	31.5	33.8	31.5			
408	2/19/2019	13.1	12.1	30.7	31.7	40.4	31.5	31.2	31.4	31.2			
409	2/20/2019	18.8	17.8	30.9	31.8	58.4	27.9	28.5	27.9	28.5			
410	2/21/2019	25.9	25.2	36.7	37.5	68.8	35.6	35.8	35.6	35.9			
411	2/22/2019	13.0	13.0	14.7	15.6	86.2	14.1	13.7	14.1	13.7			
412	2/23/2019						14.1	13.9	14.1	13.9			
413	2/24/2019	11.6	11.8	19.2	19.7	60.2	16.7	16.0	16.7	16.0			
414	2/25/2019	15.3	14.5	29.8	30.0	49.9	31.3	29.6	31.3	29.6			
415	2/26/2019	16.3	16.2	38.0	39.1	42.1	36.2	34.4	36.2	34.4			
416	2/27/2019	23.1	22.4	44.6	44.9	50.8	44.5	43.7	44.5	43.8			
417	2/28/2019						39.6	39.5	39.5	39.4			
418													
419	4/4/2019										Zero check		
420	4/5/2019										Zero check		

## Annex 2:

### Methods used for filter weighing

#### Performance of weighing and handling of the filters

Weighing takes place in an air-conditioned weighing chamber. Conditions are as follows: 20 °C ±1 °C and 45% ± 50% rel. humidity and thus meet the requirements of EN 12341.

Filters for the field test are weighed manually. For further processing, filters incl. the control filters are placed sieves to avoid cross-loading.

Conditions for initial and back weighing had previously been defined and are in line with the specifications of standard EN 12341.

Before sampling = initial weighing	After sampling = back weighing
Conditioning > 48 hours	Conditioning > 48 hours
Filter weighing	Filter weighing
Repeated conditioning > 12 hours	Repeated conditioning 24 to 72 hours
Filter weighing and immediate packaging	Filter weighing

Blank value samples both from the weighing chamber and the field are used for the purpose of quality assurance. In doing so, the requirements of standard EN 12341 are taken into account.

Weighed filters are separately kept in polystyrene boxes for transports to and from the measurement site and for storage. The box is not opened until the filter is inserted in the filter cartridge. Virgin filters shall be stored no longer than 2 months before sampling. Should this period be exceeded, initial weighing will be repeated.

Loaded filters must be brought to the weighing chamber within the month. They are then weighed within a month.

## Appendix 3 CE certificate and Certificate of Accreditation



**EC DECLARATION OF CONFORMITY**  
In accordance with EN ISO 17050-2:2004

<b>ORIGINAL MANUFACTURER</b>  <b>ENVEA - FRANCE</b>
<b>PRODUCT DESCRIPTION</b>  <b>MP101M-C – Color Beta Gauge ambient suspended particulate monitor</b>

The above described product is declared conformed to the following dispositions:

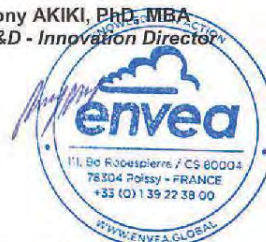
- The Directive 2017/2102/UE of the European Parliament and of the Council on machinery, dated November 15<sup>th</sup> 2017 on the restriction of the use of certain hazardous substances in electrical and electronic equipment
- The Directive 2006/42/CE of the European Parliament and of the Council on machinery, dated May 17<sup>th</sup>, 2006 (replacing the Directive 1998/37/EC from December 30<sup>th</sup>, 2009)
- The Directive 2014/30/UE of the European Union Council, dated February 26<sup>th</sup> 2014 (replacing the Directive 2004/108/CEE) relating to electromagnetic compatibility.
- The Directive 2014/35/UE of the European Union Council, dated February 26<sup>th</sup> 2014 (replacing the Directive 2006/95/CEE) relating to the making available on the market of electrical equipment designed for use within certain voltage limits

This conformity is presumed in reference to the following specifications:

<b>EN 61326-1: 2013</b>	Electrical equipment for measurement, control and laboratory use-EMC requirement	
	EN 55011:2009 + A1:2010	"Class A" verified
	EN 61000-3-2: 2006 + A1/A2: 2009	
	EN 61000-3-3: 2013	
	EN 61000-4-2: 2008	
	EN 61000-4-3: 2006 + A2: 2010	with few frequencies susceptibilities
	EN 61000-4-4: 2012	
	EN 61000-4-5: 2006	
	EN 61000-4-6: 2008	
	EN 61000-4-11: 2004	"A Criteria" verified
<b>EN 61010-1</b>	Safety requirements for electrical equipment for measurement, control and laboratory use	

Poissy, June 27<sup>th</sup> 2019

**Rony AKIKI, PhD, MBA**  
**R&D - Innovation Director**



ENVEA – 111, Boulevard Robespierre / CS 80004 – 78304 Poissy Cedex – FRANCE  
Tel: +33(0)1 39 22 38 00 – Fax: +33(0)1 39 65 38 08 – www.envea.global – info@environnement-sa.com  
Limited Company – Capital 9 585 900 € – R.C.S Versailles B 313 997 223 – Siret 313 997 223 000 18 – APE 2651B – VAT FR 43 313 997 223

ENVEA, the new corporate name of Environnement S.A



Figure 51: CE certificate





## Deutsche Akkreditierungsstelle GmbH

Beliehene gemäß § 8 Absatz 1 AkkStelleG i.V.m. § 1 Absatz 1 AkkStelleGBV  
Unterzeichnerin der Multilateralen Abkommen  
von EA, ILAC und IAF zur gegenseitigen Anerkennung

## Akkreditierung



Die Deutsche Akkreditierungsstelle GmbH bestätigt hiermit, dass das Prüflaboratorium

### TÜV Rheinland Energy GmbH

mit seinen in der Urkundenanlage aufgeführten Messstellen

die Kompetenz nach DIN EN ISO/IEC 17025:2005 besitzt, Prüfungen in folgenden Bereichen durchzuführen:

Bestimmung (Probenahme und Analytik) von anorganischen und organischen gas- oder partikel-förmigen Luftinhaltsstoffen im Rahmen von Emissions- und Immissionsmessungen; Probenahme von luftgetragenen polyhalogenierten Dibenzo-p-Dioxinen und Dibenzofuranen bei Emissionen und Immissionen; Probenahme von faserförmigen Partikeln bei Emissionen und Immissionen; Ermittlung von gas- oder partikelförmigen Luftinhaltsstoffen mit kontinuierlich arbeitenden Messgeräten; Bestimmung von Geruchsstoffen in Luft; Kalibrierungen und Funktionsprüfungen kontinuierlich arbeitender Messgeräte für Luftinhaltsstoffe einschließlich Systemen zur Datenauswertung und Emissionsfernüberwachung; Feuerraummessungen; Eignungsprüfungen von automatisch arbeitenden Emissions- und Immissionsmessenrichtungen einschließlich Systemen zur Datenauswertung und Emissionsfernüberwachung; Ermittlung der Emissionen und Immissionen von Geräuschen; Ermittlung von Geräuschen und Vibrationen am Arbeitsplatz; akustische und schwingungstechnische Messungen im Eisenbahnwesen; Bestimmung von Schalleistungspegeln von zur Verwendung im Freien vorgesehenen Geräten und Maschinen nach Richtlinie 2000/14/EG und Konformitätsbewertungsverfahren; Schornsteinhöhenberechnung und Immissionsprognose auf der Grundlage der Technischen Anleitung zur Reinhaltung der Luft und der Geruchsimmisions-Richtlinie und der VDI 3783 Blatt 13; Windenergieanlagen: Bestimmung von Windpotential, Energieerträgen, Standorterträgen und Standortgüte nach EEG, standortbezogenen Turbulenzcharakteristika und Extremwinde; Schallimmissionsprognosen, Schattenwurfimmissionsberechnung und Sichtbarkeitsbestimmung; Probenahme und mikrobiologische Untersuchungen von Nutzwasser gemäß §3 Absatz 8 42. BImSchV; physikalische, physikalisch-chemische und mikrobiologische Untersuchungen von Wasser (Abwasser, Wasser aus Rückkühlwerken sowie raumlufttechnischen Anlagen); Probenahme von Abwasser; mikrobiologische und ausgewählte chemische Untersuchungen gemäß Trinkwasserverordnung; Probenahme von Roh- und Trinkwasser; ausgewählte mikrobiologische Untersuchungen von Bedarfsgegenständen und kosmetischen Mitteln; Probenahme anorganischer faserförmiger Partikel sowie von partikel- und gasförmigen luftverunreinigenden Stoffen in der Innenraumluft; ausgewählte mikrobiologische Untersuchungen in Innenräumen; Ermittlung von Aerosolen und Faserstäuben, anorganischen und organischen Gasen und Dämpfen sowie ausgewählten Parametern und/oder in ausgewählten Gebieten bei Arbeitsplatzmessungen gemäß Gefahrstoffverordnung §7, Abs. 10; Modul Immissionsschutz

Die Akkreditierungsurkunde gilt nur in Verbindung mit dem Bescheid vom 02.08.2018 mit der Akkreditierungsnummer D-PL-11120-02-00 und ist gültig bis 10.12.2022. Sie besteht aus diesem Deckblatt, der Rückseite des Deckblatts und der folgenden Anlage mit insgesamt 55 Seiten.

Registrierungsnummer der Urkunde: **D-PL-11120-02-00**

Berlin, 02.08.2018

  
Im Auftrag Dipl.-Ing. Andrea Valbuena  
Abteilungsleiterin

Siehe Hinweise auf der Rückseite

Figure 52: Certificate of accreditation according to EN ISO/IEC 17025:2005



## Deutsche Akkreditierungsstelle GmbH

Standort Berlin  
Spittelmarkt 10  
10117 Berlin

Standort Frankfurt am Main  
Europa-Allee 52  
60327 Frankfurt am Main

Standort Braunschweig  
Bundesallee 100  
38116 Braunschweig

Die auszugsweise Veröffentlichung der Akkreditierungsurkunde bedarf der vorherigen schriftlichen Zustimmung der Deutsche Akkreditierungsstelle GmbH (DAkkS). Ausgenommen davon ist die separate Weiterverbreitung des Deckblattes durch die umseitig genannte Konformitätsbewertungsstelle in unveränderter Form.

Es darf nicht der Anschein erweckt werden, dass sich die Akkreditierung auch auf Bereiche erstreckt, die über den durch die DAkkS bestätigten Akkreditierungsbereich hinausgehen.

Die Akkreditierung erfolgte gemäß des Gesetzes über die Akkreditierungsstelle (AkkStelleG) vom 31. Juli 2009 (BGBl. I S. 2625) sowie der Verordnung (EG) Nr. 765/2008 des Europäischen Parlaments und des Rates vom 9. Juli 2008 über die Vorschriften für die Akkreditierung und Marktüberwachung im Zusammenhang mit der Vermarktung von Produkten (Abl. L 218 vom 9. Juli 2008, S. 30). Die DAkkS ist Unterzeichnerin der Multilateralen Abkommen zur gegenseitigen Anerkennung der European co-operation for Accreditation (EA), des International Accreditation Forum (IAF) und der International Laboratory Accreditation Cooperation (ILAC). Die Unterzeichner dieser Abkommen erkennen ihre Akkreditierungen gegenseitig an.

Der aktuelle Stand der Mitgliedschaft kann folgenden Webseiten entnommen werden:  
EA: [www.european-accreditation.org](http://www.european-accreditation.org)  
ILAC: [www.ilac.org](http://www.ilac.org)  
IAF: [www.iaf.nu](http://www.iaf.nu)

Figure 53: Certificate of accreditation according to EN ISO/IEC 17025:2005 - page 2

## **Appendix 4: Operation manual**

TECHNICAL MANUAL

# MP101M

## SUSPENDED PARTICULATE BETA GAUGE MONITOR

- SEPTEMBER 2019 -



**WARNING**

The information in this documentation is subject to change without notice.  
ENVEA all rights reserved.  
This document does not represent a commitment on behalf of ENVEA.

---

## Warranty

### Defects that fall under warranty

The seller shall undertake to remedy any operational malfunction resulting from a manufactured or material defect within the limits of the provision below.

The seller shall not be liable in the case of a defect caused either by materials supplied by the buyer or by a design imposed by the buyer.

Any warranty is also invalid in the case of damage resulting from normal wear and tear, accident, disaster, misuse, fault or negligence of or by Buyer, causes external to the Products such as, but not limited to, unauthorized repairs or part replacement, electrical power surges, improper storage of the Product, use of the Product in a manner for which it was not designed.

### Duration and starting point of the warranty

Unless otherwise stipulated, the warranty period shall have a duration of twelve months from the date of delivery within the meaning of article 6 paragraph 2 of the «ENVEA: 2013 INTERNATIONAL GENERAL TERMS AND CONDITIONS OF SALES», even if the shipment or assembly is postponed for any reason outside the seller's control.

Unless agreed upon by both parties, the repair, modification or replacement of parts during the warranty period will not extend or renew the original equipment warranty period.

### Buyer's obligation

In order to file a claim under warranty, the buyer must notify the seller immediately in writing of any defect in the equipment and supply evidence in proof thereof. The buyer must provide the seller with the opportunity to observe and remedy the said defects. In addition, the buyer must not carry out any repairs or have repairs made by a third party without the written agreement of the seller.

The buyer is required to check the equipment as soon as possible upon receipt and acceptance and no later than eight days following receipt. Failing to do so might invalidate any claims made later regarding a declared defect.

Any installation, maintenance, repair, service of the product performed by any person or entity other than seller without seller's prior written approval, or any use of replacement parts not supplied by seller, shall immediately void and cancel all warranties with respect to the affected product.

### Exercising the warranty

Once notified of a defect, the seller shall be responsible for remedying the defect at its own expense. The seller, however, reserves the right to modify the mechanisms of the equipment as needed to comply with its obligations.

The work to satisfy the warranty obligation shall be carried out, principally, in the seller's workshop after the buyer has returned the equipment or the defective parts to the seller for the purposes of repair or replacement, whichever the seller deems best.

However, if the nature of the equipment is such that the repair has to be carried out at the location where it was installed, the seller shall only be responsible for the on-site labor costs involved in direct service of the analyzer itself. The buyer is responsible for the cost of any additional measures needed to provide unrestricted access.

The cost of transport of the equipment or the defective parts, as well as the return of the repaired or replaced equipment or part, shall be borne by the buyer. In the case of on-site repair, the buyer shall be responsible for any travelling and accommodation expenses of the seller's representative.

Defective parts replaced free of charge, under warranty, must be returned to the seller and shall become its property once again.

---

## SUMMARY

<b>CHAPTER 0</b>	<b>SAFETY GUIDELINES</b>	
0.1	WARNING	0-10
0.2	REMINDER OF PRINCIPAL STATUTORY TECHNICAL PRECAUTIONS	0-11
0.3	PRESENTATION OF EQUIPMENT	0-12
0.4	RISKS ASSESSMENTS	0-14
0.5	RISK ANALYSES	0-15
0.6	RADIATION PROTECTION RECOMMENDATIONS	0-16
0.7	SAFETY INSTRUCTIONS - EXAMPLE	0-17
0.8	TECHNICAL CONTROLS OF RADIOPROTECTION	0-18
0.9	END OF LIFE OF THE ANALYZER	0-18
<b>CHAPTER 1</b>	<b>GENERAL – CHARACTERISTICS</b>	
1.1.	GENERAL	1-3
1.2.	CHARACTERISCS	1-13
<b>CHAPTER 2</b>	<b>PRINCIPLE OF OPERATION</b>	
2.1.	BETA GAUGE PRINCIPLE	2-3
2.2.	DEPOSITED MASS CALCULATION	2-4
2.3.	FLOW RATE REGULATION PRINCIPLE	2-6
2.4.	MEASUREMENT MODE	2-8
2.5.	« ZERO TEST » MODE	2-11
2.6.	TEMPERATURE REGULATED SAMPLING TUBE (RST)	2-11
<b>CHAPTER 3</b>	<b>OPERATION</b>	
3.1	INITIAL START-UP	3-4
3.2	PROGRAMMING THE MP101M	3-8
3.3	DESCRIPTION OF THE DIFFERENT SCREENS	3-11
<b>CHAPTER 4</b>	<b>PREVENTIVE MAINTENANCE</b>	
4.1.	SAFETY INSTRUCTIONS	4-2
4.2.	MAINTENANCE CALENDAR	4-3
4.3.	MAINTENANCE OPERATION SHEETS	4-3
4.4.	EQUIPMENT NECESSARY FOR MAINTENANCE	4-36
4.5.	SPARE PART LIST WITH PICTURES	4-38

**CHAPTER 5 CORRECTIVE MAINTENANCE**

5.1. LIST OF FAULTS AND CORRECTIVE ACTIONS	5-4
5.2. STATUS CODE LIST	5-12
5.3. GENERAL CONNECTION DIAGRAM	5-14

**LIST OF TABLES**

Table 3-1 – DB25 connector link	3-3
Table 3-2 – Measurement channel list	3-48
Table 5-1 – List of faults and correctives actions	5-4

**LIST OF FIGURES**

Figure 0-1 – Beta gauge source holder	0-12
Figure 0-2 – Radioactive clover	0-16
Figure 0-3 – Signaling label	0-17
Figure 1-1 – MP101M presentation	1-2
Figure 1-2 – Keyboard and display	1-4
Figure 1-3 – Front face, overview of collector assembly and beta gauge	1-5
Figure 1-4 – Rear panel	1-7
Figure 1-5 – Internal view of rear panel	1-7
Figure 1-6 – Flow regulation device	1-8
Figure 1-7 – Internal view	1-10
Figure 1-8 – Waterproof box	1-16
Figure 1-9 – Air-conditioned enclosure	1-17
Figure 1-10 – Mounting assembly for sampling gas/dust tube	1-20
Figure 1-11 – Picture and diagram of sampling lines	1-21
Figure 1-12 – RST line	1-22
Figure 1-13 – Links between units	1-23
Figure 1-14 – Outline dimensions	1-25



---

Figure 2-1 – General principle diagram	2-2
Figure 2-2 – Beta radiation gauge	2-3
Figure 2-3 – Flow rate control diagram	2-6
Figure 2-4 – Measurement management	2-9
Figure 2-5 – RST line assembly	2-14
Figure 3-1 – Fluid and electrical connections	3-4
Figure 3-2 – Menu and sub-menu tree	3-10
Figure 3-3 – Reference gauge insertion	3-24
Figure 3-4 – Putting in place the reference gauge	3-74
Figure 3-5 – View of Zero particle filter installed on analyzer inlet	3-80
Figure 4-1 – Diagram of the Picolino pump	4-5
Figure 4-2 – KNF pump diagram	4-6
Figure 4-3 – Cleaning of PM10 EN12341 and PM2.5 EN14907 sampling heads	4-9
Figure 4-4 – Cleaning of US-EPA standardized PM10 inlet	4-10
Figure 4-5 – Cleaning of US-EPA standardized VSCC™	4-11

## INDEX OF PAGES

Page	Date	Page	Date	Page	Date
0-1	09.2019	2-4	09.2018	3-41	09.2018
0-2	09.2018	2-5	09.2018	3-42	09.2018
0-3	09.2018	2-6	09.2018	3-43	09.2018
0-4	09.2018	2-7	09.2018	3-44	09.2018
0-5	09.2018	2-8	09.2018	3-45	09.2018
0-6	09.2018	2-9	09.2018	3-46	09.2018
0-7	09.2019	2-10	09.2018	3-47	09.2018
0-8	09.2018	2-11	09.2018	3-48	09.2018
0-9	09.2018	2-12	09.2018	3-49	09.2018
0-10	09.2018	2-13	06.2019	3-50	09.2018
0-11	09.2018	2-14	09.2018	3-51	09.2018
0-12	09.2018			3-52	09.2018
0-13	09.2018			3-53	09.2018
0-14	09.2018			3-54	09.2018
0-15	09.2018			3-55	09.2018
0-16	09.2018	3-1	09.2018	3-56	09.2018
0-17	09.2018	3-2	09.2018	3-57	09.2018
0-18	09.2018	3-3	09.2018	3-58	09.2018
		3-4	09.2018	3-59	09.2018
		3-5	09.2018	3-60	09.2018
		3-6	09.2018	3-61	09.2018
		3-7	09.2018	3-62	09.2018
		3-8	09.2018	3-63	09.2018
		3-9	09.2018	3-64	09.2018
		3-10	09.2018	3-65	09.2018
		3-11	09.2018	3-66	09.2018
		3-12	09.2018	3-67	09.2018
		3-13	09.2018	3-68	09.2018
		3-14	09.2018	3-69	09.2018
		3-15	09.2018	3-70	09.2018
		3-16	09.2018	3-71	09.2018
		3-17	09.2018	3-72	09.2018
		3-18	09.2018		
		3-19	09.2018		
		3-20	09.2018		
		3-21	09.2018		
		3-22	09.2018	4-1	09.2018
		3-23	09.2018	4-2	09.2018
		3-24	09.2018	4-3	09.2018
		3-25	09.2018	4-4	09.2018
		3-26	09.2018	4-5	09.2018
		3-27	09.2018	4-6	09.2018
		3-28	09.2018	4-7	09.2018
		3-29	09.2018	4-8	09.2018
		3-30	09.2018	4-9	09.2018
		3-31	09.2018	4-10	09.2018
		3-32	09.2018	4-11	09.2018
		3-33	09.2018	4-12	09.2018
		3-34	09.2018	4-13	09.2018
		3-35	09.2018	4-14	09.2018
		3-36	09.2018	4-15	09.2018
		3-37	09.2018	4-16	09.2018
		3-38	09.2018	4-17	09.2018
		3-39	09.2018	4-18	09.2018
		3-40	09.2018	4-19	09.2018
1-1	09.2018				
1-2	09.2018				
1-3	09.2018				
1-4	09.2018				
1-5	09.2018				
1-6	09.2018				
1-7	09.2018				
1-8	09.2018				
1-9	09.2018				
1-10	09.2018				
1-11	09.2018				
1-12	09.2018				
1-13	09.2018				
1-14	09.2018				
1-15	09.2018				
1-16	09.2018				
1-17	09.2018				
1-18	09.2018				
1-19	06.2019				
1-20	09.2018				
1-21	09.2018				
1-22	09.2018				
1-23	09.2019				
1-24	09.2018				
1-25	09.2018				
1-26	06.2019				
2-1	09.2018				
2-2	09.2018				
2-3	09.2018				

Page	Date	Page	Date
4-20	09.2018		
4-21	09.2018		
4-22	09.2018		
4-23	09.2018		
4-24	09.2018		
4-25	09.2018		
4-26	09.2018		
4-27	09.2018		
4-28	09.2018		
4-29	09.2018		
4-30	09.2018		
4-31	09.2018		
4-32	09.2018		
4-33	09.2018		
4-34	09.2018		
4-35	09.2018		
4-36	09.2018		
4-37	09.2018		
4-38	09.2018		
4-39	09.2018		
4-40	09.2018		
4-41	09.2018		
4-42	09.2018		
4-43	09.2018		
4-44	09.2018		
4-45	09.2018		
4-46	09.2018		

5-1	09.2018
5-2	09.2018
5-3	09.2018
5-4	09.2018
5-5	09.2018
5-6	09.2018
5-7	09.2018
5-8	09.2018
5-9	09.2018
5-10	09.2018
5-11	09.2018
5-12	09.2018
5-13	09.2018
5-14	09.2018
5-15	09.2018
5-16	09.2018
5-17	09.2018
5-18	09.2018

Page intentionally blank

**SAFETY GUIDELINES**

**THIS CHAPTER REFERS TO FRENCH REGULATIONS AND IS INCLUDED SOLELY FOR THE PURPOSE OF EXAMPLE AND INFORMATION.**

**FOR OPERATION OF THE ANALYZER OUTSIDE FRENCH TERRITORY, PLEASE REFER TO THE REGULATIONS IN FORCE FOR RADIATION PROTECTION IN THE COUNTRY IN WHICH IT IS TO BE USED.**

**RADIATION PROTECTION**

**SPECIAL INSTRUCTIONS**

**0.1 WARNING**

Radioactive sources are regulated substances, it means that their import, export, providing, transport, handling and elimination are managed by legislative texts: please, refer to local laws.

Equipment, process and work organization must be designed so that the individual and collective professional exposures are maintained as low as it is reasonably possible, below the limits prescribed by regulation

**SAFETY GUIDELINES****0.2 REMINDER OF PRINCIPAL STATUTORY TECHNICAL PRECAUTIONS**

In each establishment where this type of equipment is installed, the employer should designate a person responsible for the nuclear activity to make sure that radiation protection regulations are observed and applied.

This person must be aware of these instructions and draw up special instructions for employees who work with this equipment. A model of the safety measures to be exposed in the measurement system is shown at the end of this document, at paragraph 0.7.

The equipment and work methods and organization shall be designed such that individual or group exposure in a professional context shall be maintained as low as reasonably possible, below the limits defined by law.

Before the source is set into service, it should be inspected. Routine inspections of equipment and of the sealing of sources are also provided for in these regulations.

Each source must be delivered with a certificate from the manufacturer certifying the characteristics of the source, especially that it is a sealed source. A sealed source is a source whose structure is such as to prevent, under normal conditions of use, any dispersion of the radioactive substances into the environment.

When the sealed source is definitively removed from service, the end-user has to give the source to an authorized organism in his country. If there is no this kind of organism who deals with radioactive wastes, radioactive source shall be return to ENVEA, after having received a written agreement from ENVEA.

In case of loss or theft of an artificial radionuclide or in case of accident (fortuitous event causing a risk of radiation or contamination delivering an equivalent event dose greater than the equivalent of the maximum permissible dose), the authorized person must inform the government representative of the country where the event took place. Information has to be followed to ENVEA.



## SAFETY GUIDELINES

## 0.3 PRESENTATION OF EQUIPMENT

## 0.3.1 DESCRIPTION

The source is secured in the rotary cylinder which is integrated in the upper block of the Beta gauge.

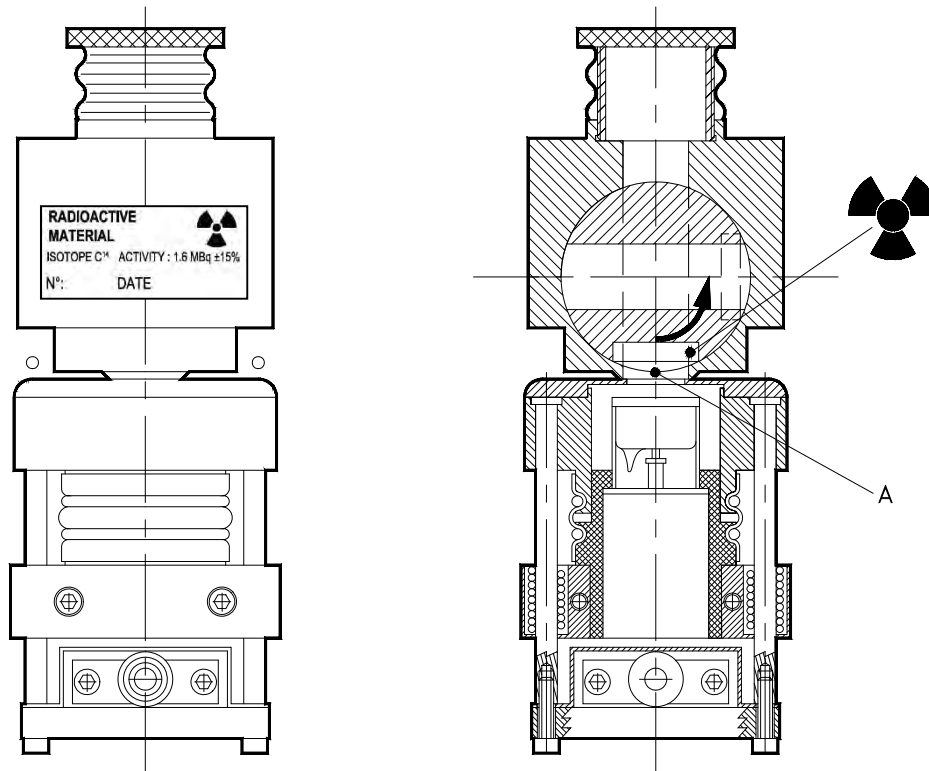


Figure 0-1 – Beta gauge source holder

A warning label is placed on the front side of the upper block of the receiver.

## 0.3.2 WARNING LABELS AND SAFETY DEVICES

The source holder is a rotary system. The Carbon 14 source can take two positions, storage and emission.

**In the emission position, do not touch exit window (A) with hand.**

The source holder cannot be disassembled. This design feature is intended to prevent easy access to the source. In the event of interruption of the measurement, source holder returns back automatically on storage position.

**SAFETY GUIDELINES****0.3.3 A RADIOACTIVE SOURCE**

Radio-element	Carbon 14
Shape	Sealed, classified C34343 under ISO2919 standards
Activity	1,6MBq+/-15%, means 1,84MBq maximum
Emission	Type $\beta$ - energy : 0,160 MeV
Period of the radioelement	5730 years



**SAFETY GUIDELINES****0.4 RISKS ASSESSMENTS**

The intensity of emission flow is the same one for each type of source used in the MP101M.

The risks assessment from external exposure is equivalent for the sources.

**0.4.1 MEASUREMENTS OF EXTREMITY DOSES**

Data are the following ones for Carbon 14 :

Dose rate measurement : Contact	$15 \pm 5$ mSv/h
Dose rate measurement : 10cm	$25 \pm 5$ $\mu$ Sv/h
Dose rate measurement in the plastic box	$1.3 \pm 0.3$ $\mu$ Sv/h
Dose rate measurement source into analyzer	0.1 $\mu$ Sv/h

There is no consideration of effective dose for the whole body because the emitted rays are absorbed after 23 cm.

**0.4.2 CONTROL OF NO CONTAMINATION**

The sources are sealed sources. A control of sealing characteristics and no contamination is carried out by the manufacturer and a certificate of sealed source is joined with each source.

The sources are compliant with ISO2919 classification, they respect C34343 classification



## SAFETY GUIDELINES

### 0.5 RISK ANALYSES

The maximum permissible dose for public laid down by French regulations are given in the here-below table. The values are extracted from the public health laws (Labour and Public Health Rules).

According to the French labour laws, a worker is told exposed if, because of his professional activity, he is submitted to ionizing radiations likely to involve doses superior to the levels presented here-below.

Exposed zone	Limit of equivalent dose
Global exposure	1 mSv/ year
Crystalline lens	15 mSv/ year
Skin	50 mSv/ year in average value for any surface of 1cm <sup>2</sup>

#### 0.5.1 EXTERNAL EXPOSURE

When the analyzer is working, and even when the analyzer is not working, there is no direct access to the source. Under normal conditions of analyzers use, there is no possible irradiation. Indeed, because of the radiation type, there is no possible external exposure for the whole body (radiations have a distance lower than 23cm).

Consequently, the sources handling only occur when the source is put in place into the analyzer, and when the source is put out of the analyzer at the end of the source use.

The sources handling can only be carried out by people qualified and trained to this kind of sources and to their specific dangers. The technician must wear gloves.

For hands, in contact with the window of measurement, we can consider a dose rate of 0, 1 $\mu$ Sv/h. To exceed the regulatory threshold of 50000 $\mu$ Sv per year, the technician should leave his hands in contact with the window of measurement of the analyzer during more than 500 000 hours per year, which is realistic. Therefore, the values are very much lower than flows of tolerable for the public.

NOTA : to value the received dose, the dosimetric films are inoperative because insensitive to Beta radiations of low energy.

#### 0.5.2 INTERNAL EXPOSURE

The internal exposure corresponds to the ingestion or the inhalation of radioactive materials.

According to the appendices of directive Euratom 96/29, the effective dose engaged by ingestion for the <sup>14</sup>C is 5,8.10<sup>-10</sup> Sv/Bq. To exceed the threshold of 1 mSv/an (total exposure), it would be necessary to eat one <sup>14</sup>C source per year (for source of 1,6MBq)

These situations are obviously completely improbable. In normal condition of use the probability of inhaling radioactive dusts is very low: the sources are sealed into a closed analyzer.

An assessment by French Radioprotection Expert, IRSN, was made, they confirmed that the level of internal exposure is considered negligible and radiation doses are well below regulatory limits.

**In normal use, the personnel, using MP101M, is not defined as exposed worker, and is not classified into category A or B. The acceptable exposure values are those valid for the public.**

In practice, there is neither protected area (it would be located in contact with the outlet window which is inaccessible), nor controlled area.



## SAFETY GUIDELINES

### 0.6 RADIATION PROTECTION RECOMMENDATIONS

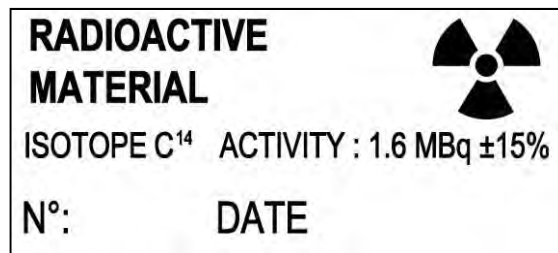
#### 0.6.1 SIGNALS

A label indicating the presence of a radioactive source can be put outside on the analyzer door. In this case, it is necessary to use the black radioactive clover on yellow background. To take care not to use other types of clover.



Figure 0-2 – Radioactive clover

A warning label is placed on the front side of the upper block of the receiver.



#### 0.6.2 STAFF INFORMATION

The staff of the user company should be clearly informed of the presence of the radioactive source, of the associated risks, and of the meaning of various signals.

#### 0.6.3 INTERVENTION ON SOURCE HOLDERS

Any intervention on source holders should be made by the supplier or under the authority of the person responsible for the nuclear activity of the user company by an person aware of the risks.

#### 0.6.4 ESTIMATES OF SPECIAL RISKS

The person responsible for the nuclear activity should draw up the miscellaneous instructions to be applied in case of malfunctions, incidents or fires, providing for the measures to be taken and the interventions to be carried out.

In case of a fire likely to affect the confinement of the sealed source, the risk of surface and atmospheric contamination would be low in light of the activity applicable in this case.



## SAFETY GUIDELINES

### 0.7 SAFETY INSTRUCTIONS - EXAMPLE

# SAFETY INSTRUCTIONS

This analyzer contains a radioactive source of Carbon-14, activity 1.6 MBq+/-15%  
 THE EMISSION HEAD containing the source is sealed by special screws

The presence of source is indicated by the following label :

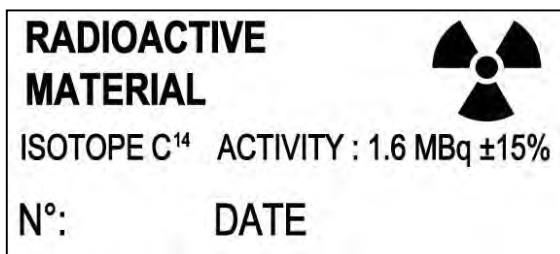


Figure 0-3 – Signaling label

*NB : The date mentioned is the date of source calibration.*

**IT IS FORBIDDEN TO OPEN THE SOURCE HOLDER.  
 IT IS FORBIDDEN TO SEPARATE THE SOURCE FROM THE SOURCE HOLDER.  
 THERE IS A RISK OF RADIATION ON CONTACT OF OUTLET WINDOW.  
 DO NOT EXPOSE HANDS TO THIS LOCATION.**

**Any malfunction or deterioration found on the measurement system must immediately be made known to the person responsible for the nuclear activity:**

Name : .....Tel : .....

Labour physician:  
 Name:..... Tel : .....

Address: .....

**SAFETY GUIDELINES****0.8 TECHNICAL CONTROLS OF RADIOPROTECTION**

ENVEA recommends to the users of the analyzers containing a radioactive source, to periodically carry out the technical checking of radioprotection, in particular:

- Monthly checks, using, for instance, the Contamination Test described in the technical manual of the analyzer.
- Periodic radioprotection checks according to the regulation in-force in the country where the analyzer is used.

**0.9 END OF LIFE OF THE ANALYZER**

Refer to your local rules about end of life of radioactive material and electrical and electronic equipments.

## CHAPTER 1

### GENERAL – CHARACTERISTICS

<b>1.1. GENERAL</b>	<b>1–3</b>
<b>1.1.1. PRESENTATION (FIGURE 1–1)</b>	<b>1–3</b>
<b>1.1.2. DESCRIPTION</b>	<b>1–4</b>
1.1.2.1. Front face	1–4
1.1.2.2. Rear panel	1–9
1.1.2.3. Internal view	1–11
<b>1.1.3. ASSOCIATED EQUIPMENT</b>	<b>1–12</b>
1.1.3.1. Sampling assembly	1–12
1.1.3.2. Pump assembly	1–12
1.1.3.3. Automatic calibration option	1–12
<b>1.2. CHARACTERISTICS</b>	<b>1–13</b>
<b>1.2.1. TECHNICAL CHARACTERISTICS</b>	<b>1–13</b>
<b>1.2.2. OPERATING CHARACTERISTICS</b>	<b>1–14</b>
<b>1.2.3. STORAGE CHARACTERISTICS</b>	<b>1–14</b>
<b>1.2.4. INSTALLATION CHARACTERISTICS</b>	<b>1–15</b>
1.2.4.1. Composition	1–15
1.2.4.2. Installation	1–18
1.2.4.3. Links between units	1–23
1.2.4.4. Dimension and weight (Figure 1–14)	1–23
1.2.4.5. Handling and storage	1–23
<b>1.2.5. CERTIFICATIONS</b>	<b>1–26</b>
1.2.5.1. USEPA designation: PM10 (EQPM – 0404 – 151), PM2.5 (EQPM – 1013 – 211)	1–26
1.2.5.2. European Designation	1–26
Figure 1–1 – MP101M presentation	1–2
Figure 1–2 – Keyboard and display	1–4
Figure 1–3 – Front face, overview of collector assembly and beta gauge	1–5
Figure 1–4 – Rear panel	1–7
Figure 1–5 – Internal view of rear panel	1–7
Figure 1–6 – Flow regulation device	1–8
Figure 1–7 – Internal view	1–10
Figure 1–8 – Waterproof box	1–16
Figure 1–9 – Air-conditioned enclosure	1–17
Figure 1–10 – Mounting assembly for sampling gas/dust tube	1–20
Figure 1–11 – Picture and diagram of sampling lines	1–21
Figure 1–12 – RST line	1–22
Figure 1–13 – Links between units	1–23
Figure 1–14 – Outline dimensions	1–25

## 1. GENERAL – CHARACTERISTICS

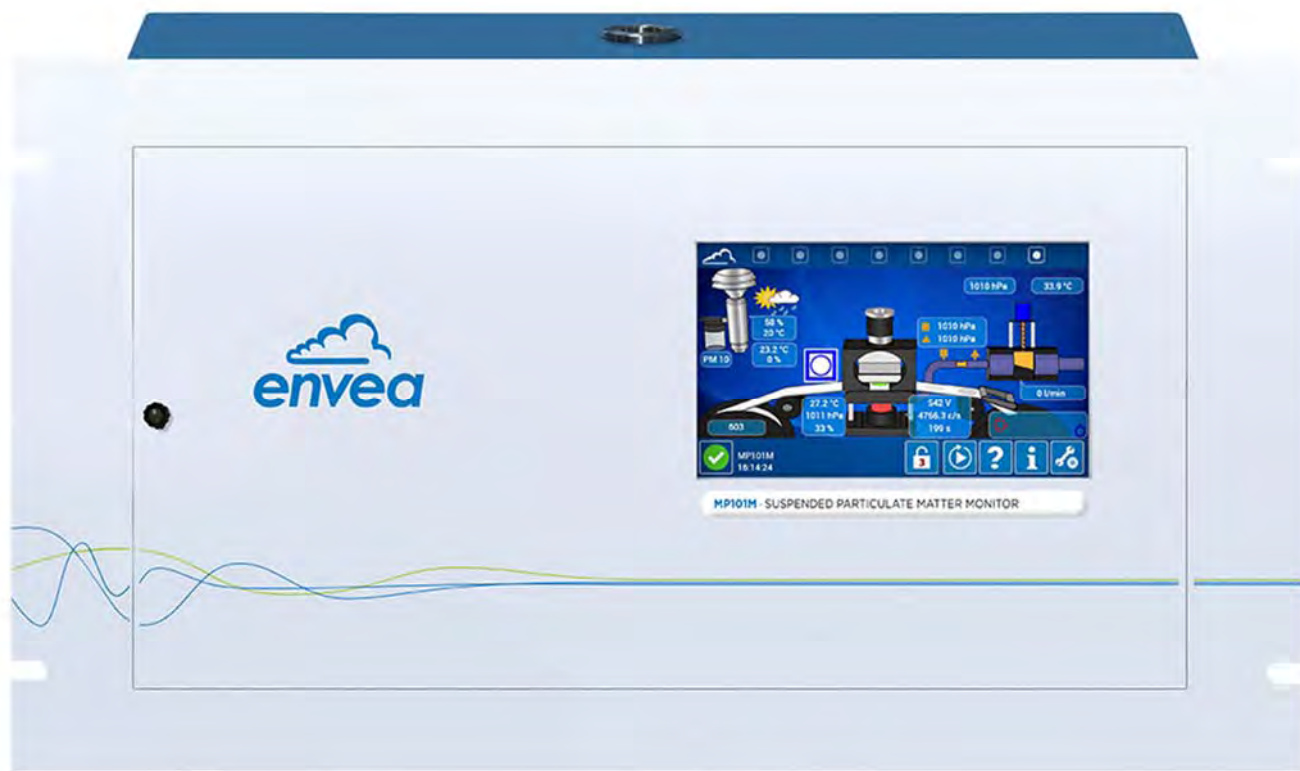


Figure 1-1 – MP101M presentation

## 1.1. GENERAL

### 1.1.1. PRESENTATION (FIGURE 1-1)

The MP101M is used to measure suspended particulate in the ambient air. It allows regulatory monitoring of PM10 and PM2.5:

- PM10 represents the particle category whose diameter is lower than 10 µm (respirable suspended particulates).
- PM2.5 has a diameter lower than 2.5 µm. These particles progress deeper in the respiratory system.

In addition, the MP101M allows the continuous monitoring of relative changes in the natural radioactivity of the sampled dust, with an alarm activation in case of threshold exceeding.

It can be installed in indoor cabinet, for setting up in a closed room, or in outdoor cabinet with an air-conditioning system.

Its technical principle is based on the particle measurement by beta radiation attenuation. The suspended particles are collected with a determined volume aspiration on a fiber-glass filter. The filter has an automatic sequential movement.

The measurement principle is based on the beta ray absorption increase with the sample surface density. When determining the mass of the collected particles on the filter, the source faces the particle deposit and the Geiger-Müller counter. Then, the measurement consists in calculating the absorption difference between a blank filter and a loaded filter, knowing that the beta ray absorption follows an exponential law and is independent of the physicochemical nature of the particles.

The Carbon-14 (<sup>14</sup>C) radioelement contained in the source is of low activity and has a long life-time (≈ 5730 years).

The filter ribbon allows a great number of samplings (1200), i.e. three years of continuous operation.

By the high-reliability of its components and its ease of use, the MP101M requires very limited maintenance.



## 1.1.2. DESCRIPTION

### 1.1.2.1. Front face

Refer to Figure 1–1 and Figure 1–3.

The front panel of the analyzer consists of a fixed part and a movable door giving access to the collector assembly and Beta gauge.

The door swivels left-to-right on its axis and is locked by a quarter-turn button located on the left side.

The front panel includes the following: (Figure 1–1)

- Backlit color TFT LCD (Thin Film Transistor Liquid Crystal Display):
  - Resolution of 800 x 480 (pixels), 7" screen,
  - The display provides the measurement values and other system parameters, as desired.
- Interactive touch screen.
- USB port used for software updating, system restoration with a previous software version and data storage.

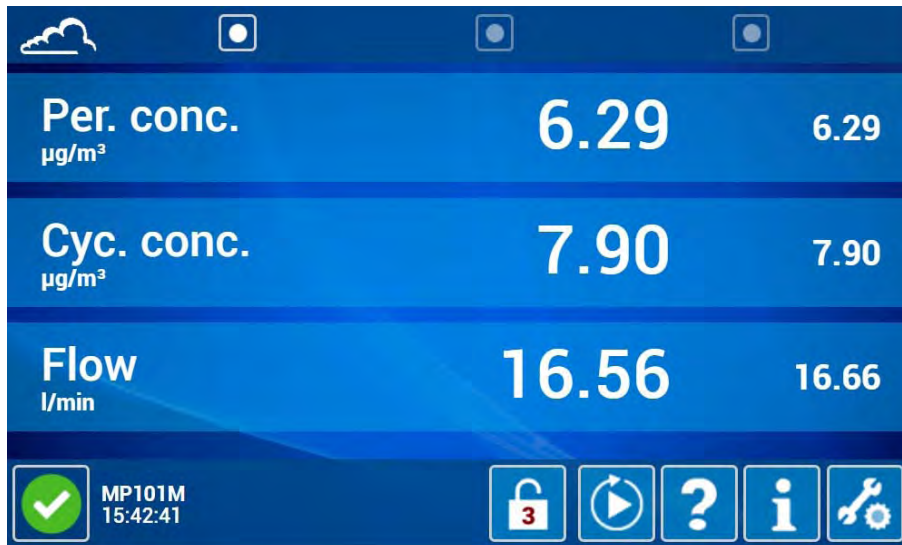
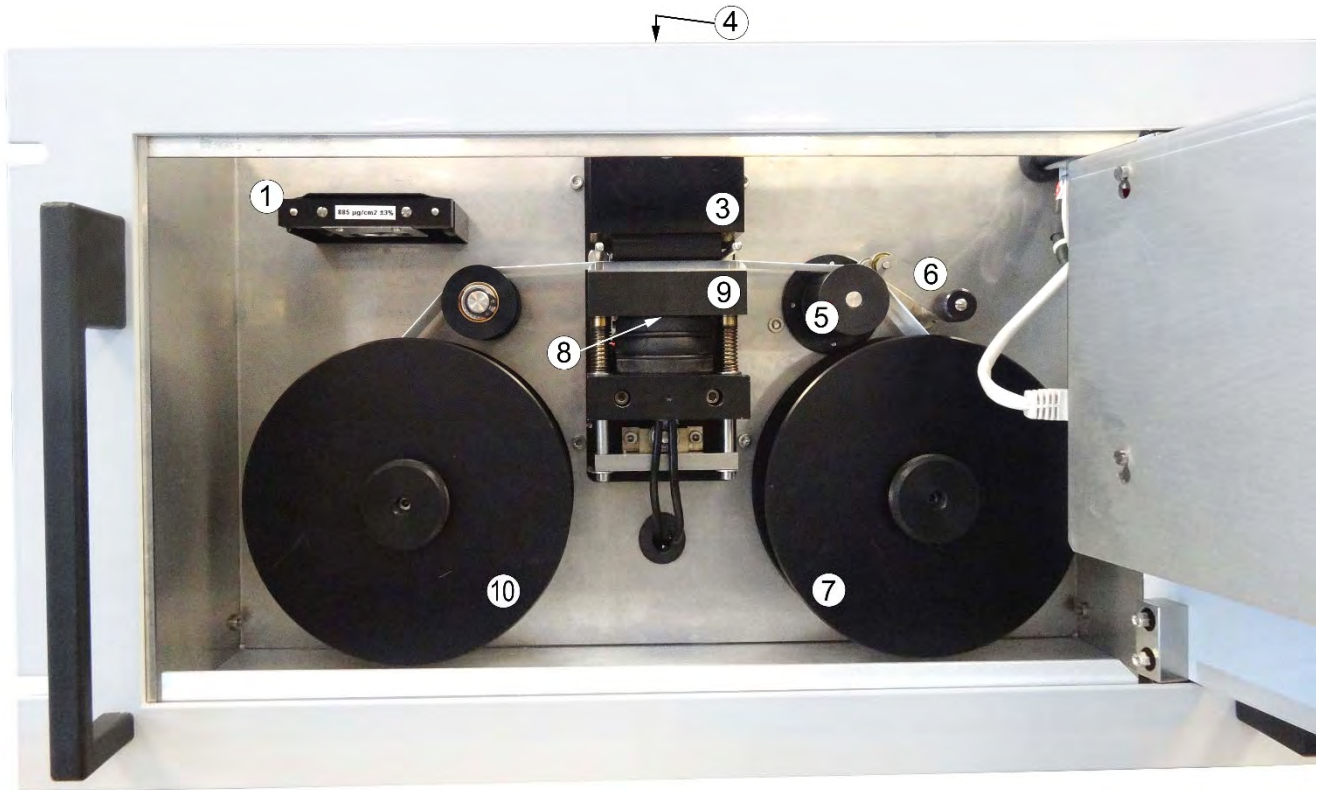


Figure 1–2 – Color touch screen



(1) reference gauge, (3) source holder, (4) retractable tip on sample inlet, (5) capstan, (6) pinch roller, (7) take-up reel, (8) Geiger-Müller detector tube, (9) plate assembly, (10) pay-out reel.

**Figure 1-3 – Front face, overview of collector assembly and beta gauge**

**Door open (Figure 1–3):**

The door is opened by turning the locking button clockwise. Then, the following components are accessible:

- The reference gauge (1) :
  - The reference gauge is located in a specific dust-proof housing.
  - Its surface mass is determined in laboratory by gravimetric weighing.
  - The reference gauge is used for calibrating and checking the Beta gauge manually, if the automatic calibration option is not installed in the analyzer.
- The filter ribbon driving system:
  - a pay-out reel (10),
  - a take-up reel (7),
  - a capstan (5) coupled to the synchronous feed motor,
  - a disengageable pinch roller (6).
- The Beta gauge :

It consists of a Carbon-14 radioactive source ( $^{14}\text{C}$ ), located in a source holder (3) where the source can take two positions:

  - On the right side, in sampling or stop,
  - Facing the Geiger counter, in measurement.
- Located on this same axis, downstream the ribbon, a Geiger-Müller tube detector (8).

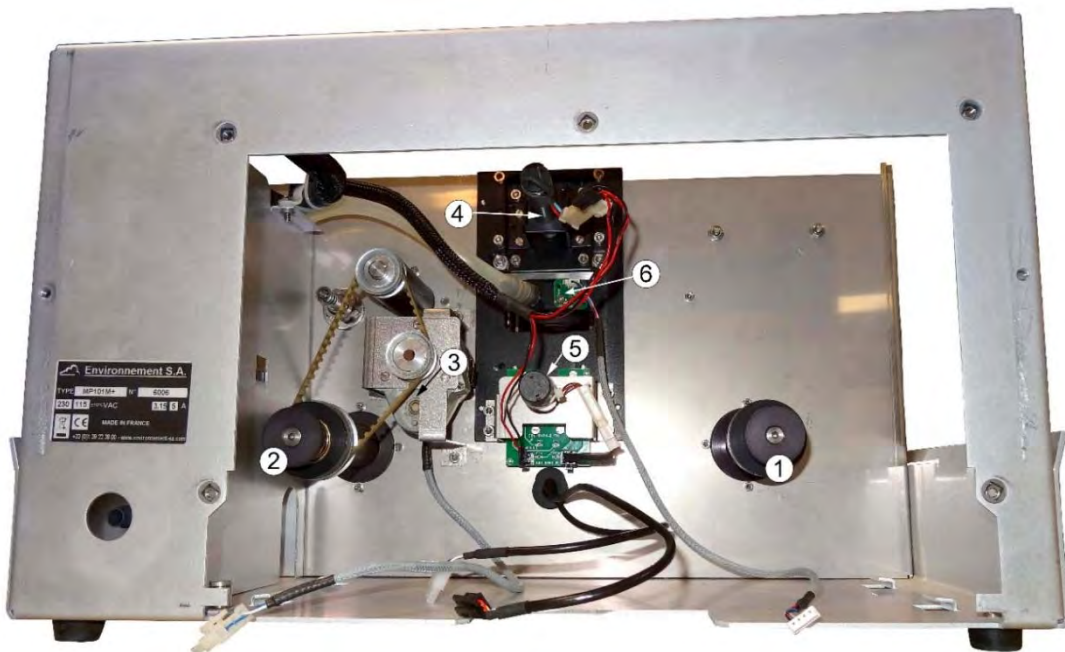
In measurement mode, the source and G.M counter always maintain their same relative positions whatever the operations performed on the analyzer (translation of plate assembly, ribbon movement, reference gauge setting-up) in order to ensure the same counting conditions in all cases.

- The aeraulic device :
  - A retractable tip (4) allows connection between the sampling line and the MP101M.
  - An additional tightness part is used to keep tightness between the retractable tip and the RST line in case of vertical line moving by a distance less than 2 cm (example : shelter roof deformation).
- The stainless steel sampling line channels the gas sample up to the glass fiber filter (filter ribbon) without obstacle, thus ensuring homogeneity of the particle deposit.
- The device tightness at filter level is ensured by the plate assembly (9) holding, in measurement mode, the filter between the source block and an holding grid located above the GM counter.



(1) general fuse F1 and mains power supply block, (2) fan, (3) TUCHEL connector for tube heating, (4) RS232/RS422 socket, (5) external pump supply, (6) external temperature and humidity sensors, (7) TCP/IP socket, (8) pump outlet, (9) holding cover screws, (10) ESTEL board options, (11) connection socket to CPM option, (12) holding screws of the rear panel drawer.

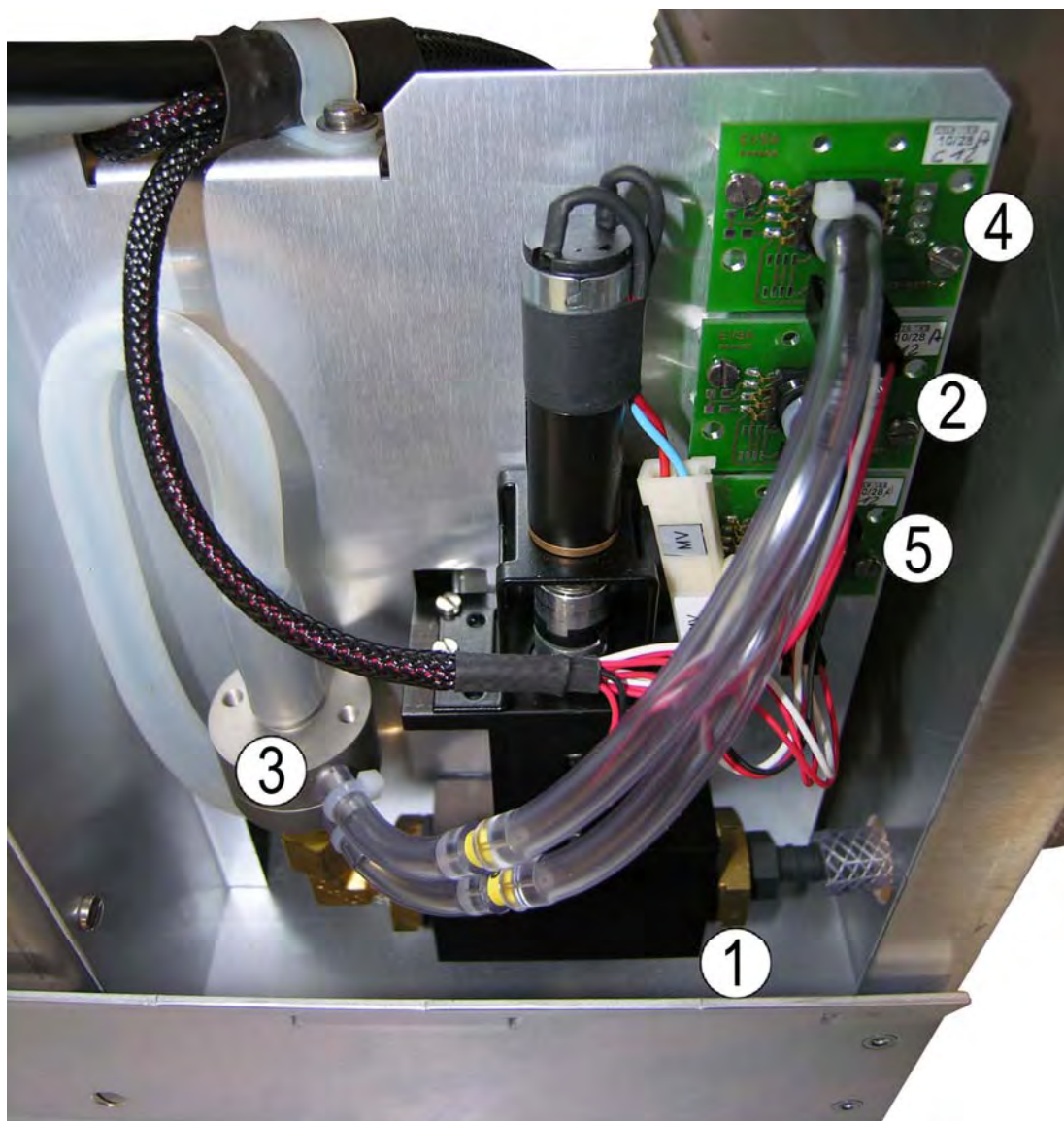
**Figure 1-4 – Rear panel**



(1) Pay-out reel axis, (2) Take-up reel axis, (3) paper motor, (4) rotation motor of the source-holder, (5) plate motor, (6) GM sensor board.

**Figure 1-5 – Internal view of rear panel**





(1) motor-driven valve, (2) downstream pressure sensor P2, (3) flat orifice, (4) upstream pressure sensor P1, (5) atmospheric pressure sensor (atm. P.).

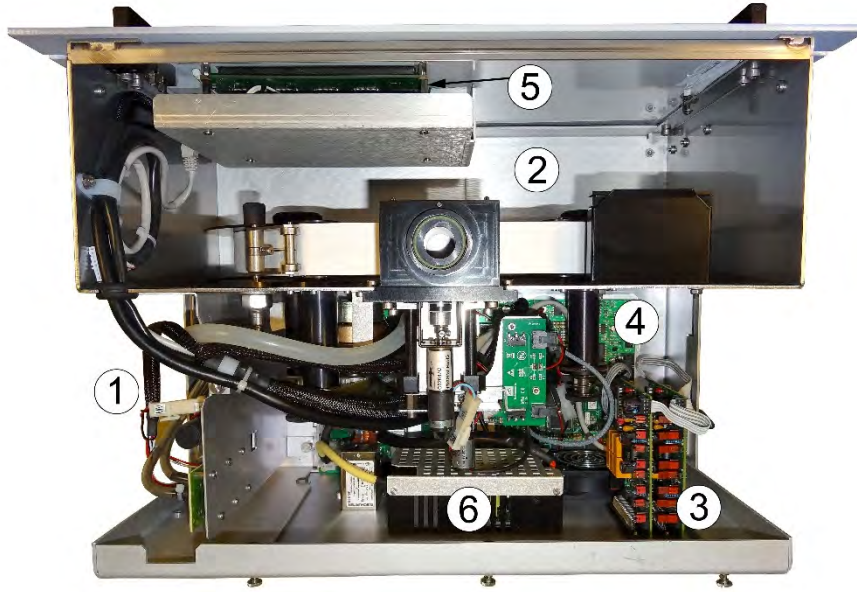
**Figure 1-6 – Flow regulation device**

**1.1.2.2. Rear panel**

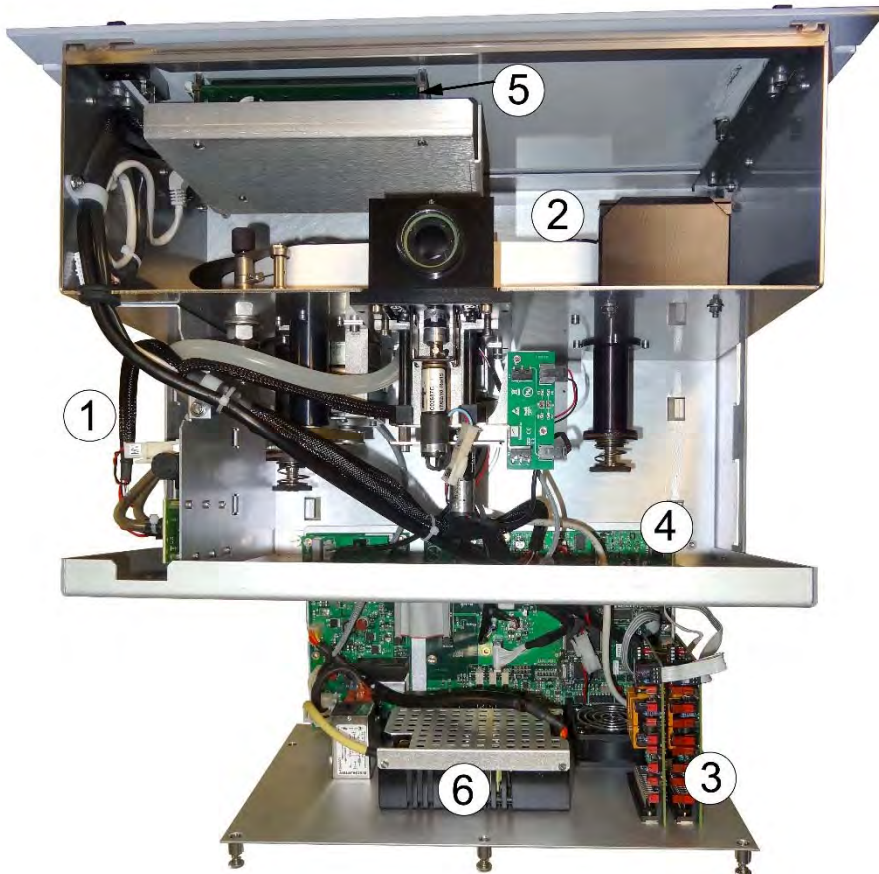
Refer to Figure 1–4

The MP101M rear panel contains all the electrical connection sockets and the air outlet connector. It is designed as a drawer containing various mechanical elements on its internal part.

- Air outlet (bottom left side)
  - The "pump outlet", to be connected to the external vacuum pump, consists of an 8 mm diameter straight end piece (8).
  
- Electrical equipment and connections
  - The mains power supply block, consisting of the general switch, a 3-contact socket for a standard power cable connection, includes two time-delay fuses of 3.15 A / 230 V or 5 A / 115 V (1).
  - One 25-pin connector for the serial link (RS232/RS422) (4).
  - One 3-contact TUCHEL connector for 24 V CC supply of the sampling tube heating (3).
  - One external pump power supply connector (5).
  - One 15-pin socket for link with the ambient air meteorological sensors (6),
  - One TCP/IP network socket (7).
  - One socket for CPM link (11).
  
- Ventilation system
  - The ventilation system consists of an integrated fan in the rear panel (2). It allows correct ventilation of the electrical and electronic circuits.



View with rear drawer closed



View with rear drawer open

(1) flow regulation part, (2) beta gauge and collector assembly, (3) electronics part, (4) Module board, (5) ARM20 board, (6) power supply block.

Figure 1-7 – Internal view

### 1.1.2.3. Internal view

Refer to Figure 1–7

The components inside the analyzer are accessed by simply unscrewing the knurled screws (Rep. 9, Figure 1–4) and removing the upper cover.

The framework is divided into three parts, separated by two aluminum plates:

- The collector assembly and the Beta gauge in front of the analyzer (refer to Figure 1–3 and paragraph 1.1.2.1),
  - The sampling flow regulation part (on the right),
  - The electronics part.
- The flow rate control part (Figure 1–6)

The essential components are:

- A motor-driven valve (1),
  - A flat orifice block (3).  
The hydrostatic pressure drop observed in passing the constriction in the fluid circuit is used to deduce the flow speed and the flow rate.
  - Three pressure sensors upstream and downstream of the flat orifice: P1 (4), P2 (2) and atm. P. (5) not linked to the fluid circuit.
- The electronics part
- It consists of a module board (4) and high and low voltage supply boards (6). These boards are fixed on a sliding drawer which can be pulled outwards the framework for a quick access when maintenance is necessary.



### 1.1.3. ASSOCIATED EQUIPMENT

- Sampling assembly,
- Pump assembly,
- Automatic calibration option.

#### 1.1.3.1. Sampling assembly

It consists of:

- A standard interchangeable sampling head according to application:
  - TSP,
  - PM10 USEPA or EN12341
  - PM2,5 USEPA or EN14907
  - PM1
- A regulated sampling tube (RST) made of stainless steel, including :
  - A heating ribbon twisted around the aspiration line,
  - A stainless steel tube, 60 mm diameter, protecting the aspiration line,
  - Two fastening flanges and a gasket to ensure tightness from outside,
  - A meteo sensor consisting of a temperature probe and a humidity probe.The RST line is available in many lengths: 1 m; 1.50 m; 2 m; 2.75 m or more with specific study.

#### 1.1.3.2. Pump assembly

It consists of a pump and a connecting tube.

#### 1.1.3.3. Automatic calibration option

This option is used to carry out calibrations, mass tests and gauge tests at user-configurable frequencies.

It consists of:

- A span film made of Mylar (identical to the manual reference gauge film),
- An electronics board with two position sensors and a motor allowing to automatically place the span film between the filter holder assembly and the moving plate.

The assembly is compatible with the whole analyzers MP101M whose serial number is > 3000.

**1.2. CHARACTERISTICS****1.2.1. TECHNICAL CHARACTERISTICS**

Measurement principle	: Beta ray attenuation measurement
Type of measurement and units	: Concentration in $\mu\text{g}/\text{m}^3$ (PM10, PM2.5, PM1, TSP, according to the sampling head used).
Flow units	: $\text{l}/\text{mn}$ , $\text{m}^3/\text{h}$
Volume units	: litres, $\text{m}^3$ , $\text{Nm}^3$ , $\text{Sm}^3$ (at 20°C and at 25°C)
Result form of concentration measurements	: – Cyclic – Periodic – Average – Floating average
Geiger-Müller counting time	: 260 sec. by default (can be modified)
Measurement periods	: 10 mn, 1/4 - 1/2 - 1 - 2 - 3 - 4 - 6 - 12 - 24 - 48 hours (recommended values: 1h or 2h).
Measurement cycles	: 1 - 2 - 3 - 4 - 6 - 12 - 24 - 48 - 72 - 96 hours (recommended value: 24 h)
Zero level and detection limit	: $\leq 2 \mu\text{g}/\text{m}^3$ (24h averages)
Measurement accuracy (i.e. uncertainties between analyzers)	: $\leq 2.5 \mu\text{g}/\text{m}^3$ (24h averages)
Flow accuracy	: $\leq 2\%$ of nominal flow
Beta source	: Carbone-14 radioelement, 1.6 MBq activity Radioelement life time $\approx 5730$ years
Calibration	: by manual or automatic reference gauge.
Aspiration flow	: $1 \text{ m}^3/\text{h}$
Standard filter ribbon	: Ribbon, width: 35 mm and length: 30 meters Glass fiber filter
Autonomy	: 1200 samples, i.e. more than 3 years for one spot per 24 hours
External pump	: Vacuum pump with two flat diaphragm heads, or impeller pump
Display	: Color touch screen

---

Output signals	:	up to 8 analog outputs (programmable full scale) 0-1 V, 0-10 V, 0-20 mA, or 4-20 mA with optional galvanic isolator (depends on the ESTEL board option number)
Power supply	:	230 V-50 Hz (115 V-60 Hz on request) + ground
Consumption	:	Maximum, when starting = 200 W Average, after 24 hours = 180 W
Use temperature	:	+ 10 °C to + 40 °C
Alarm check	:	– Permanent – Detection and indication of malfunctions: temperature, pressure, flow rates, electric parameters
Tests and diagnostics for maintenance	:	on display.
Back-up saving time for stored data in FLASH and real-time clock	:	unlimited 2 years by built-in battery

### 1.2.2. OPERATING CHARACTERISTICS

Refer to Safety Guidelines CS1 to CS9.

### 1.2.3. STORAGE CHARACTERISTICS

- Temperature: – 10 °C to 60 °C.
- The Carbon-14 source must be in storage position during analyzer transport.

**1.2.4. INSTALLATION CHARACTERISTICS**

The MP101M can be incorporated into a standard cabinet for indoor installation, in a waterproof box or an air-conditioned cabinet for outdoor installation.

**1.2.4.1. Composition**a) MP101M standard cabinet

This is a standard 19-inch cabinet designed to receive 32 "deep" units (useful depth = 750 mm).

The cabinet includes:

- 1 sliding panel,
- 1 pump drawer,
- 4 fans (upper part),
- 1 tangential fan (lower part),
- 1 differential circuit breaker equipped with 5 electrical distribution connectors,
- 1 power supply terminal block with fuse holder,
- 1 connection terminal block (inputs/outputs, analog signals),
- 1 rear door with key lock.

**Option:** Glazed front door with key lock.

b) MP101M EX waterproof box

This is a wired polyester box designed to protect the MP101M and its sub-assemblies against bad weather (IP 559 protection, C20010 NF standard).

It includes:

- 1 inner bottom plate, made of aluminum
- 1 fixing pump plate,
- 2 lateral fans,
- 2 air ports,
- 1 heating system with thermostat.
- 1 differential circuit breaker equipped with 4 electrical distribution connectors,
- 1 power supply terminal block with fuse holder,
- 1 connection terminal block (inputs/outputs and analog signals)
- 1 front door,
- 1 rear door,

**NOTE:** The doors are closed by a 3-point casement bolt, locked by a handle with key lock.

- 1 external stainless steel strengthening piece for the sampling head,
- 2 stainless steel feet for cabinet fixation.

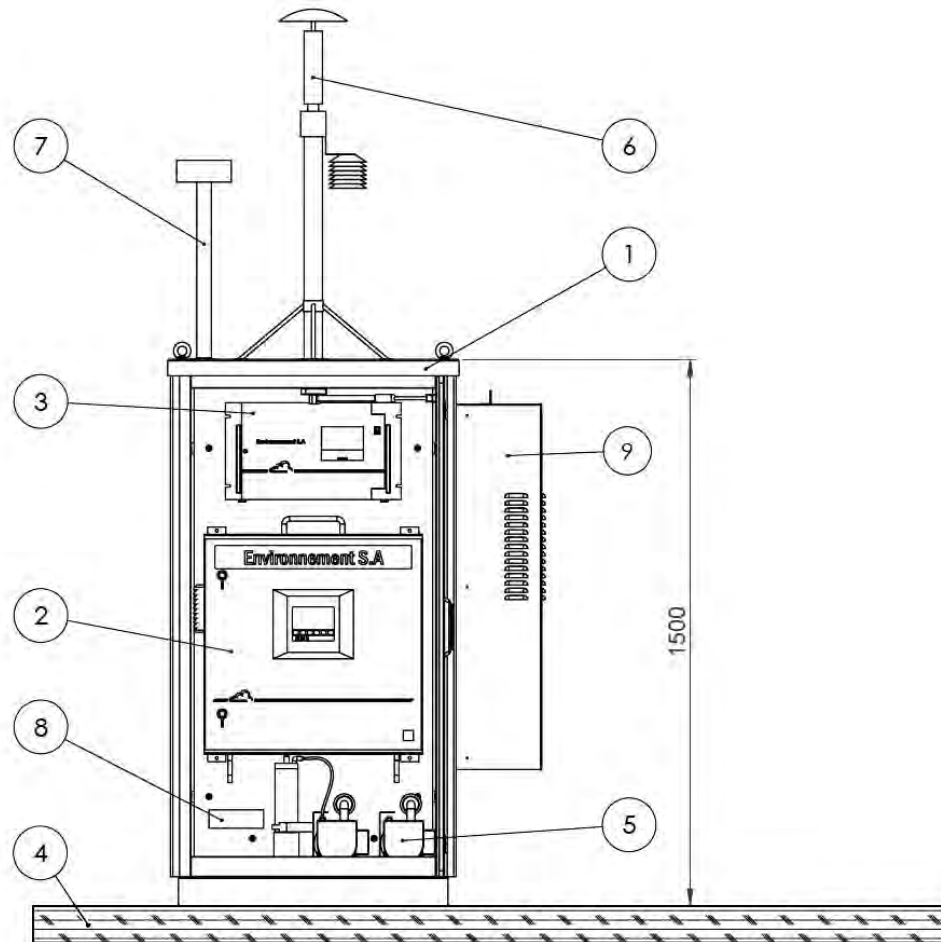
**Heating system**

The waterproof box heating is provided by a 500 W electrical resistance coupled to one of the fans. Temperature is controlled by a thermostat (range: 0 to 30 °C) associated to a safety switch (outage at 60 °C).

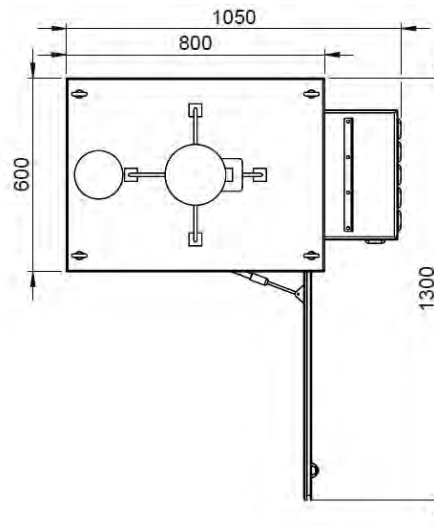


Figure 1–8 – Waterproof box

c) Air conditioned enclosure available on request.



Front view



Above view

(1) Enclosure – dimensions: 800 mm x 600 mm x 1500 mm, (2) MMS, (3) MP101LCD, (4) concrete base, (5) pump assembly, (6) sampling particle tube, (7) sampling gas head, (8) electrical connection block, (9) air-conditioner.

**Figure 1-9 – Air-conditioned enclosure**

### 1.2.4.2. Installation

#### a) Installation

##### a.1) *Concrete base for outdoor cabinet*

For fixing the waterproof box, it is necessary to provide a concrete base, dimensions: 2 m x 1 m.

The minimum base height depends on ground conditions (out-of-water setting).

A free passage is to be provided in this base for the electrical power cable, and the other cables for remote-control, telephone line, et c..

Four threaded rods,  $\varnothing$  M 10, exceeding 0.10 m, must be sealed in the concrete to receive the stainless steel feet on which the cabinet stands.

##### a.2) *Installation in a shelter or a building.*

When the MP101M place is selected, a competent person will have to drill a passage (hole) in the shelter ceiling, vertically to the analyzer inlet, in order to put in place the sampling tube.

**IMPORTANT: ROOF TIGHTNESS AROUND THE PASSAGE (HOLE) HAVE TO BE DONE VERY CAREFULLY, TO AVOID LEAKS DAMAGE THE ANALYZER.**

The two fastening flanges and the tightness gasket provided with the sampling tube must be used for installation.

##### a.3) *MP101M installation*

The MP101M has to be placed on the upper cabinet shelf, and it is blocked by inserting the analyzer rear feet in the holes designed for this purpose.

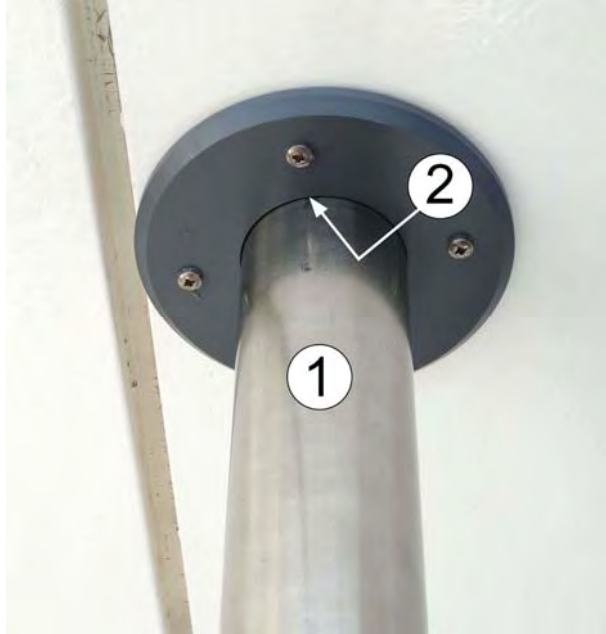
The MP101M may also be placed on a table or a cabinet plate provided for this purpose.

**WARNING: When installing, it is necessary to let a free space behind the analyzer for the connections.**

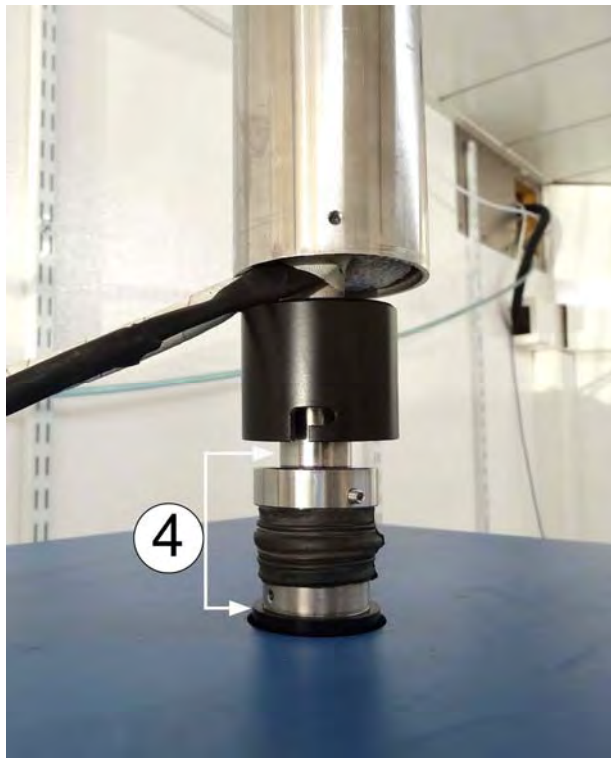
a.4) *Sampling line installation and electrical connections*

**REMARK :** It is recommended to install a 60mm-diameter nitrile rubber insulating pipe (not supplied) around the external tube of the RST line, on the part inside the room.

A) Position the sampling line (1) in the hole (2). Adjust the line height in order to ensure tightness between the line (1) and the MP101M (3).

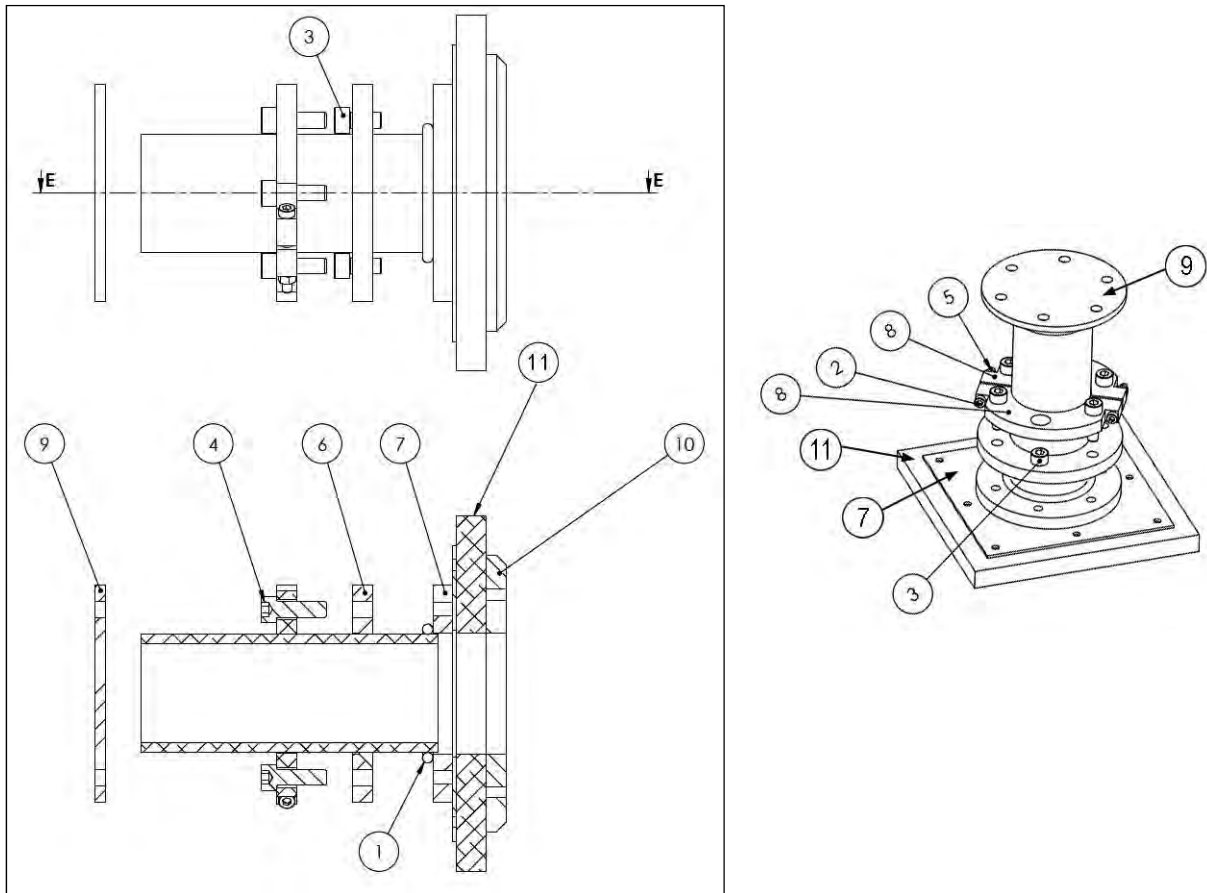


B) The sampling line must not squeeze the retractable tip (4) screwed on the MP101M sampling inlet. The retractable tip must remain flexible (5) to free the MP101M (3) from the line without dismounting the line.



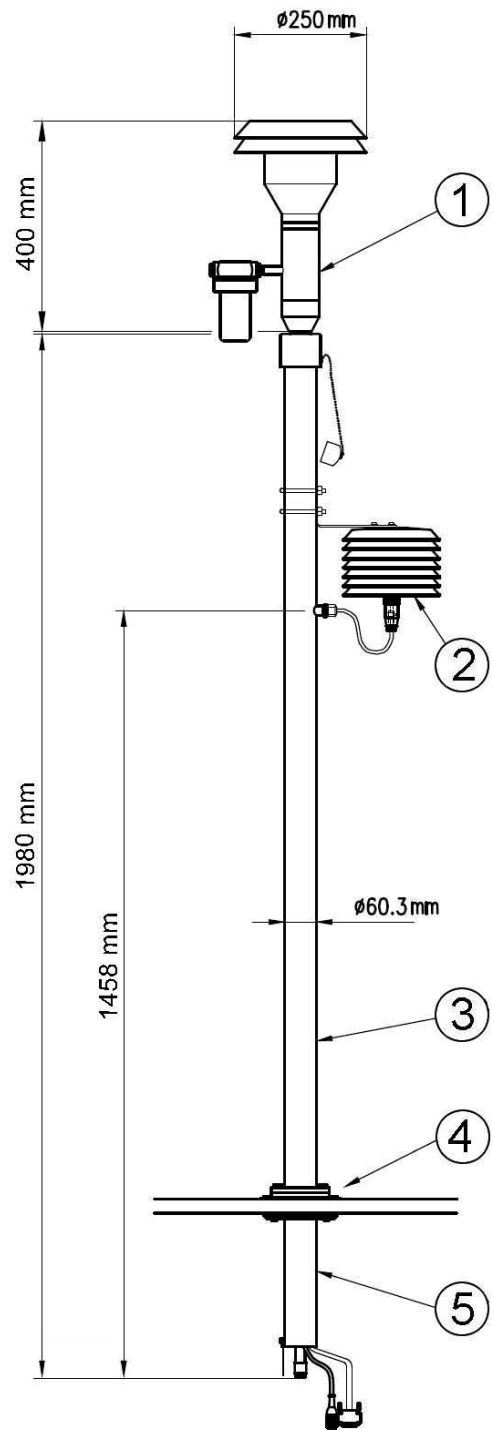


C) Then block the sampling line with the flanges provided for this purpose (external flange + internal flange).



(1) O ring, (2) (3) (4) screws, (5) nut, (6) roof counter-flange, (7) roof flange, (8) clamping half-ring, (9) stopper plate for dust head flange, (10) hub cap of dust/gas head, (11) roof (shown for information).

**Figure 1-10 – Mounting assembly for sampling gas/dust tube**



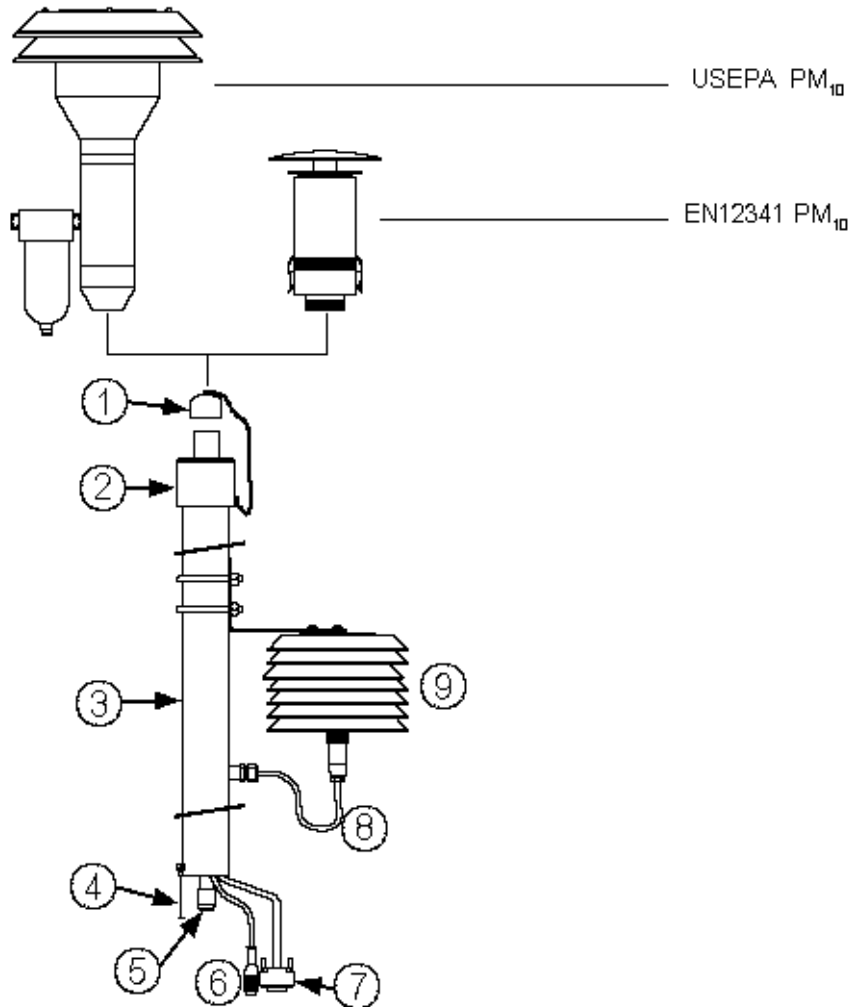
(1) PM10 sampling-dust head, (2) temperature and humidity sensor, (3) RST sampling line, (4) refer to Figure 1-10, (5) line part inside the room or the enclosure.

**Figure 1-11 – Picture and diagram of sampling lines**

D) Fix the meteorological sensor protection (9) on the external part of the RST line and connect it with the cable (8). Connect the tube heating cable (6) to the socket marked « tube heating » on the analyzer rear panel. Connect the 15-pin connector (7) to the socket marked « T/HR sensor » on the analyzer rear panel.

Connect the sampling line to ground using the ground wire (4).

E) Remove the stopper (1), then install the sampling head on the RST line. For European sampling head types, it is recommended to apply a thin grease layer on the inner cupel. Refer to chapter 4, Preventive maintenance.



(1) protection stopper for storage, (2) adapter for standard sampling head, (3) external tube – diam. 60 mm, (4) ground wire, (5) sampling tube, (6) head heating cable, (7) temperature and humidity sensor cable, (8) cable to the meteorological sensor protection, (9) meteorological sensor protection (temperature, humidity).

Figure 1–12 – RST line

### 1.2.4.3. Links between units

The MP101M requires power supplies and external links shown below:

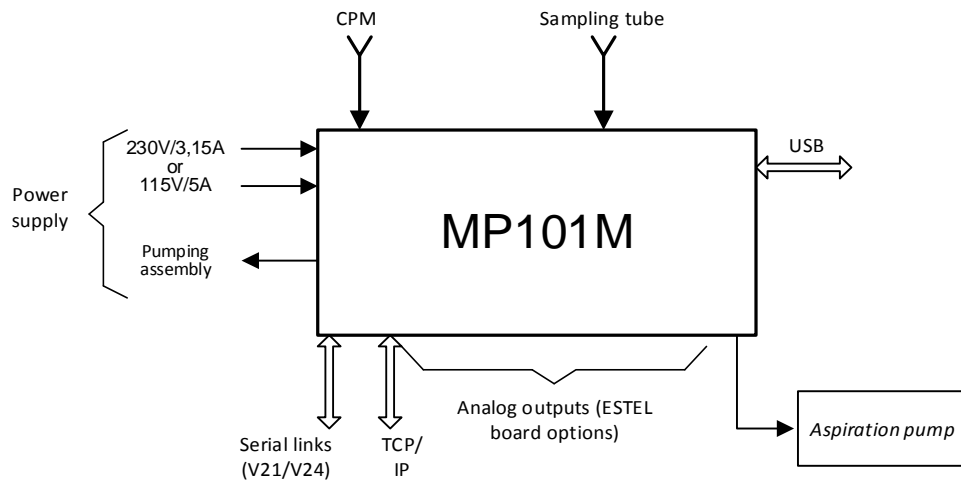


Figure 1–13 – Links between units

### 1.2.4.4. Dimension and weight (Figure 1–14)

The device is in the form of a standard 19-inch, 6-unit rack.

Length : 360.5 mm

Width : 483 mm

Height : 266 mm

Weight : 15.2 kg

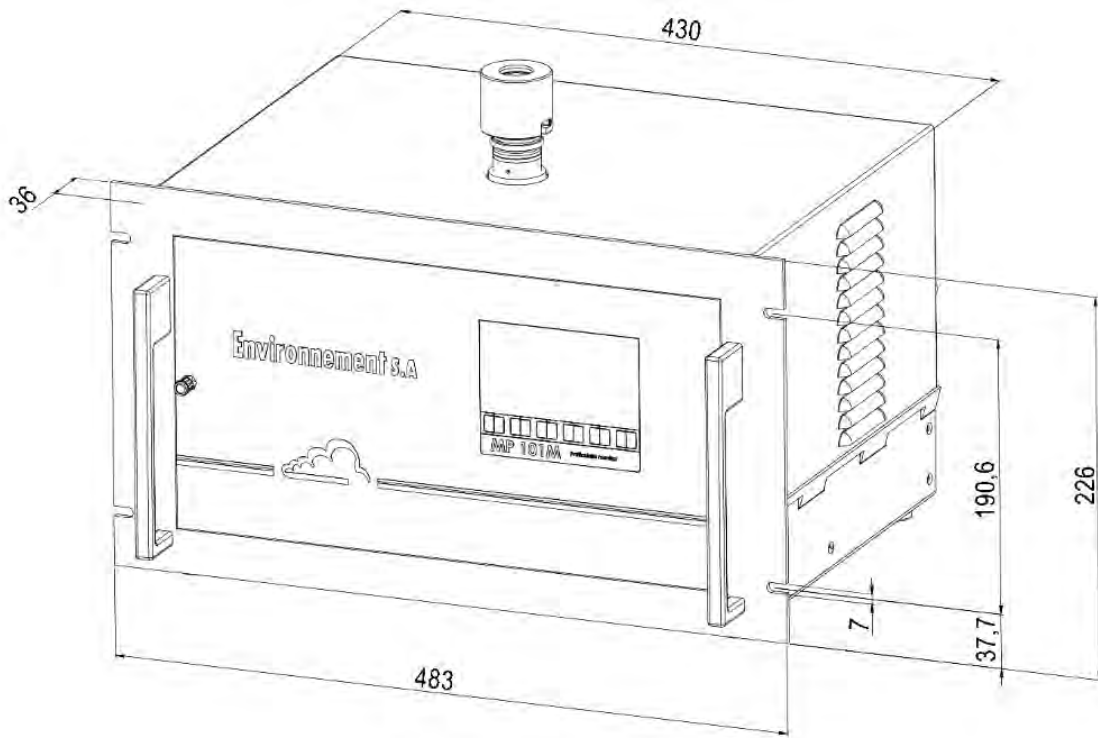
+ External pump : Picolino : 4,6 kg or KNF : 9,4 kg

### 1.2.4.5. Handling and storage

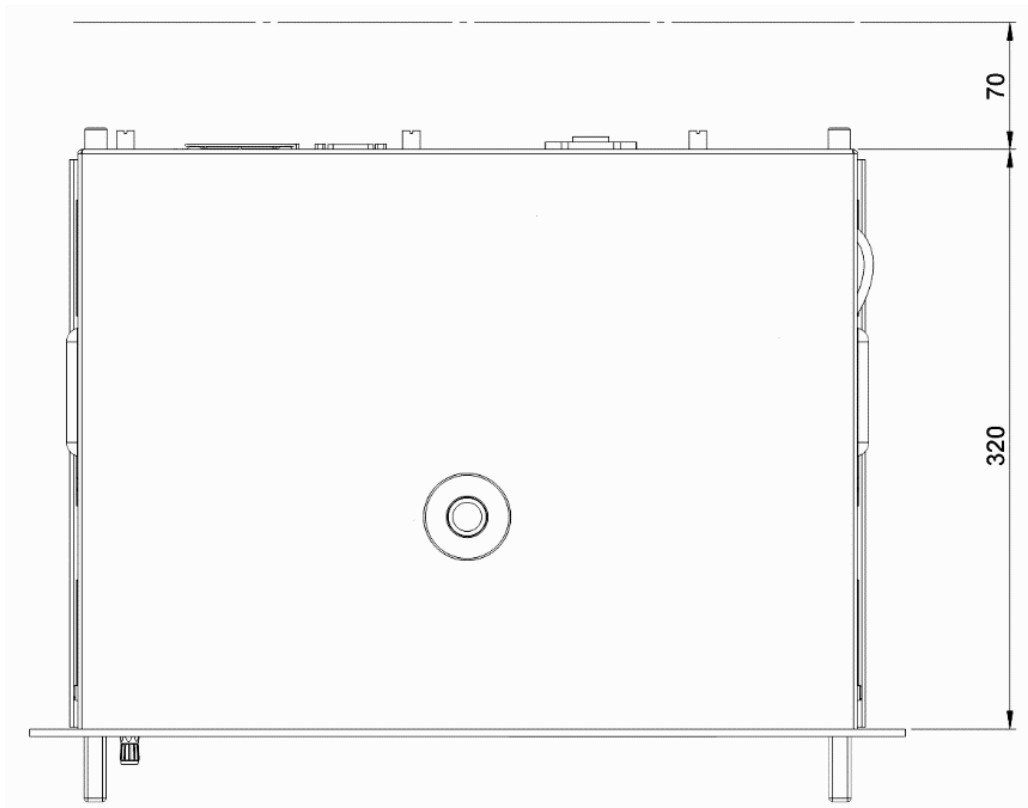
It is absolutely necessary to refer Safety Guidelines (CS1 to CS9) relative to equipment using radioactive sources.

The MP101M must be handled with care to avoid damage to the various connectors and fittings on the rear panel.

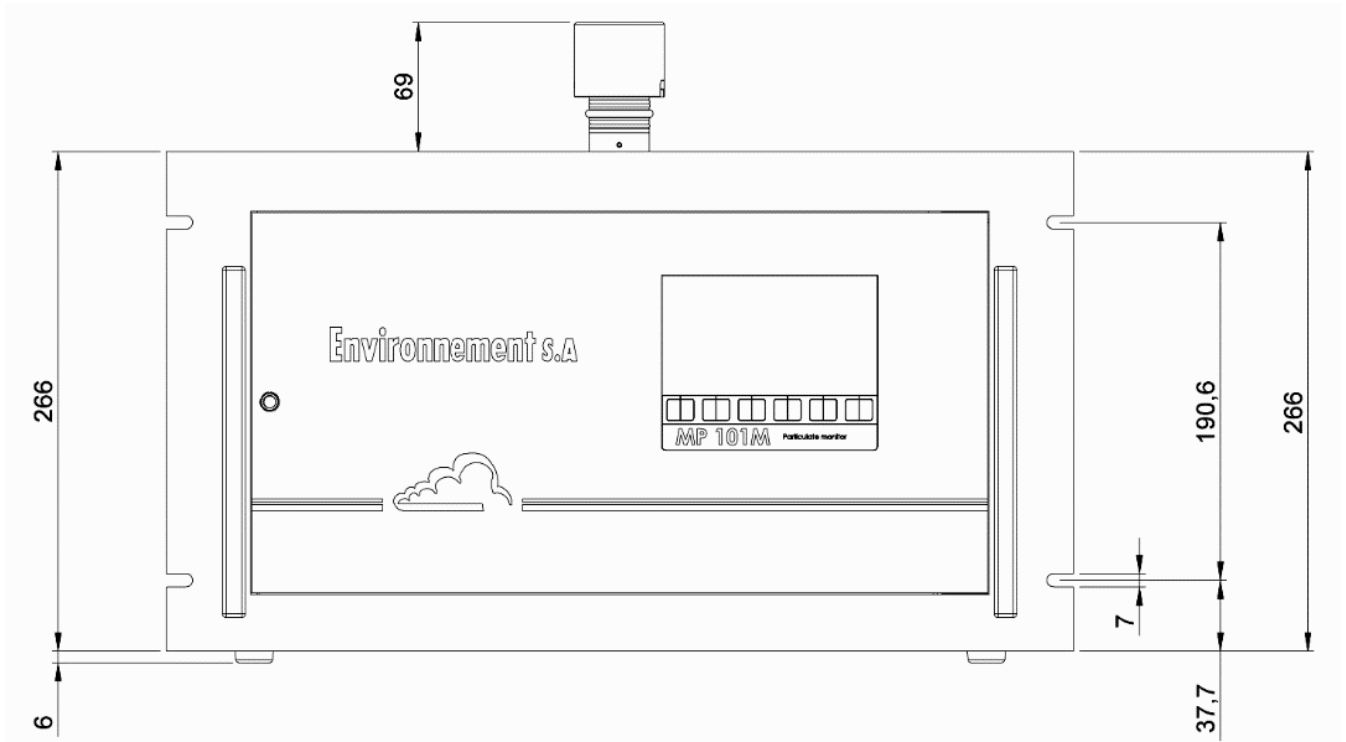
The unit is stored in a box provided for this purpose.



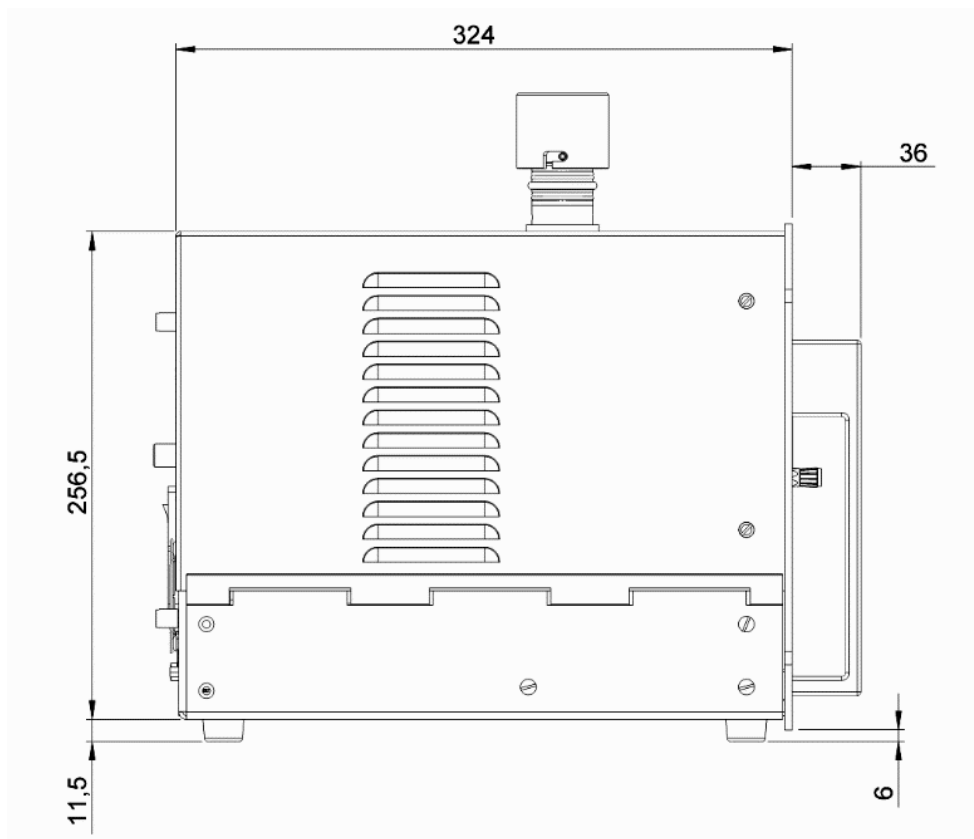
Dimensions – Overview



Dimensions – Above view



Dimensions – Front view



Dimensions – Side view

Figure 1-14 – Outline dimensions

## 1.2.5. CERTIFICATIONS

### 1.2.5.1. USEPA designation: PM10 (EQPM – 0404 – 151), PM2.5 (EQPM – 1013 – 211)

#### *Environnement S.A. Model MP101M PM10 Monitor*

##### **Automated Equivalent Method: EQPM-0404-151**

“Environnement S. A. Model MP101M PM<sub>10</sub> Beta Gauge Monitor,” configured with the louvered PM<sub>10</sub> inlet specified in 40 CFR 50 Appendix L or its flat-topped predecessor version and one of the three optional temperature-regulated sampling tubes (RST), and operated with the sample flow rate set to 1.00 m<sup>3</sup>/h and in accordance with the Ambient Air Continuous Particulate Monitor Model MP101M operation manual. With or without optional ESTEL analog inputs/outputs and touchscreen user interface, serial link: 1 RS-232/422; USB port; Ethernet port (TCP/IP). This designation applies to PM<sub>10</sub> measurements only.

**Federal Register: Vol. 69, page 18569, 4/8/2004**

**Latest modification: 9/2017**

#### *Environnement S.A. Model MP101M PM2.5 Monitor*

##### **Automated Equivalent Method: EQPM-1013-211**

“Environnement S.A. Model MP101M PM<sub>2.5</sub> Beta Attenuation Monitor” using a glass fiber filter tape roll, operated at a sample flow rate of 16.67 liters/min for 24-hour average measurements of PM<sub>2.5</sub>, configured with the standard EPA PM<sub>10</sub> inlet (meeting 40 CFR 50 Appendix L specifications) associated with a BGI Very Sharp Cut Cyclone (VSCC™) particle size separator and using a temperature regulated sampling tube with ambient meteorological sensor. With or without optional ESTEL analog inputs/outputs and touchscreen interface, serial link: 1 RS-232/422; USB port; Ethernet port (TCP/IP). Instrument must be operated in accordance with the Ambient Air Continuous Particulate Monitor Model MP101M operation manual. This designation applies to PM<sub>2.5</sub> measurements only.

**Federal Register: Vol. 78, page 67360, 11/12/2013**

**Latest modification: 9/2017**

### 1.2.5.2. European Designation

The automatic analyzer of particle, MP101M Color model, is being approved in Europe for regulatory measurement of PM<sub>10</sub> and PM<sub>2.5</sub>, according to the EN 16450 standard.

During the German TÜV Rheinland approval tests, the configuration of the analyzers was as follows:

ANALYZER CONFIGURATION DURING TÜV RHEINLAND TESTINGS	
Period time	1h
Cycle time	24h
RST configuration	« RH GM » mode Hygrometry threshold = 50%
RST length	2m
Sampling heads	PM <sub>10</sub> : US EPA type, supplied by ENVEA PM <sub>2,5</sub> : VSCC adapter
Integration	Inside air-conditioned local

## CHAPTER 2

### PRINCIPLE OF OPERATION

2.1.	BETA GAUGE PRINCIPLE	2-3
2.2.	DEPOSITED MASS CALCULATION	2-4
2.3.	FLOW RATE REGULATION PRINCIPLE	2-6
2.4.	MEASUREMENT MODE	2-8
2.5.	« ZERO TEST » MODE	2-11
2.6.	TEMPERATURE REGULATED SAMPLING TUBE (RST)	2-11
2.6.1.	PROTECTIONS AGAINST CONDENSATION	2-11
2.6.2.	PROTECTIONS AGAINST LOSSES BY VOLATILIZATION	2-12

Figure 2-1 – General principle diagram	2-2
Figure 2-2 – Beta radiation gauge	2-3
Figure 2-3 – Flow rate control diagram	2-6
Figure 2-4 – Measurement management	2-9
Figure 2-5 – RST line assembly	2-14



2. PRINCIPLE OF OPERATION

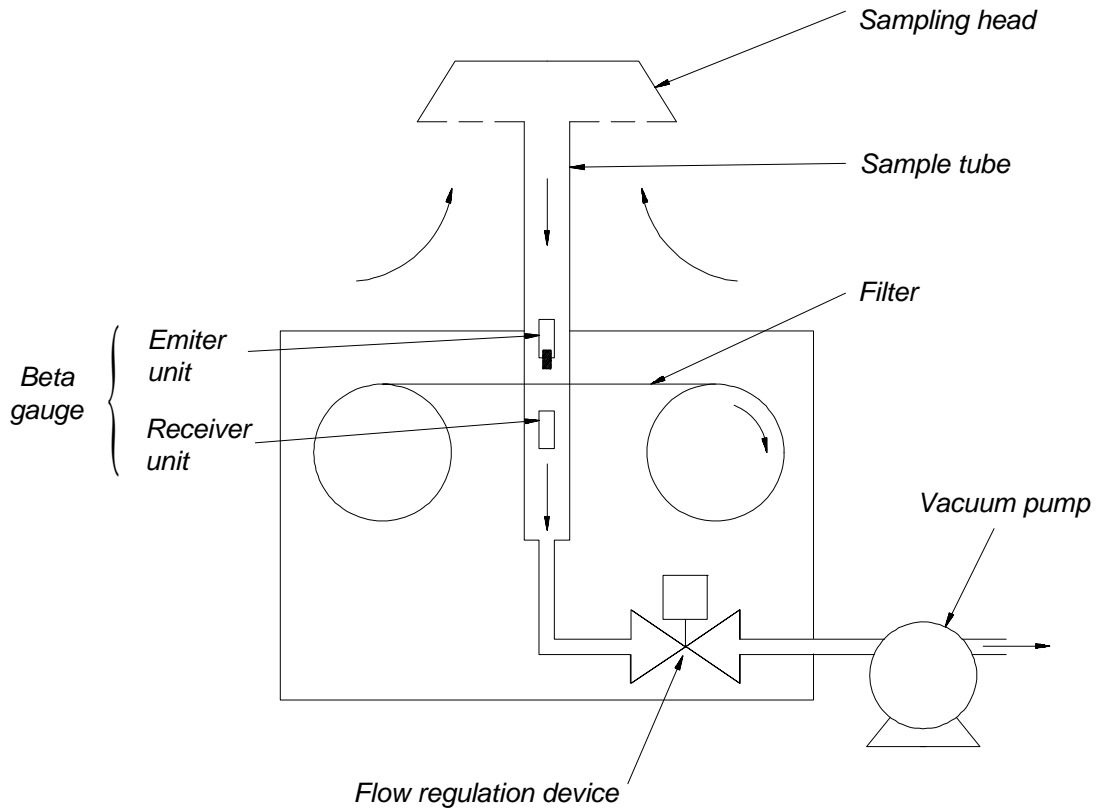


Figure 2-1 – General principle diagram

## 2.1. BETA GAUGE PRINCIPLE

A BETA gauge consists of a radioactive source of Carbon 14 ( $^{14}\text{C}$ ) radioelement, emitting Beta radiations and a radioactive ray detector, the Geiger-Müller (G.M.) tube. It is fixed at a given distance, downstream the filter ribbon which gathers the particles suspended in the air.

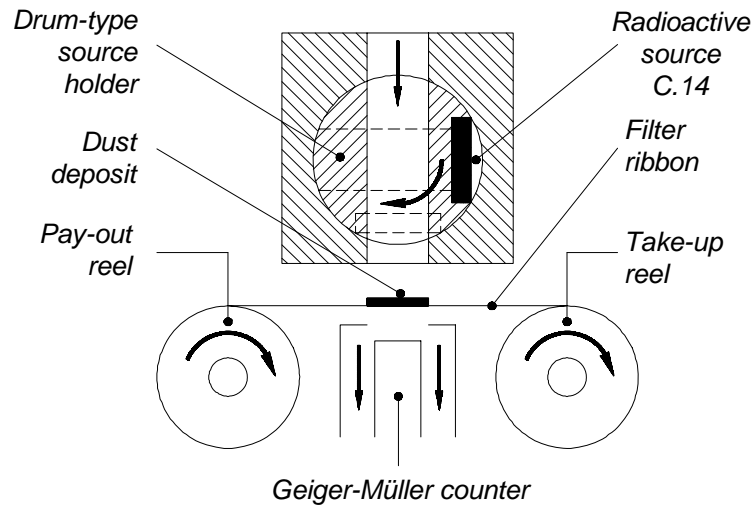


Figure 2-2 – Beta radiation gauge

When determining a mass deposit on the filter, the source faces the dust deposit and the counter (G.M.).

The beta rays are absorbed by the matter proportionally to its mass surface.

This matter consists of the glass fiber filter, the deposited particles and the air between the source and the G.M.

The mass measurement of the sampled particles in the ambient air consists in calculating the absorption difference between the blank filter and the loaded-particle filter.

This measurement technique advantage is to be independent from the physico-chemical nature of the sampled particles.

## 2.2. DEPOSITED MASS CALCULATION

The calculation of the deposited particle mass on the filter between two measurements takes into account the air volume variation comprised between the detector and the source.

This taking account is essential because, sometimes, this small air volume mass (few cm<sup>3</sup>) is not negligible compared with the collected particle mass. This mass also varies strongly with some parameters such as the measured temperature near the filter. This temperature may vary by more than 10 ° C in a few hours during some periods of the year.

The calculation of the collected particles mass on the filter is summarized below:

- Blank filter measurement :

The measurement follows an exponential distribution as:

$$N_1 = N_0 e^{-k(m_0 + m_1)}$$

With:

- k : mass absorption coefficient (depending on the source and filter properties)
- N<sub>0</sub> : GM detector measurement without absorbing element (counts/second)
- N<sub>1</sub> : GM detector measurement after beta radiation absorption by the blank filter and the air (counts/second)
- m<sub>0</sub> : blank filter mass (µg/cm<sup>2</sup>)
- m<sub>1</sub> : air mass at measurement time N<sub>1</sub> (µg/cm<sup>2</sup>)

**REMARK:** The corrected value N displayed on the analyzer is deduced from the not-corrected raw value N', depending on the detector dead time θ, by the formula:

$$N = \frac{N'}{1 - N' \theta}$$

The dead time corresponds to the duration while the detector remains « blind » following the first ionizing particle detection. It is equal to 50µs for the MP101M detector.

- Loaded-particle filter measurement :

$$N_2 = N_0 e^{-k(m_0 + \Delta m + m_2)}$$

With:

- N<sub>2</sub> : GM detector measurement after beta ray absorption by the filter, the collected particles and the air (counts/second)
- Δm : deposited particle mass (µg/cm<sup>2</sup>)
- m<sub>2</sub> : air mass at measurement time N<sub>2</sub> (µg/cm<sup>2</sup>)

- Deposited mass calculation  $\Delta m$  between the measurements N1 and N2:

$$\frac{N_1}{N_2} = e^{k(\Delta m + m_2 - m_1)}$$

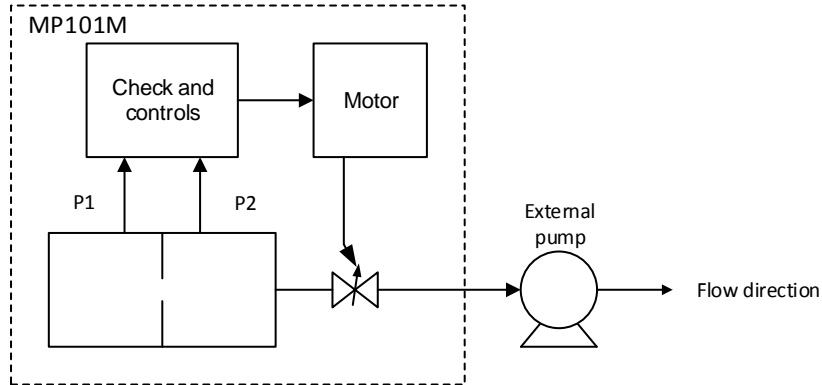
From which the final relation is obtained ( $\mu\text{g}/\text{cm}^2$ ):

$$\Delta m = \frac{1}{k} \text{Ln} \left( \frac{N_1}{N_2} \right) + m_1 - m_2$$

### 2.3. FLOW RATE REGULATION PRINCIPLE

Sampling is performed at constant volumetric flow rate, with compensation of the pressure loss due to the filter and the progressive dust deposit.

The flow rate is checked and maintained at the setting value of  $1,0 \text{ m}^3/\text{h}$ .



**Figure 2-3 – Flow rate control diagram**

P1 and P2 indicates the absolute static pressure measured on both sides of a diaphragm. These pressures are measured through two perpendicular tubes to the fluid flow direction and located very close to the diaphragm.

The diaphragm is manufactured and installed in order to obtain near a turbulent flow. On the other hand, the pipe and orifice diameters are such as, in most cases  $\frac{P_2}{P_1} > 0,9$ , allowing to consider the flow as incompressible and to minimize the pressure loss effects.

The internal temperature and pressure sensors, as well as sensors located on the sampling line, allow to measure the flow rate at the sampled air conditions.

Two configurations are possible:

- The analyzer is installed in an enclosure or a cabinet on its measurement site. It is connected to a RST line, and it samples outdoor air using a sampling head placed upstream the RST line.

In this case, the flow rate is calculated at the atmospheric conditions, in order to be regulated around the setting value (1 m<sup>3</sup>/h) at the sampling head level. This is essential to ensure the correct particle size separation through the sampling head. The efficiency of the particle size separation is optimal at the setting flow rate.

In these conditions, the flow rate is stated as follow:

$$\text{Flow rate} = K \times (T_0 + T_{\text{atmo}}) \times \sqrt{\frac{1}{T_0 + T_{\text{filter}}}} \times \frac{\sqrt{P_1 \times \Delta P}}{P_{\text{atmo}}}$$

Where:

- $\Delta P = P_1 - P_2$  is the difference between the two pressures measured upstream and downstream the diaphragm.
  - $T_0$  is the reference temperature stated in K ( $T_0 = 273.15$  K).
  - $T_{\text{filter}}$  is the temperature measured near the filter and the GM detector (named « GM Temperature » in the MP101M equipped with the « GM sensors » I2C board) stated in °C.
  - $T_{\text{atmo}}$  is the atmospheric pressure, stated in °C.
  - $P_{\text{atmo}}$  is the atmospheric pressure measured inside the MP101M, stated in mbar.
  - K is a constant.
- The analyzer is installed inside a building or a cabinet. It is not connected to a RST line, and samples indoor air.

In this case, the flow rate is calculated at the ambient room conditions where the MP101M is installed, in order to be regulated around its setting value (1 m<sup>3</sup>/h) at its sample inlet level.

In these conditions, the flow rate is stated as follow:

$$\text{Flow rate} = K \times \sqrt{(T_0 + T_{\text{filter}})} \times \frac{\sqrt{P_1 \times \Delta P}}{P_{\text{atmo}}}$$

Where:

- $\Delta P = P_1 - P_2$  is the difference between the two pressures measured upstream and downstream the diaphragm.
- $T_0$  is the reference temperature stated in K ( $T_0 = 273.15$  K).
- $T_{\text{filter}}$  is the temperature measured near the filter and the GM detector (named « GM Temperature » in the MP101M equipped with the « GM sensors » I2C board), stated in °C.
- $P_{\text{atmo}}$  is the atmospheric pressure measured inside the MP101M, stated in mbar.
- K is a constant.

## 2.4. MEASUREMENT MODE

Measurements are organized in cycles and periods. The period is the time interval between two intermediate weightings performed during a cycle. The cycle is the time interval between two filter advances, i.e. two weightings on blank filter.

Thus, measurement results will be of two types: periodic and/or cyclic.

### a) Cyclic

This measurement type allows better accuracy, the cycle duration is chosen for the dust mass deposited on the filter to be maximum (depending on the operating site). In general, the cycle duration is fixed at 24 hours to allow the daily measurement of PM10 and PM2.5.

During approval tests obtained by the MP101M for the PM10 and PM2.5 measurement, the cycle duration was fixed to 24 hours in order to be compared with the gravimetric reference method.

### b) Periodic

This measurement, less precise than the cyclical measurement, allows an intermediate dust mass measurement during the deposit, and consequently allows to track a quick pollution event.

Given that, when choosing an operation with cycles and periods, both measurement types will be expressed through the « Cyclic concentration » and « Periodic concentration » measurement channels.

A period is divided in two steps:

- 1) The particle sampling on the filter during a duration  $S$  (grey on the figure).
- 2) The measurement which lasts 200 seconds and takes place at the sampling end.

**REMARK:** In case of the first cycle period, two other steps take place before the first sampling step:

- Blank filter drying during 120 seconds.
- First measurement step on blank filter during 200 seconds (in general, this measurement is named « blank »).

The first periodic concentration  $C_1$  ( $\mu\text{g}/\text{m}^3$ ) is obtained at the end of the first period.

In the same way, the second periodic concentration  $C_2$  ( $\mu\text{g}/\text{m}^3$ ) is obtained at the end of the second period.

Two measurements are obtained at the end of the last period ( $N$  period):

- The Periodic concentration  $C_N$  ( $\mu\text{g}/\text{m}^3$ ): it only takes into account the sampled particle mass during the  $N$  period.
- The cyclic concentration  $C_{\text{cycle}}$  ( $\mu\text{g}/\text{m}^3$ ): it takes into account the mass of the whole sampled particles during the cycle (from period 1 to period  $N$ ).

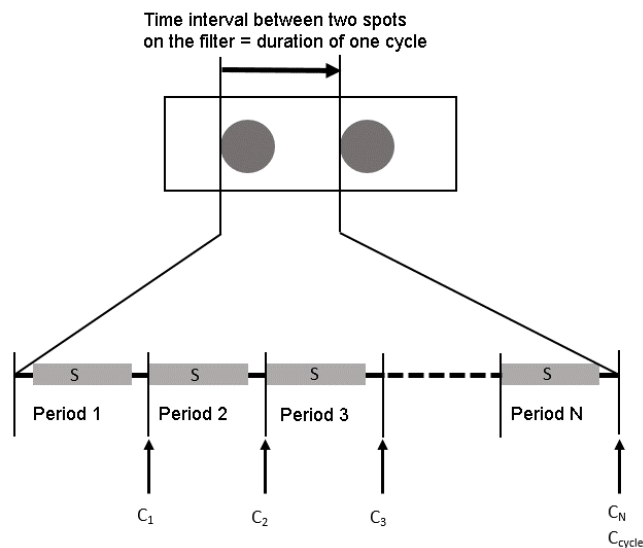


Figure 2–4 – Measurement management



### c) Filter clogging

During a measurement cycle, the filter can be advanced if the clogging function is activated. A clogging detection is done when the upstream pressure P1 is lower than a threshold value, indicating that the flow rate control is no longer possible.

Two cases are possible:

- If clogging occurs when it lasts less than 30 minutes before the end of the current period, the analyzer automatically stops the pump and waits. Afterwards, it performs its periodic measurement at the time originally scheduled, then it moves forward the paper to start up a new period on a blank filter portion (after a « blank »).
- If clogging occurs when it lasts more than 30 minutes before the end of the current period, the analyzer stops the pump and performs immediately an intermediate periodic measurement. Then, it moves forward the paper to terminate the period on a blank filter portion (after a « blank »).

In both cases, the analyzer does not consider this filter portion change as the beginning of a new cycle. Thus, the end of the current cycle is not shifted and occurs at a time originally scheduled before clogging.

When the clogging function is activated, the « Clogging » message is displayed on the Synoptic screen until the current cycle end.

**REMARK:** Clogging can be triggered in case of very high pollution peak (about mg/m<sup>3</sup>) or when an element obstructs the sampling circuit.

If the analyzer is installed on a very polluted site and the clogging function is activated frequently, it is recommended to reduce cycle duration. Indeed, an important particle deposit on the filter may create a high pressure loss and prevent the correct flow regulation.

### d) Floating average

It is a periodic concentration average. Its integration duration and its calculation steps are programmable.

Example of a floating average over 24 hours and calculated with a 1-hour time step: every hours, the system calculates hourly the average of the periodic concentrations delivered during the last 24 hours. In case of a period duration equal to 2 hours, the floating average is the result of the last 12-period average.

### e) Average concentration

The average concentration, calculated at the end of an n-period of the cycle, takes into account the whole particles sampled on the filter from the cycle beginning up to the end of this n-period. Consequently:

- After the first period of a cycle, the average concentration is equal to the periodic concentration C<sub>1</sub>.
- After the second period, the average concentration takes into account the mass of the whole sampled particles from the first period to the second period.

Therefore, it is different from the periodic concentration C<sub>2</sub> which only takes into account the particles sampled during the second period.

- At the cycle end, the average concentration is equal to the cyclic concentration C<sub>cycle</sub>.

## 2.5. « ZERO TEST » MODE

Measurement checks to zero must be performed regularly as part of standard analyzer operation. The test frequency is determined by the regulation in-force in the country of use.

This check requires to install an absolute filter (HEPA) on the analyzer sample inlet.

A screen dedicated to this test is available in the « *Zero test* » menu. It allows to configure the test duration and the value number to be taken into account (cycles or periods).

The zero test starts up and runs like a standard measurement cycle. All the data are stored in the measurement channels configured by the user.

At the test end, the analyzer finalizes automatically its measurement cycle, and it calculates the measurement average to determine a zero level. The zero level and its standard variation are compared to thresholds modifiable by the user. The test result is edited in a report available in the « *Zero test* » menu.

## 2.6. TEMPERATURE REGULATED SAMPLING TUBE (RST)

The RST (Regulated Sampling tube) line is composed of an internal stainless steel tube through which the particles sampled in the ambient air are transported. The stainless steel has the advantage to be electrically conductive. It is also inert and non-corrosive.

The internal tube diameter of the RST line was defined in order to obtain a laminar flow for a nominal flow rate of 1 m<sup>3</sup>/h. The particulate matter losses, resulting from scattering or shock effects, inertia or turbulence, are thus reduced.

This tube is integrated in a protective sheath of 60mm-external diameter which allows to fix the RST line on a shelter, an enclosure or a cabinet roof.

The RST line is available in different lengths (1m, 1.5m, 2m, 2.75m, or other on request).

### 2.6.1. Protections against condensation

Whatever the line length, a heating ribbon is coiled around the inner tube over a distance of 1m from the bottom (part connected to MP101M). It is thus possible to heat the inner tube to avoid air condensation at analyzer inlet.

Condensation may occur, for example, when a hot and humid air is cooled in an RST line ending up in an air-conditioned room at a setting temperature lower than the dew point.

#### DEW-POINT REMARKS:

- The dew point is a thermodynamic data characterizing gas moisture. The air dew-point is the temperature where the partial vapor pressure is equal to its saturation vapor pressure. Condensation occurs when humid air is gradually cooled up to the dew point.
- The dew point is calculated and checked in continuous in the MP101M. It allows to anticipate any condensation in the tube or on the filter and the GM detector. In case of condensation risk, the « Head condensation » or « GM condensation » alarms are automatically activated.

The droplet formation by condensation can destroy the GM detector, so it is essential to avoid this phenomenon.

Consequently, it is strongly recommended to keep the setting temperature of the air-conditioner upper than 26°C.

### 2.6.2. Protections against losses by volatilization

The RST-line heating set-point is checked in continuous and set as low as possible in order to limit the particulate matter losses by volatilization.

Many control modes are possible:

– «  $T^{\circ}_{\text{head}} = f(T^{\circ}_{\text{atmo}})$  »

This mode allows to control the heating set-point according to the relative humidity rate and the atmospheric temperature. This temperature is measured with a «  $T^{\circ}_{\text{head}}$  » sensor inserted on the internal conduit of the RST line and placed at about 1m of the analyzer sample inlet.

In this mode:

- Heating is triggered if the outdoor relative humidity, measured by the weather sensor of the RST line, exceeds the programmed threshold H.
- Heating is controlled so that the «  $T_{\text{head}}$  » temperature reaches the setting ( $T_{\text{atmo}} + T$ ) where T corresponds to the programmed temperature shift.

The recommended configuration for this measurement mode is the following:

- PM10 measurement: Humidity threshold H = 60%  
Temperature shift T = 5°C
- PM2.5 measurement: Humidity threshold H = 75%  
Temperature shift T = 5°C

– «  $T^{\circ}_{\text{GM}} > f(P_{\text{dew}})$  »

This mode allows to trigger the heating set-point according to the sampled air dew-point, and the measured air temperature close to the GM detector.

In this mode, the heating is triggered if the temperature near the GM detector is lower or equal to the value ( $P_{\text{dew}} + T$ ) where T corresponds to the programmed temperature shift.

The recommended configuration for this measurement mode is the following:

- (Humidity threshold non-active)
- Temperature shift T = 5°C

– « HR<sub>GM</sub> »

This mode allows to control the heating set-point according to the relative humidity rate measured near the GM detector.

In this mode, the heating is triggered if the relative humidity rate near the GM detector is upper than the programmed humidity threshold H.

This mode keeps the filter and the collected particles by the MP101M to a relative humidity level close to the storage and weighing filter conditions of the reference gravimetric method.

**This mode is recommended. It is configured by default in the analyzers after manufacturing.**

The recommended configuration for this measurement mode is the following:

- Humidity threshold H = 50%
- (Non-active temperature shift T)

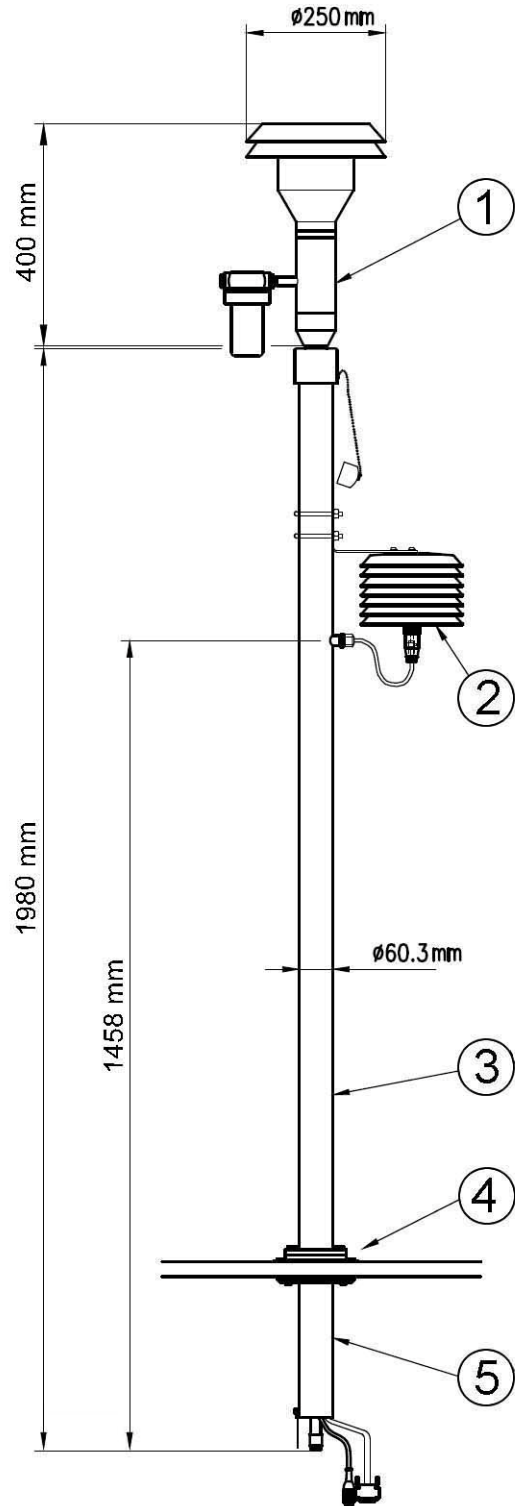
– The « Always » mode allows to heat the line in continuous without regulation.

The user must avoid using this mode to limit the particulate matter losses because the channel temperature can increase up to 70 ° C.

This mode can be used punctually to dry a line exposed to rain or high humidity rate (while the analyzer was switched off).

– The « OFF » mode is used to disable the RST option. Heating is never activated.

**WARNING:** The meteo sensors of the RST line are not taken into account in the « OFF » mode. Consequently, the flow rate is controlled in comparison with the temperature measured near the filter, and not in comparison with the atmospheric conditions.



(1) PM10 dust sampling head, (2) humidity and temperature sensor, (3) RST 200 sampling line, (4) roof mounting assembly, (5) heated tube.

Figure 2-5 – RST line assembly

## CHAPTER 3

### OPERATION

3.1.	INITIAL SART-UP	3-3
3.1.1.	PRELIMINARY OPERATIONS	3-3
3.1.2.	STARTING UP THE UNIT	3-4
3.2.	PROGRAMMING THE MP101M	3-8
3.2.1.	SCREEN AND KEYBOARD DESCRIPTION AND USE INSTRUCTIONS	3-8
3.2.1.1.	Control screens	3-8
3.2.1.2.	Keyboard input	3-9
3.2.2.	PROGRAMMING OPERATING PARAMETERS	3-11
3.2.2.1.	Fields requiring character input	3-11
3.2.2.2.	Fields requiring parameter selection in a list	3-11
3.2.2.3.	OFF/ON status buttons	3-11
3.3.	BROWSING ERGONOMY	3-12
3.4.	DESCRIPTION OF ANALYZER FUNCTIONS AND SCREENS	3-17
3.4.1.	STANDARD FUNCTIONS	3-17
3.4.1.1.	Analyzer controls	3-17
3.4.1.2.	Measurement display	3-18
3.4.1.3.	Real time graph display	3-21
3.4.1.4.	Analyzer synoptic diagram	3-24
3.4.1.5.	Information panel	3-28
3.4.1.6.	Contextual help operation	3-29
3.4.2.	ADVANCED FUNCTIONS	3-30
3.4.2.1.	Password management	3-30
3.4.2.2.	General configuration (Address, Protocol, Measurement channels...)	3-31
3.4.2.3.	Automatic function configuration	3-34
3.4.2.4.	Language selection	3-35
3.4.2.5.	Find and display recorded averages	3-36
3.4.2.6.	Delete all recorded averages	3-37
3.4.2.7.	List of connected clients	3-37
3.4.2.8.	Diagnostic functions (alarm, input / output, mux...)	3-38
3.4.2.9.	Setting the analyzer in stand-by mode	3-40
3.4.2.10.	Setting the analyzer in maintenance mode	3-40

---

3.4.2.11. Advanced analyzer configuration	3-41
3.4.2.12. Hardware function tests	3-46
3.4.2.13. Gauge calibration	3-62
3.4.2.14. Flow calibration	3-65
3.4.2.15. USB function activation	3-68
3.4.2.16. Optional interface configuration	3-70

Figure 3-1 – Fluid and electrical connections	3-3
---	-----

### 3. OPERATION

#### 3.1. INITIAL SART-UP

The analyzer is checked and calibrated in the factory before delivery. However, some parameters must be checked on-site when starting-up the analyzer to ensure correct operation.

##### 3.1.1. PRELIMINARY OPERATIONS

Refer to Figure 3-1.

First start-up consists in carrying out the following preliminary operations:

- Visually examine the analyzer inside to ensure that no element was damaged during transport.
- Connect the pump power supply cable to (5) and the pump aspiration pipe to (8) on the MP101M rear panel.
- If the start-up is carried out in a measurement station, set-up the sampling line following the recommendations given in chapter 1 of the manual. Connect the two sampling line cables to the connectors (3) and (6) on the MP101M rear panel.
- Check that the analyzer switch is "OFF". Then, use the power cable supplied with the analyzer to connect the mains power supply block (1) with a 230 V / 50 Hz + earth or 115 V / 60 Hz + earth socket, following the supply voltage specified in the order.
- Use a TCP / IP cable and connect it to (7) to allow MP101M network communication.
- Use a serial cable and connect it to (4) to allow MP101M serial communication (RS232 or RS422).
- Use a terminal block for ESTEL board and connect it to (10) to use analog inputs and outputs of MP101M.



(1) general fuse F1 and mains power supply block, (2) fan, (3) TUCHEL connector for tube heating, (4) RS232/RS422 socket, (5) external pump supply, (6) external temperature and humidity sensors, (7) TCP/IP socket, (8) pump outlet, (9) holding cover screws, (10) ESTEL board options, (11) connection socket to CPM option, (12) holding screws of the rear panel drawer.

**Figure 3-1 – Fluid and electrical connections**



### 3.1.2. STARTING UP THE UNIT

Carry-out, in the following order, the steps described below:

#### 1 – Press down the ON / OFF button located on the rear panel of the analyzer.

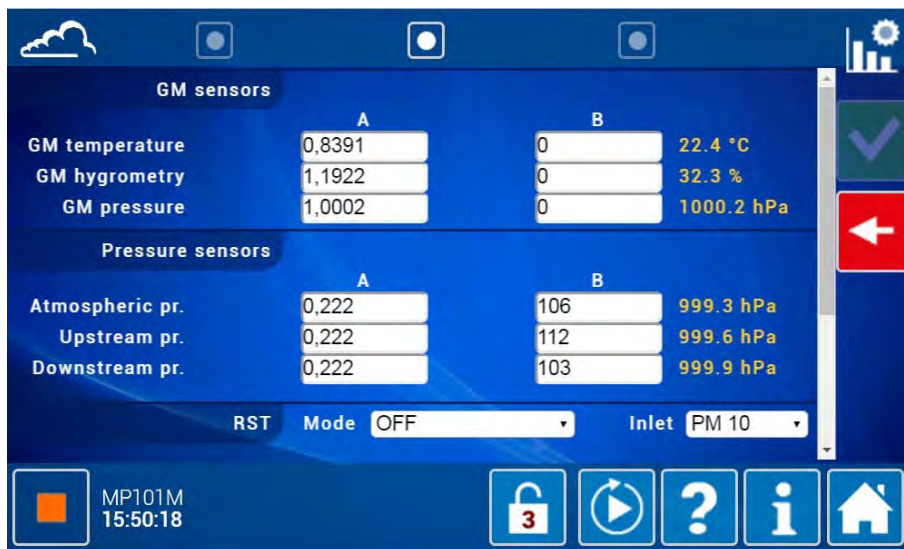
The welcome screen is displayed and the analyzer warms-up. During warming-up, the analyzer self-checks correct operation of its various parameters.

If all the operating parameters (pressure, temperature, voltage ...) are within the operational limits, the analyzer leaves the WARMING-UP mode automatically after a few seconds.

#### 2 – Check the pressure sensor calibration in the « Advanced analyzer configuration » screen, page 2.

Using a reference barometer, check the upstream, downstream and atmospheric pressure values when the pump is switched-off. They must equal the atmospheric pressure read on the barometer, with a +/- 1 mbar tolerance.

If it is not the case, it is necessary to modify the B linearization coefficient of the three sensors.



#### 3 – RST function configuration in the « Advanced analyzer configuration » screen, page 2.

- Control mode selection

RST section / MODE field: choose a control mode of the sampling line heating. See Chapter 2 for details about the operation principle of each mode.

HEATING REGULATION section: define the «T offset » and « Hygro. threshold » parameter values.

- Calibration parameter checking of T°C sensors:

RST section: check that the calibration parameters of the two temperature sensors (« Atmospheric T.» and « Head T. ») are the following:

**A = 0.1 and B = 0.**

- Calibration parameter checking of RH% sensors

RST section: in the « (S & Z) » line, input the two **S** and **Z** calibration coefficient values of the « Relative hydr. » sensor.

These coefficients are given on the calibration report provided with the meteorological sensor of the RST line (four decimal places are enough):

- S corresponds to « Slope » on the calibration report.
- Z corresponds to « Zero Offset » on the calibration report.

The screenshot shows the MP101M control interface. On the left, the 'Relative hydr.' section has two columns, A and B. Under the '(S & Z)' label, the values 32,1181 and 0,8129 are entered in red boxes. To the right, a calibration report for model HIH-4021-003 is shown. It lists various parameters and calculated values. Two values are highlighted with red boxes: 'Zero Offset: 0.812899 V' and 'Slope: 32.118094 mV/%RH'. Red arrows point from these report values to the corresponding input fields in the interface.

**NOTE :** Concerning the meteorological sensors delivered before 2016 with the CAPTHUMI-MON document (« Humidity sensor information sheet »): the S and Z values are indicated on the two last lines of the table. It is also possible to fill-in the A and B values of as shown in this document.

#### 4 – Carry out an instantaneous flow checking in the « *Flow calibration* » screen

A reference flowmeter is needed to carry out this checking. Two configurations are possible:

- Location : *inside*

The RST line is not connected and the RST option is not activated (« OFF » mode). The flowmeter has to be directly connected to the MP101M sample inlet.

- Location : *outside*

The RST line is connected and the RST option is activated (whatever the mode, « OFF » excepted). The flowmeter has to be connected to the RST line, instead of the sampling head.

**In both cases, the difference between the setting and the flow read on the flow meter must be lower than 5% in absolute value (instantaneous flow).**

**NOTE :** If the test fails, a new flow calibration must be carried out.

**5 – Carry out a mass test in the Mass test page of the « *Hardware function tests* » screen**

This test allows checking the analyzer calibration done in factory. The test lasts 1 hour for a programmed test number of 10.

If the automatic span option is not installed and activated, the user will have to insert the Reference gauge manually after about 30 minutes.

The test passes **if the difference between the measurement and the span mass is < 25µg/cm<sup>2</sup> in absolute value.**

**NOTE :** If the test fails, a new Beta Gauge calibration is required.

**6 – Configure the Measurement mode in the « *Advanced analyzer configuration* » screen**

The recommended configuration is the following:

- Cycle duration = 24h
- Period duration = 1h or 2h
- Count = 260s

Choose also the desired Start type (Immediate, Delayed, External synch., and Hourly re-sync.).

**7.a – Configure the measurement channels in the « *General configuration* » screen**

Refer to Tableau 3–1 listing all the available measurement channels, the recommended-for-diagnostic measurement channels are indicated with grey background: the user must configure these 10 greyed measurement channels.

The « Rel. Hygr. » and « Atmo. T° » measurement channels are essential to carry-out the next step.

**7.b – Configure the stored data in the « *General configuration* » screen**

Select an archive period = **1 min.** (the user could modify this value later, at step 10).

Cancel the stored data with the button  (this operation is irreversible).

**8 – Start measurement with the button .**

**NOTE :** During the first operation hours, it is necessary to install reference sensors for atmospheric temperature and relative humidity, on the measure site, or not too far (meteorological station sensors, sensors of other analyzers...).

It is necessary to collect these sensor data to compare them to MP101M data.

**9 – Calibration checking of the three RST line sensors (temperature and humidity)**

- After few operation hours, collect the stored data of the two « Rel. hygr. », « Atmo. T. » measurement channels.
- Check that the atmospheric temperature variation range is about 10 ° C over this period, and that the relative humidity variation exceeds 10%.
- Compare the RST line sensor data with the reference sensor data. The difference between these data must meet the following tolerances for all the period:
  - +/-2°C for atmospheric temperature
  - +/-5% for relative humidity

If these criteria are not verified, it is recommended to calibrate the RST line sensors with the reference sensors.

The recommended calibration procedure for the atmospheric temperature sensor and the relative humidity sensor is the following:

- Draw the point curve  $y=f(x)$  where  $y$ = reference sensor and  $x$ = RST sensor, for all the considered operation period,
- Then draw the regression line,
- And deduce the RST sensor linearization coefficients A (= regression line slope) and B (= regression line offset) from its equation.

Apply the coefficients A and B found for the « Atmospheric T. » sensor to the « Head T. » sensor.

**10 – The analyzer is ready for measurement**

At this step, it is possible to modify the data memorization period or any other configuration parameter.

If the measurement was stopped, it can be restarted.

## 3.2. PROGRAMMING THE MP101M

### 3.2.1. SCREEN AND KEYBOARD DESCRIPTION AND USE INSTRUCTIONS



The touch screen mounted on the front panel is also used to visualize the control screens and the virtual input screen allowing input and modification of the analyzer parameters. The control buttons are activated by touching.

When the analyzer is connected to a remote computer, parameters are modified with the computer keyboard, and control buttons are activated by clicking on with the mouse.

#### 3.2.1.1. Control screens



**The control screen areas are defined as follows:**

(1)	: Browsing bar of several-page screens. The user accesses the desired page by activating its corresponding button from  to  .
(2)	: Measurement or configuration area. This area displays the measurement parameters (concentration, value, units...) or the configurable parameters associated with the selected menu.
(3)	: Manual controls, information and browsing bar. This bar allows manual measurement start or stop, information panel and status display, and advanced or standard functions access.

Manual controls, information and browsing bar (3) is available in all screens. Details are given in section 3.3 related to ergonomics browsing.





### 3.2.1.2. Keyboard input

From the analyzer touch screen, a virtual touch-sensitive keyboard is displayed instantly in the bottom half screen part (2) when the user touches a field to be filled in or modified.

Two keyboard types are available: numeric keyboard if numeric entry is required or QWERTY keyboard if alphanumeric entry is required.

Examples below show the keyboard display in the « *General configuration* » screen.

When the user touches any keyboard key, the button (1)  becomes . It is used to validate entries and close the virtual keyboard. Button (3) is used to close keyboard without validation.

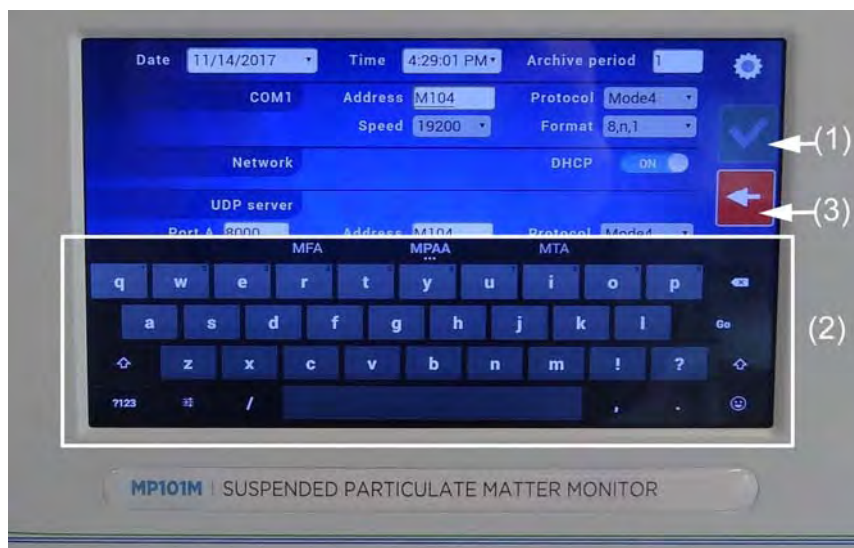
**NOTE :** Field inputs are indexed.

These keyboard keys work like Android system keys found on tablets and smart-phones.

Numeric keyboard is shown below (2):

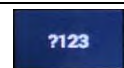


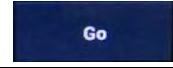
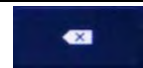


Alphanumeric keyboard is shown below (2):



(1) Entry validation button, (2) numeric keyboard with touchscreens, (3) button to close keyboard without validation.

**Button definitions specific to the virtual keyboard**


	: Switches from alphanumeric to numeric keyboard.
	: Switches from numeric to alphanumeric keyboard.
	: Switches from numeric to symbol keyboard.
	: Enters inputs.
	: Clears inputs.

From a remote computer, the user uses the computer keyboard with mouse.

### 3.2.2. PROGRAMMING OPERATING PARAMETERS


Two possible fields are available to input or modify parameters.

#### 3.2.2.1. Fields requiring character input

In front of the analyzer touchscreen, touch the input field to be modified. The virtual input screen is displayed with the QWERTY keyboard if alphanumeric entry is required, or the numeric keyboard if numeric entry is required. If letters and numbers are required in the same field, touch the **ABC** key to switch from numeric to alphanumeric keyboard, and the **?123** key to switch from alphanumeric to numeric keyboard. Input with the virtual touch keys, enter by touching the **Go** button, and validate with . The virtual keyboard closes and the modified field is displayed properly filled in.

When modification is done from a remote computer, the computer keyboard and mouse is used.

#### 3.2.2.2. Fields requiring parameter selection in a list


Touch the field to be modified. The list of parameters or values to be selected is displayed with the current parameter or value in blue background. Touch the desired parameter or value to select it. The new parameter or value is displayed in blue background. Validate with . The list closes, and this new parameter or value replaces the previous.



#### 3.2.2.3. OFF/ON status buttons

To switch OFF to ON, touch (or click on) the OFF button. The ON field becomes white in blue background. And vice versa.

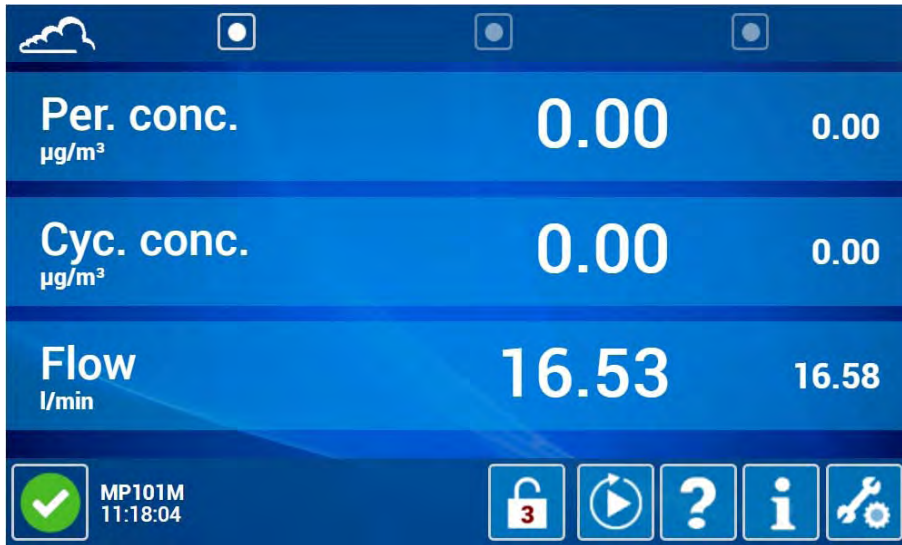


**NOTE :** After any modification performed in the same screen, the user must ALWAYS validate with  to take into account modification.



### 3.3. BROWSING ERGONOMY

The MP101M home page is the following:




The home page displays up to three measurement channels.

From the touch screen mounted on analyzer front panel, the home page gives access to the standard functions without using a password.



From a remote computer, the following page is displayed first:



The user enters the password in field (1) and validates with  to open the home page.

The home page is composed of two browsing bars:

- Top screen browsing bar

By activating  to , the user drags the display sideways to view the other pages: measurement channels, real time graph and analyzer synoptic diagram. This browsing bar is specific to the home page.










































- Bottom screen browsing bar


As indicated in 3.2.1.1 section, this bar allows manual launching cycles, information panel and status icons display, and advanced or standard functions access. This browsing bar is available in all screens.



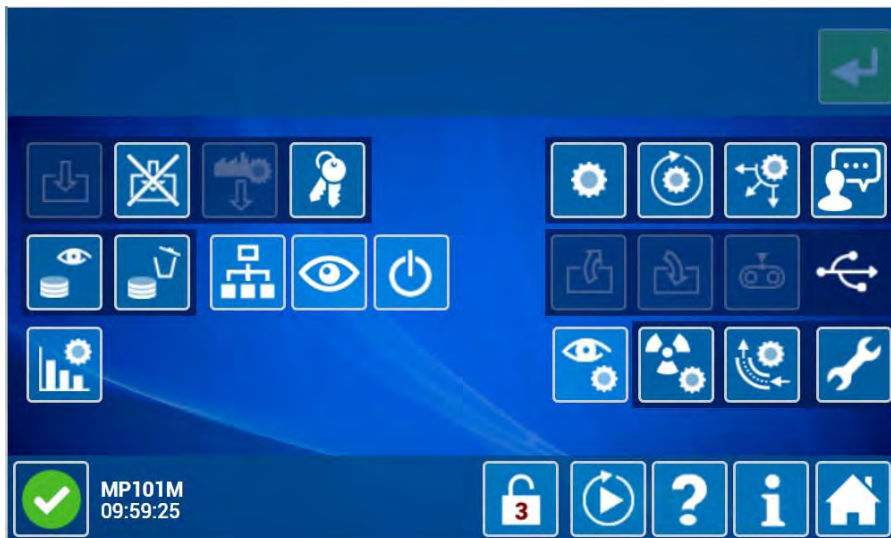
**Button, control and icon functions of this browsing bar are as follows:**




	<p>Status icon location. The various status icons are as follows:</p> <table border="1"> <tr> <td data-bbox="523 902 582 969"></td> <td data-bbox="582 902 1519 969">: Icon indicates that the analyzer operates normally.</td> </tr> <tr> <td data-bbox="523 969 582 1037"></td> <td data-bbox="582 969 1519 1037">: Icon indicates that the analyzer is warming-up.</td> </tr> <tr> <td data-bbox="523 1037 582 1104"></td> <td data-bbox="582 1037 1519 1104">: Icon indicates that the analyzer is in control mode.</td> </tr> <tr> <td data-bbox="523 1104 582 1171"></td> <td data-bbox="582 1104 1519 1171">: Icon indicates that the analyzer is in alarm mode.</td> </tr> <tr> <td data-bbox="523 1171 582 1238"></td> <td data-bbox="582 1171 1519 1238">: Icon indicates that the analyzer is disconnected from network.</td> </tr> <tr> <td data-bbox="523 1238 582 1305"></td> <td data-bbox="582 1238 1519 1305">: icon indicates that the analyzer is in maintenance mode.</td> </tr> <tr> <td data-bbox="523 1305 582 1373"></td> <td data-bbox="582 1305 1519 1373">: Status icon indicating that the analyzer is in stand-by mode.</td> </tr> <tr> <td data-bbox="523 1373 582 1440"></td> <td data-bbox="582 1373 1519 1440">: Status icon indicating that the analyzer is performing a zero test.</td> </tr> <tr> <td data-bbox="523 1440 582 1507"></td> <td data-bbox="582 1440 1519 1507">: Status icon indicating that the analyzer is stopped (i.e. not measuring).</td> </tr> </table>		: Icon indicates that the analyzer operates normally.		: Icon indicates that the analyzer is warming-up.		: Icon indicates that the analyzer is in control mode.		: Icon indicates that the analyzer is in alarm mode.		: Icon indicates that the analyzer is disconnected from network.		: icon indicates that the analyzer is in maintenance mode.		: Status icon indicating that the analyzer is in stand-by mode.		: Status icon indicating that the analyzer is performing a zero test.		: Status icon indicating that the analyzer is stopped (i.e. not measuring).
	: Icon indicates that the analyzer operates normally.																		
	: Icon indicates that the analyzer is warming-up.																		
	: Icon indicates that the analyzer is in control mode.																		
	: Icon indicates that the analyzer is in alarm mode.																		
	: Icon indicates that the analyzer is disconnected from network.																		
	: icon indicates that the analyzer is in maintenance mode.																		
	: Status icon indicating that the analyzer is in stand-by mode.																		
	: Status icon indicating that the analyzer is performing a zero test.																		
	: Status icon indicating that the analyzer is stopped (i.e. not measuring).																		
	<p>: Icon views warm-up progress.</p>																		
	<p>: Button stops the warm-up cycle in progress.</p>																		
	<p>: Button indicates analyzer password level and displays the window to change this password (shown below).</p> 																		



	: Button displays cycle start controls:  starts the cycle,  stops the current cycle.
	: Button displays contextual help.
	: Button displays analyzer information panel.
	: Button accesses the advanced analyzer functions.
	: Button accesses the home page.

The user displays the advanced function access screen by touching / clicking on the  button. The user-accessible function buttons are white-framed in blue background. They depend on the password level assigned to the user. Each button allows access to the associated screen.

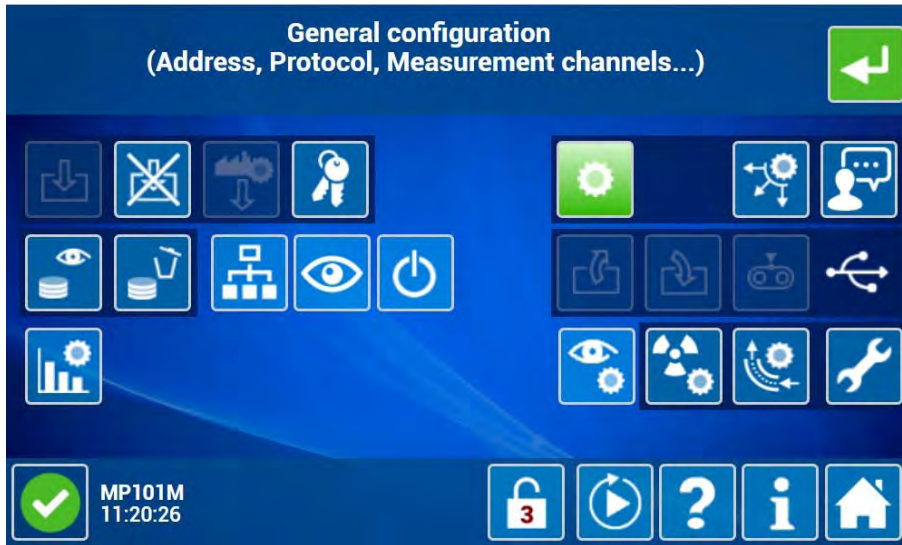
The advanced function access screen is the following:



When a button is activated, it changes color from blue  (e.g.) to green  (e.g.), while its function is displayed at screen top and  is activated to .




By touching / clicking on  or touching / clicking on again  (e.g.), the user accesses the corresponding screen.



Refer to the example given below « *General configuration (Address, Protocol, Measurement channels...)* »:
























**NOTE :** Access to the advanced functions depends on the hierarchical level of the user's password. There are three hierarchical levels: User, Advanced, and Expert.


The factory passwords available in the analyzer on delivery are the followings, symbolized by the icons:

Password level	Login	Icon
User	12345	
Advanced	78300	
Expert	00007	

On the initial start-up, it is strongly advised to change the factory passwords: activate  in the advanced function screen to display the password management window, input the new passwords in the corresponding fields, and activate  to validate the input and close the password management window.

**Button functions are as follows:**

	: Undoes the last upgrade
	: Restores factory settings. It is recommended to backup before executing this operation.
	: Passwords management.
	: General configuration. (Address, Protocol, Measurement channels...)
	: Automatic cycle configuration.
	: Optional interface configuration
	: Language selection.
	: Finds and displays the recorded averages.
	: Deletes all recorded averages. (Warning! this operation can't be cancelled)
	: List of connected clients.
	: Diagnostic functions (alarm, input / output, mux...)
	: Set the analyzer in standby mode
	: Advanced analyzer configuration.
	: Configuration and software backup on USB key.
	Restore software and configuration from USB key ( System will restart on operation completion )
	: Records instantaneous measurement on USB key.
	: Gives USB key characteristics (free and total memory) when connected to the analyzer.
	: Hardware functions tests
	: Gauge calibration
	: Flow calibration
	: Set the analyzer in maintenance mode

By touching / clicking on , the user returns to the home page.



### 3.4. DESCRIPTION OF ANALYZER FUNCTIONS AND SCREENS

#### 3.4.1. STANDARD FUNCTIONS

##### 3.4.1.1. Analyzer controls

Reminder: Touch / click on  to display  or .

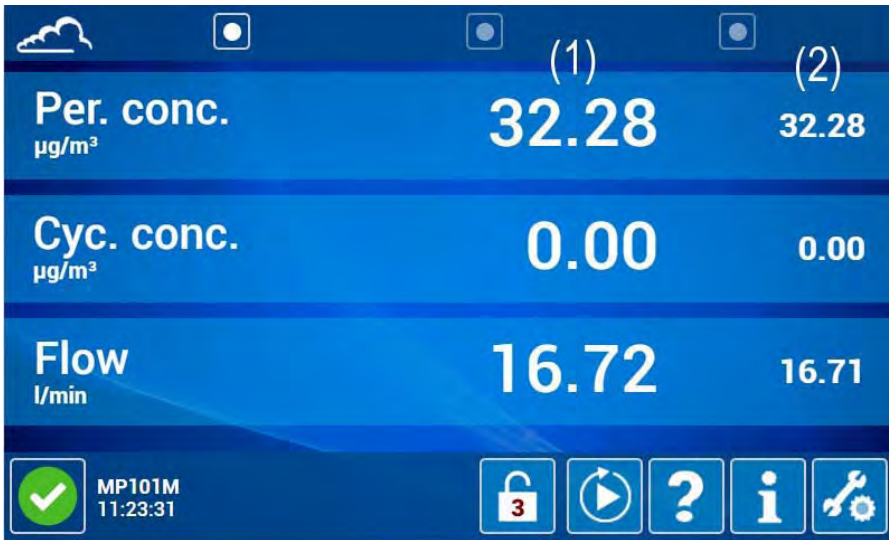
The analyzer controls are the followings:

Controls	Function description
	This button launches the measurement cycle.
	This button stops the measurement cycle.

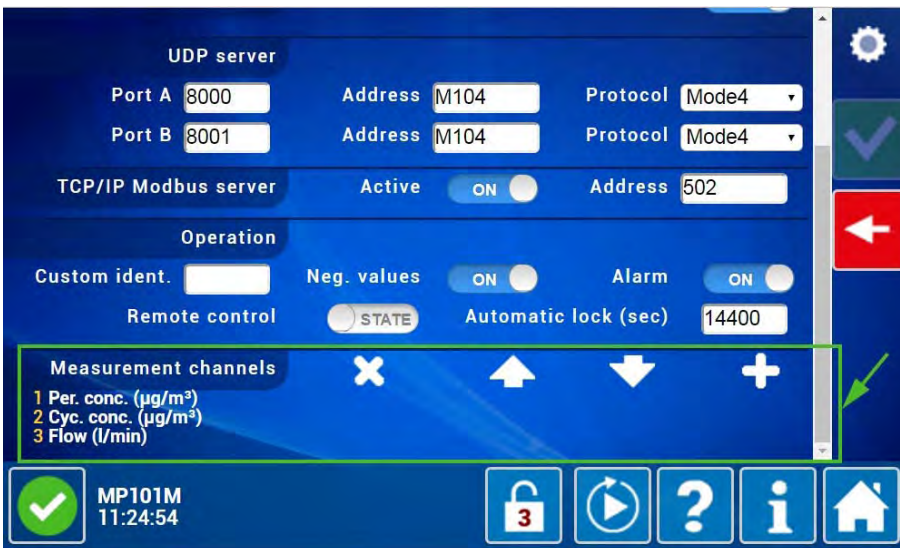


3.4.1.2. Measurement display





By default, the home page displays the measurement channels of the periodic concentration, the cyclic concentration and the flow. Column (1) gives the instantaneous measurement values and column (2), the average measurement values.




To display additional measurement channels, it is necessary to first select them in the Measurement channel section of the « General configuration » screen, as shown below (refer to green frame with arrow):




**Button definitions specific to this section:**

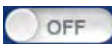


	: Deletes the selected measurement channel.
	: Moves upwards the selected measurement channel.
	: Moves downwards the selected measurement channel.
	: Opens the selection window to add measurement channels.


To select additional channels, touch/click on  to open the measurement channel selection window.

There are five measurement channel groups: Compounds, Voltage, Sensor, Calculation, and Analog inputs. By default, the compound group field is set to ON : the first three measuring channels, Per. Conc., Cyc. Conc., Flow, are selected and displayed in the measurement channel section (refer to green frame with arrow in the above screen).

To select the other measurement channels in the Compounds group, touch / click on the available channel labels: they are displayed in white on sky-blue background. Touch / click on  to validate this selection and close the window.



To select the channels of the other groups, switch  to  of any other Voltage, Sensor, Calculation or Analog. Input fields. Then, touch / click on the channel labels to be selected: they are displayed in white on sky-blue background. Then, touch / click on  to validate this selection and close the window.

The key  closes the window without validating.

It is possible to select all the available channels as shown below. Once they are selected, the channels no more appear in the right frame avoiding selection of the same channel twice.





Details of the various measurement channel groups are shown below:

- Voltage measurement channel selection:





- Sensor measurement channel selection:






- Analog. Input measurement channel selection:



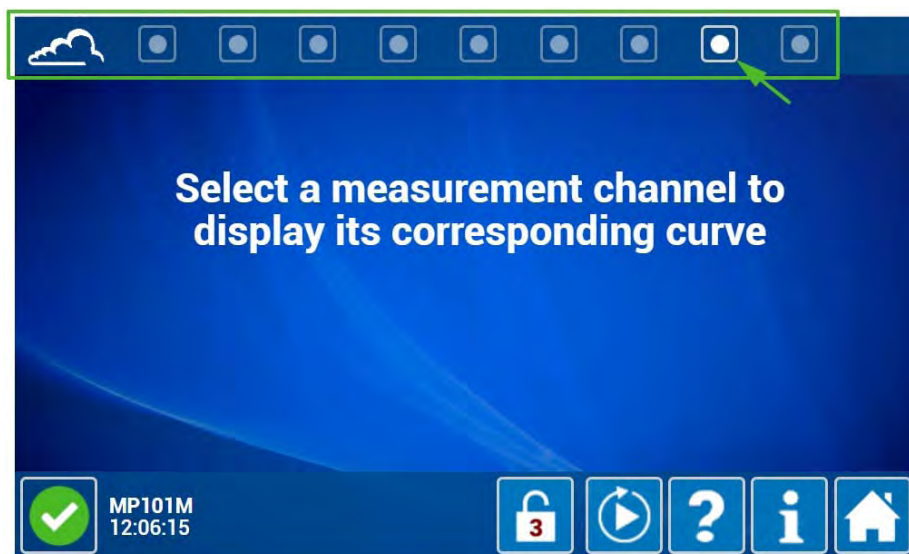
The selected measurement channels are placed in the numbered fields (refer to frame with arrow in the screen below). Touch / click on  in the right side of the screen to validate the whole selection.  is used to quit the screen without validating.



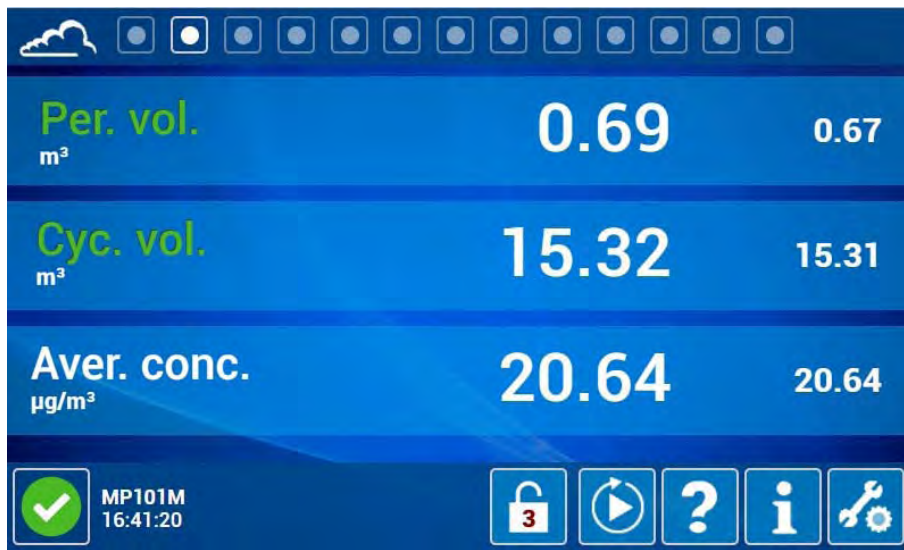
Touch / click on  to view the measurement channel display in the home page : only three measurement channels are displayed per page. To display all of the selected channels, the GUI (graphic user interface) adds as many pages as necessary. These additional pages are symbolized by the buttons  and  displayed at the screen top (refer to frame with arrow). The user touches / clicks on these buttons to display pages successively.

### 3.4.1.3. Real time graph display

The user views the measurement channel graphs by touching / clicking on the next-to-last button in the top screen browsing bar (refer to frame with arrow). If no channel selected, the below message is displayed:




Touch / click on the channel names to be selected: they turn green, as shown in the screen below:



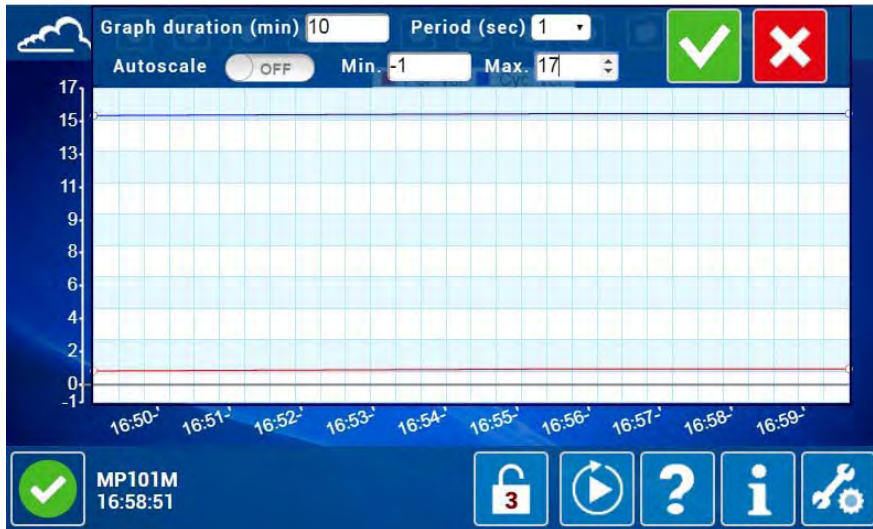
Go back to the next-to-last page to view the corresponding curve display. By default, the Y-scale setting is automatic, and thus is adjusted in real time to allow each selected channel curve to be displayed inside the screen.


A maximum of six curves can be displayed simultaneously.

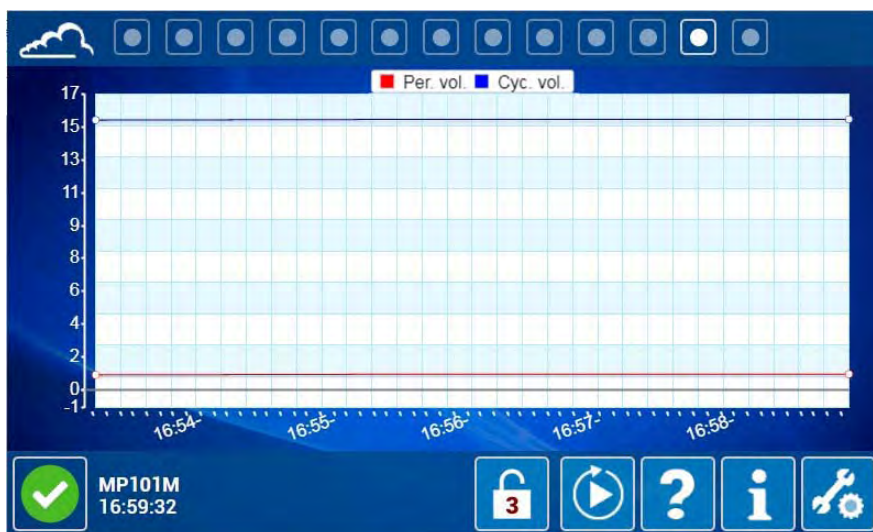


To configure the Y-axis, the user touches / clicks in the current graph: the modifiable parameters are displayed at screen top. Then the user switches OFF the Autoscale field, sets the minimum and maximum Y-axis scale values (-1 and 17 in the example on next page), and validates the modifications with .





To activate the zoom function, the user selects the area to zoom by touching / clicking on it, or using the mouse pointer: it greys the selected area. The user validates the selection by touching / clicking on  to display the zoomed graph.

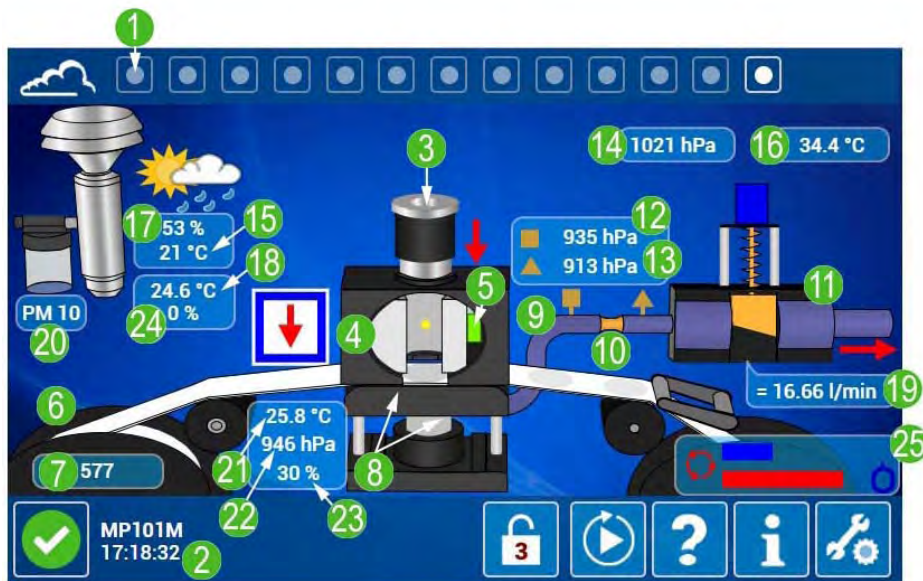


The user exits the zoomed graph by touching / clicking again in the screen.

### 3.4.1.4. Analyzer synoptic diagram

The user views the synoptic diagram by touching / clicking on the last button in the top screen browsing bar. This screen displays the entire fluid circuit and the significant operating parameter values.

- (1) touch /click on this button to display the first three channel values, with the corresponding units.
- (2) analyzer hour.
- (3) air sample inlet.
- (4) source holder assembly, (5) radioactive source: diagrammed in this position, the source is in sampling position, it means that the analyzer is not into measurement mode.
- (6) reel of filter ribbon, (7) this value gives, in spot number, the remaining analyzer autonomy.
- (8) plate block and Geiger Muller counter, (9) fluid circuit diagram, (10) critical orifice, (11) control valve assembly, (12) P1 pressure upstream the critical orifice, (13) P2 pressure downstream the critical orifice: when the analyzer starts up, P1 and P2 are at atmospheric pressure.
- (14) atmospheric pressure, (15) atmospheric temperature, (16) internal temperature of the analyzer, (17) relative atmospheric humidity, (18) temperature of the sampling tube (RST line).
- (19) flow rate. In measurement mode, the « = » indicates that the measured flow rate value is within the tolerances.
- (20) analyzer sampling head. This data is configurable in the « *Advanced analyzer configuration* » screen, page 2.
- (21) values given by the temperature, (22) pressure and (23) hygrometry « GM sensors » located under the filter.
- (24) percentage of heating power of the sampling line.



(25) touch /click here to display the window giving the current cycle data. This window allows to view the current cycle and period status.

**CYCLE** field: the figure into brackets reminds the cycle duration. This duration is configurable in the MEASUREMENT MODE / Cycles field, of the « *Advanced analyzer configuration* » screen, page 1. The number on the right indicates the current cycle number relative to the general start.

**START** field: indicates date and hour of current cycle start.

**END** field: indicates date and hour of pump stop and current cycle end.

**PERIOD** field: the figure into brackets reminds the period duration. This duration is configurable in the MEASUREMENT MODE / Periods field, of the « *Advanced analyzer configuration* » screen, page 1. The number on the right indicates the current period number relative to the cycle start.

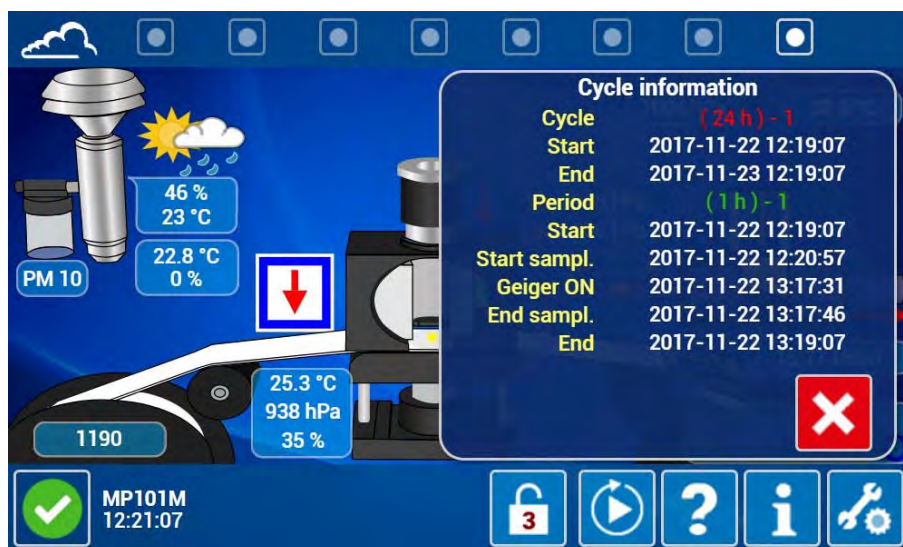
**START** field: indicates date and hour of the current period start.


**START SAMPL.** field: indicates date and hour of pump start for the current period.

**GEIGER ON** field: indicate date and hour of counting start (GM counter powered ON) of the current period.

**END SAMPL.** field: indicates date and hour of pump stop for the current period.


**END** field: indicates date and hour of current period end and new concentration value display.

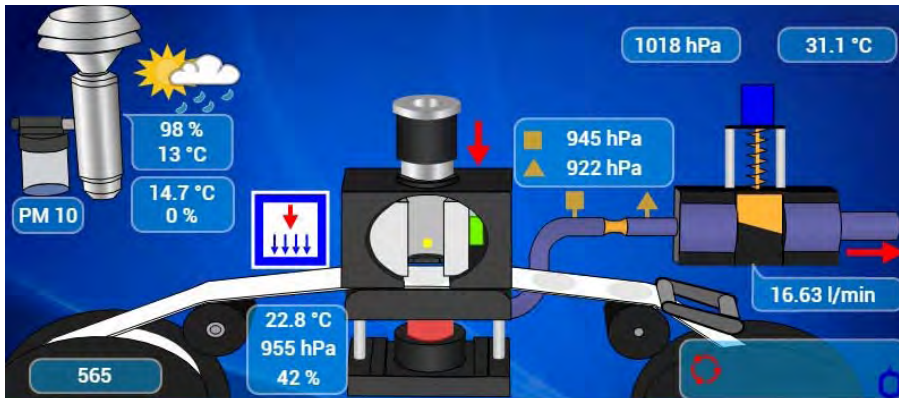



 closes the window.

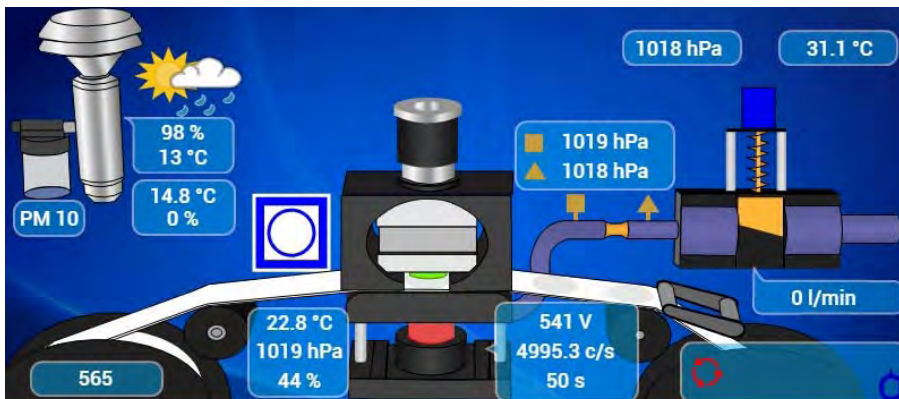



**Sequence series description when the system starts up (touch/ click on  then on ):**

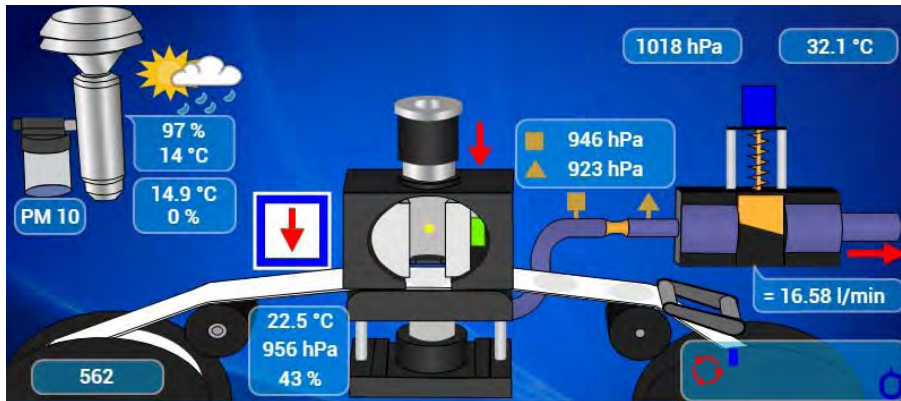
- 1 – The plate assembly goes down.
- 2 – The filter paper is moved for a distance equivalent to one step, and is placed under the filter holder.
- 3 – The plate assembly is placed in high position, under the filter, in order to ensure that there is no leaks between the filter and the aspiration channel.
- 4 – The source holder cylinder is placed in « aspiration » position.
- 5 – The pump starts into « Drying paper » mode symbolized by the icon  of the screen below.




- 6 – The power supply of the Geiger Muller counter is activated.
- 7 – The pump stops.
- 8 – The source holder cylinder is placed in « Counting » position symbolized by the « Blank counting » icon  of the screen below. The other measurement messages displayed are the following: countdown time, power supply of Geiger Muller counter, count stated in count per second (cp/s).

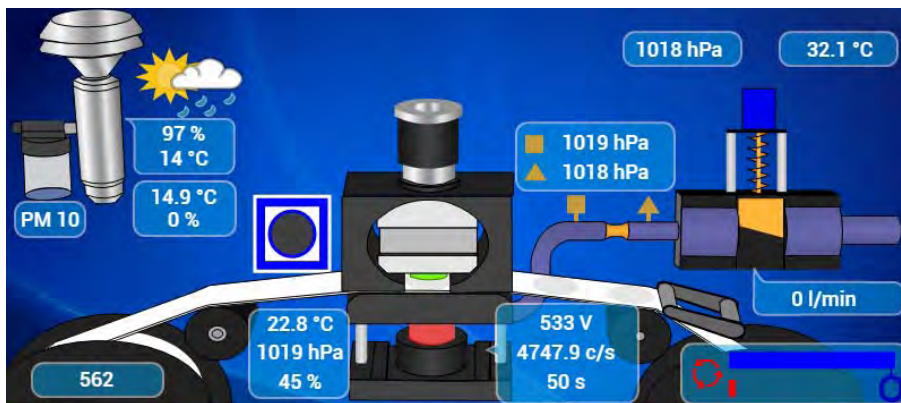




- 9 – At the end of the « Blank counting », the source holder cylinder is placed again into aspiration position.
- 10 – The pump starts, and the sampling begins, symbolized by the sampling icon  of the screen below. The instrument takes the sample during the programmed duration, at the setting flow rate of 1 m<sup>3</sup>/h.



11 – the pump stops, sampling is finished.

12 – the source-holder cylinder is placed in « counting » position and performs the measurement symbolized by the icon . See the « measurement » screen below.




At any time, the user can interrupt the sampling and the current measurement by touching / clicking on  the on .

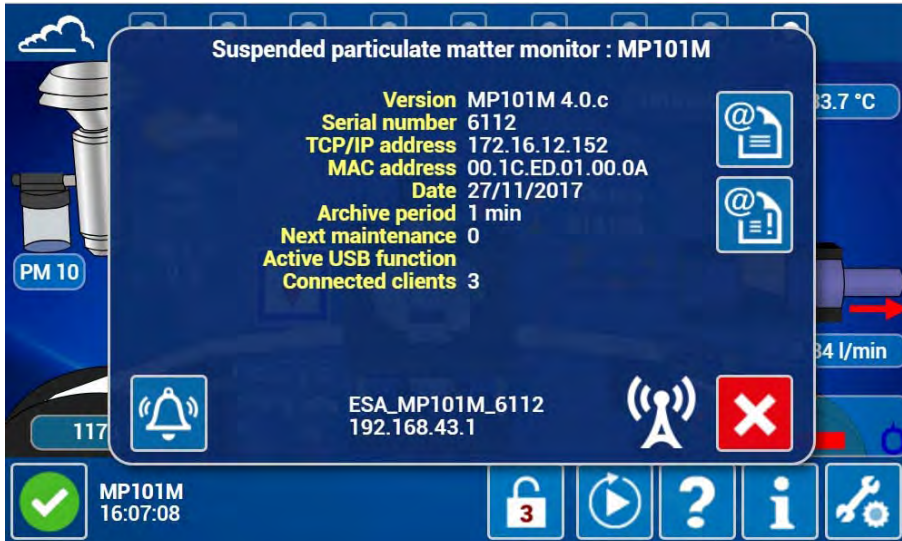
**NOTE :** Various start types are configurable in the START field of the « *Advanced analyzer configuration* » screen, first page:

- 1 – In case of **Immediate** start, the analyzer starts immediately.
- 2 – In case of **Delayed** start, the analyzer waits for the programmed start hour.
- 3 – In case of **External synchronization** start, the analyzer waits for an external dry contact closes.
- 4 – In case of **Hourly resynchronization** start, the analyzer starts immediately and is resynchronized when it reaches the programmed hour.








### 3.4.1.5. Information panel



The information panel is displayed by touching / clicking on  in the bottom browsing bar. It allows the user to view the software version, analyzer serial number, TCP/IP analyzer address, current date programmed in the analyzer, memorization period for data archiving, remaining days up to the next maintenance, if YES or NO an USB function is active on the analyzer, number of clients connected.





#### Definitions of icons and buttons specific to the information panel

	: Indicates that the analyzer is equipped with a WIFI key to connect remotely from a tablet or smartphone. ESA_MP101M_6112 and 172.16.12.152 are WIFI TCP/IP identifier and address required for connection.
	: Is used to email analyzer status (mux signal values).
	: Is used to email recorded events (history)
	: Sounds signal to locate the corresponding analyzer when not fitted with screen.
	: Closes the information panel.

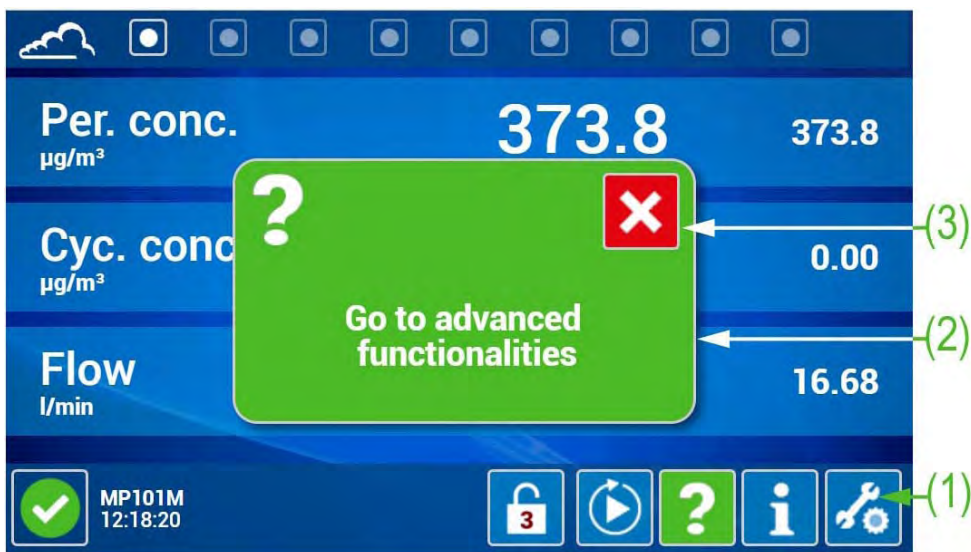
### 3.4.1.6. Contextual help operation

The user activates the contextual help by touching / clicking on  which turns green . Then, the user touches / clicks on button (e.g. 1) or screen part to know the operation or use: a window (2) opens to give the desired information.

The contextual help window closes by touching / clicking on  (3).


**NOTE :** The contextual help is disabled by touching / clicking on  again.

See the example below:



(1) Button selected to know the operation or use, (2) message giving the desired information, (3) button used to close the contextual help window.

### 3.4.2. ADVANCED FUNCTIONS

The user accesses the advanced function access screen by touching / clicking on .



The advanced functions can only be accessed by allowed users with a password. As indicated in page 3–15, three hierarchical password levels are available: User, Advanced, and Expert.


All the advanced functions available for Expert users are described below.

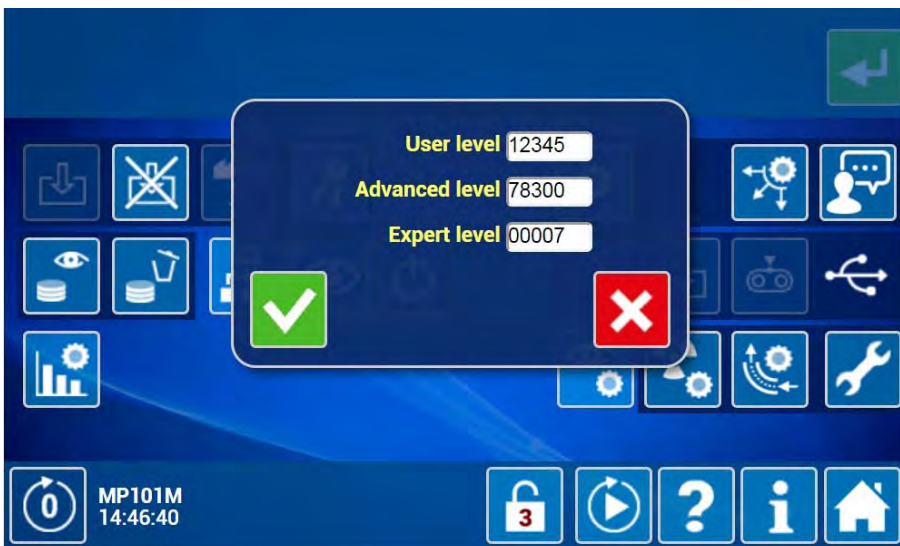
#### 3.4.2.1. Password management

The user touches / double-clicks on  to open this window.


The passwords indicated in the screenshot below are the factory passwords available in the analyzer on delivery. Upon initial startup, it is recommended to modify these factory passwords (refer to page 3–15).

The user modifies the password fields by filling-in them and validating entry with .


 closes the window without validating the modifications.



### 3.4.2.2. General configuration (Address, Protocol, Measurement channels...)

The user accesses this screen by touching / double clicking on . This button icon remains displayed at the top right side of the screen.

This screen allows configuration of addresses and protocols required for communication, and measurement channels configuration.

: This button is displayed when the analyzer is connected to a PC or a tablet. By touching / clicking on it, the user updates the analyzer date and hour with the current date and hour of the PC or the tablet.

DATE and TIME fields: they are used to set the internal date and hour of the analyzer.

ARCHIVE PERIOD field: it is used to set the period of the stored averages (archives) of the analyzer.

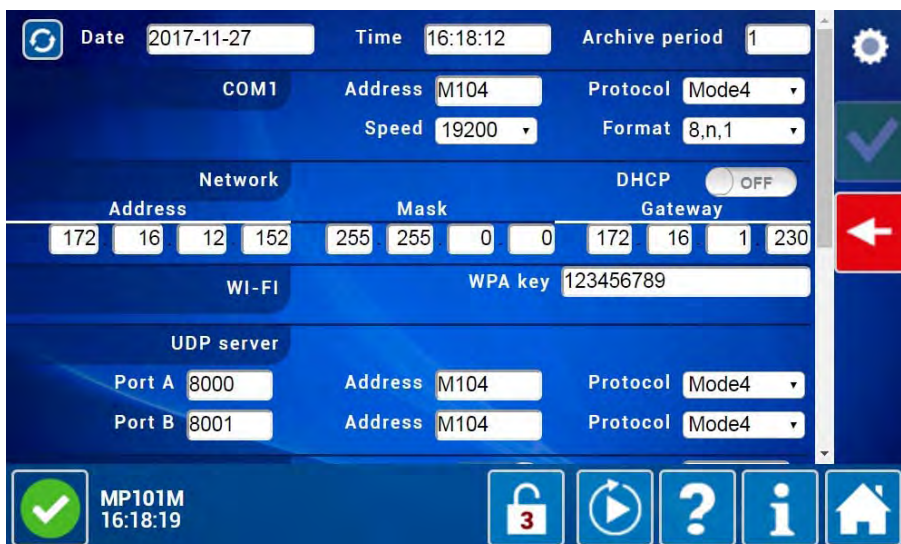
NETWORK section: allows the automatic network configuration.

- DHCP field ON: allows connecting the analyzer to a TCP/IP network address managed by a DHCP server.
- DHCP field OFF: allows displaying the ADDRESS, MASK and GATEWAY fields. Thus, the user defines the TCP / IP address, gateway and mask required for connection.

WI-FI section: the WPA KEY field is used to identify the key when it is connected on the unit.

UDP SERVER section: allows configuration of the two available UDP ports, Port A and Port B.

- PORT A and PORT B number field: can be fixed within the range 1000 to 9999.
- ADDRESS field: is only used for Mode4 (four alphanumeric characters) and JBUS (number 0000 to 0255). By default, the analyzer name written on four characters: M104.
- PROTOCOL field: Mode 4, PRN, JBUS and BAYERN are available.



The screenshot displays the configuration interface for the MP101M analyzer. At the top, there is a refresh button (circular arrow) and fields for Date (2017-11-27), Time (16:18:12), and Archive period (1). Below this is the COM1 section with fields for Address (M104), Protocol (Mode4), Speed (19200), and Format (8,n,1). The Network section includes a DHCP toggle set to OFF, and fields for Address (172.16.12.152), Mask (255.255.0.0), and Gateway (172.16.1.230). The WI-FI section has a WPA key field (123456789). The UDP server section shows Port A (8000) and Port B (8001), both with Address (M104) and Protocol (Mode4) fields. A bottom status bar shows 'MP101M 16:18:19' and navigation icons for lock, play, help, info, and home.

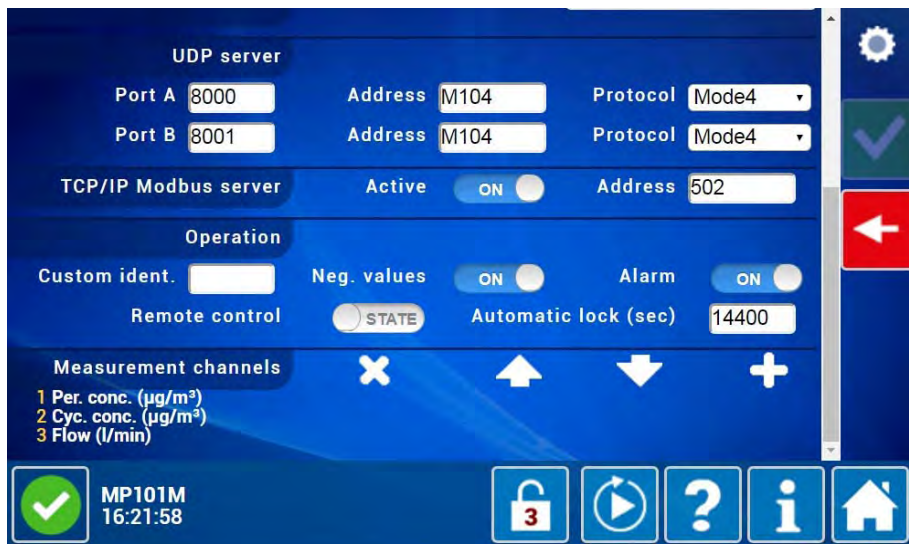


TCP/IP MODBUS SERVER section: allows configuration of this communication protocol.

OPERATION section:

- CUSTOM IDENT. field: allows entering the identification user code.
- NEG. VALUES field: negative values are allowed when this field is ON, and not allowed when it is OFF.
- ALARM field: alarm management is activated when this field is ON, and deactivated when it is OFF.
- REMOTE CONTROL field: allows configuring the remote control logic inputs.
- AUTOMATIC LOCK (SEC) field: it enables the user to set the duration in seconds between two password entries.

MEASUREMENT CHANNEL section: allows configuration of the measurement channel display.




**Tableau 3–1 – Measurement channel list of MP101M (CPM option excepted)  
with indication of the associated options.**

**The recommended measurement channels for diagnostic support are in grey background.**

Cha.	Display	Meaning	Option	Units	Details
1	Per. conc.	Periodical concentration		µg/m <sup>3</sup>	Period = time interval between two intermediate measurements on the same spot. Typical period duration = 1 or 2 hours.
2	Cyc. conc.	Cyclical concentration		µg/m <sup>3</sup>	Cycle = Total sampling duration on the same spot. Typical cycle duration = 24h (= regulatory measure duration).
3	Flow	Flow rate		L/min	Nominal flow = 1 m <sup>3</sup> /h = 16.67 L/min.
4	Per. vol.	Periodical volume		m <sup>3</sup>	
5	Cyc. vol.	Cyclical volume		m <sup>3</sup>	
6	Aver. conc	Average concentration		µg/m <sup>3</sup>	Refer to chapter 2.
7	Floating aver.	Floating average		µg/m <sup>3</sup>	Refer to chapter 2.
8	Head heat.	Head heating	RST	%	Heating control indicator of RST line. Used to check its operation.
9	Dew point ext.	Outside dew point	RST	°C	Ambient air dew point. Condensation forming indication
10	Dew point GM	GM dew point		°C	Air dew point near GM detector.
11	NRA count.	NRA counting		c/s	Count number measured without source at each period end (if "NRA" function activated).
12	Contam.	Contamination		c/s	Count number measured without source at each cycle beginning (if "Contamination" function activated).
13	Auto. cal.	Automatic calibration	Auto span	%	Difference in % between the last two calibration coefficients measured. Allows detecting a drift.
14	Mass cont.	Auto. Mass test	Auto span	%	Difference in % between the mass test result and the span value. Allows detecting a drift
15	Gauge cont.	Auto. Gauge test	Auto span	µg/cm <sup>2</sup>	Zero measurement. Allows detecting GM detector dysfunction.
16	GND	GND		V	
17	+5V	+5V		V	
18	+15V	+15V		V	
19	-15V	-15V		V	
20	HV Geiger	High Voltage Geiger		V	
21	Ref. 2.5V	2.5V reference		V	
22	Ref. RH	Humidity sensor reference	RST	V	
23	Internal T	Internal temperature		°C	Temperature measured inside the analyzer.
24	Up pr.	Upstream pressure		mbar	P1 pressure upstream the diaphragm (refer to chapter 2).
25	Down pr.	Downstream pressure		mbar	P2 pressure downstream the diaphragm (refer to chapter 2).
26	Atm. pr.	Atmospheric pressure		mbar	Atmospheric pressure measured inside the analyzer.
27	GM T.	GM temperature		°C	Temperature measured on the « GM sensor » board located near the GM detector.
28	GM hydr.	GM hygrometry		%	Relative hygrometry measured on the « GM sensor » board located near the GM detector
29	GM pr.	GM pressure		mbar	Pressure measured on the « GM sensor » board located near the GM detector.
30	Rel. hydr.	Relative hygrometry	RST	%	Relative hygrometry measured by the meteorological RST line sensor.
31	Atmo. T.	Atmospheric temperature	RST	°C	Atmospheric temperature measured by the meteorological RST line sensor.
32	Head T.	Head temperature	RST	°C	Temperature measured inside the RST line pipe.
33	Ref. A/D	A/D reference		V	

### 3.4.2.3. Automatic function configuration

The user accesses this screen by touching / double-clicking on . This button icon remains displayed at the top right side of the screen.

This screen is available when the AUTOMATIC SPAN field is ON in the first page of the « *Advanced analyzer configuration* » screen. It allows configuring the automatic calibration, the mass test, and the gauge test. It is possible to activate the three functions at the same time by setting the AUTOMATIC SPAN field to ON for the three functions in the screen below.



The function activation (ON) allows to set its frequency expressed in number of cycles.

The automatic calibration, the mass test and the gauge test can be done on an average of several measurements: the RECURRENCE field is used to set this number of measurements. A recurrence of 3 is recommended.




#### Multiple functions ON:

If two or three functions are ON, this parameter activation authorizes them to be carried out successively on the same cycle, in the following order of priority: (1) automatic calibration, (2) mass test, (3) gauge test.

#### Multiple functions OFF:

When this parameter is disabled, only one function per cycle is allowed.

#### 3.4.2.4. Language selection

The user displays this window by touching / double-clicking on .


This window allows changing the analyzer language: the available languages are Chinese, English, French and German.

The red frame around the flag indicates the language in use. The user touches/clicks-on the other flag to select the desired language and close the window. Then, the « *Language selection* » message is displayed at the top of the screen when English is selected, and « *Choix de la langue* » when French is selected.







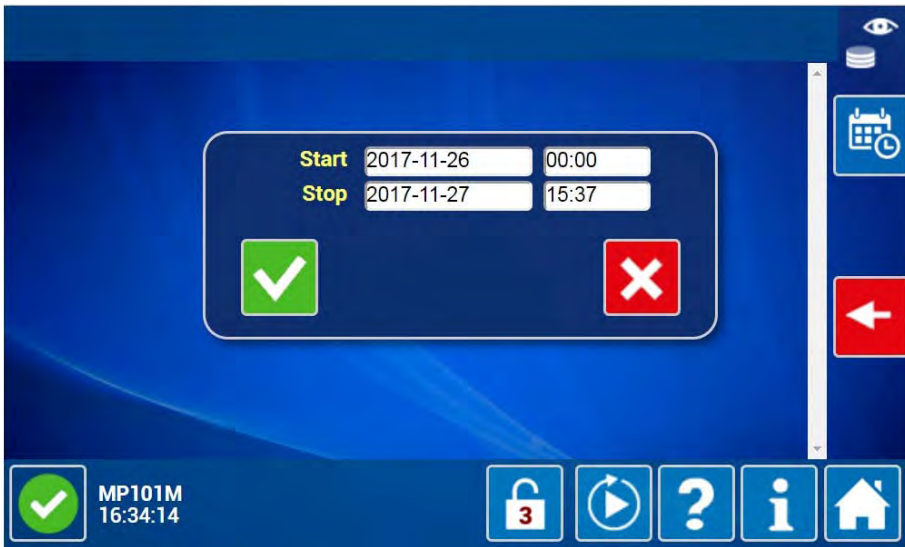
3.4.2.5. Find and display recorded averages



The user accesses this screen by touching / double-clicking on . This button icon remains displayed at the top right side of the screen.

This screen allows setting the recorded average period the user wants to watch, and displays the data for the measurement channels previously selected.


The user touches/clicks on the Start and/or Stop fields to select or modify the recorded averages start and end periods, then he touches / clicks on  to validate, close the window and display the data screen.

 closes the window without selection validation.


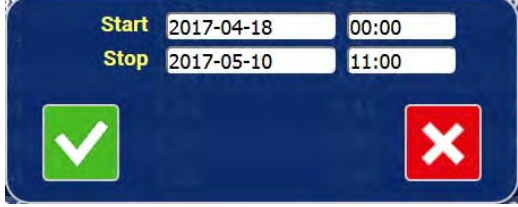



The user touches/ clicks on  to display the next measurement channel data, and on  to display the previous measurement channel data.






 allows user to quit the screen and return to the advanced function access screen.


**Button definitions specific to this screen:**

	<p>: Opens the window to select another period.</p> 
	<p>: Allows exporting the displayed data to a TXT file.</p>

**Icon functions displayed near the measurements**


	<p>: indicates an average stored with an alarm status. Alarm details are displayed by touching / clicking on this icon.</p>
	<p>: indicates an average stored with a control status. Control details are displayed by touching / clicking on this icon.</p>
	<p>: indicates an average stored with a calibration status. Calibration details (zero, span) are displayed by touching / clicking on this icon.</p>


**3.4.2.6. Delete all recorded averages**

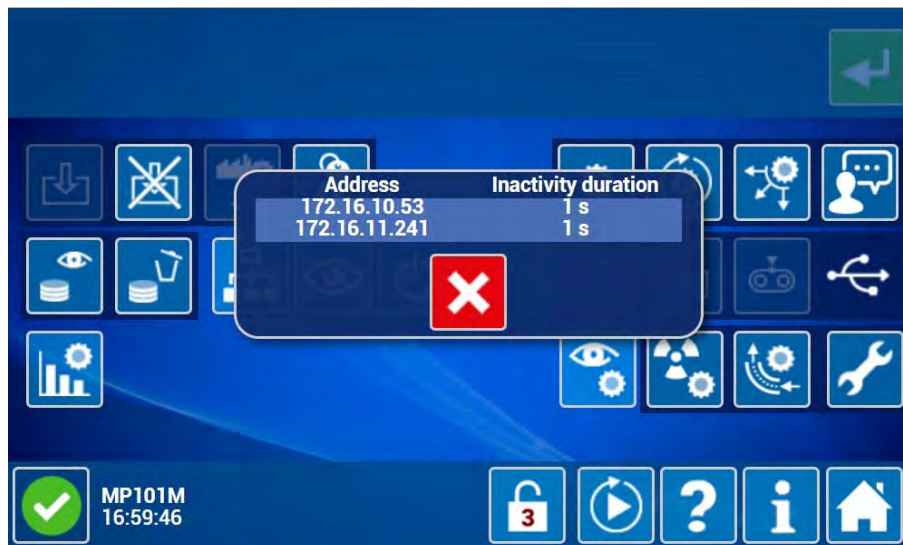
The user deletes all the recorded averages by touching / double-clicking on .

**WARNING: this action is irreversible.**


**3.4.2.7. List of connected clients**

The user displays this window by touching / double-clicking on . It displays the IP addresses and inactivity duration of the connected clients.

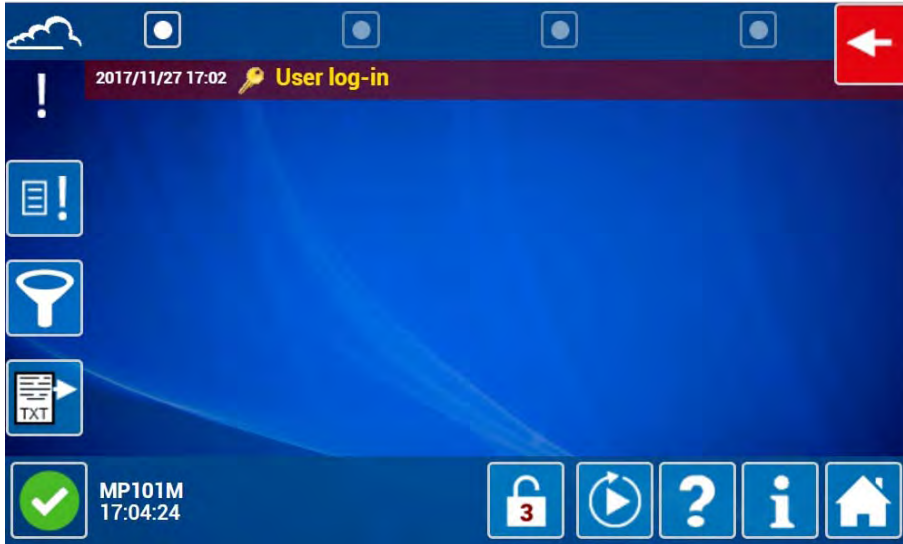
 allows user to close this window.




3.4.2.8. Diagnostic functions (alarm, input / output, mux...)




The user accesses this screen by touching / double-clicking on .

This screen consists of many pages: the first page lists the current alarms and significant events, the second page displays the electric signal values and remote control inputs/outputs, the third page allows to pilot the analyzer controls, and the fourth page offers a diagnostic help.



 allows user to quit the screen and return to the advanced function access screen.

**Button definitions specific to this first page:**

	: Displays or hides all the archived events.
	: Displays or hides the simple events. Acts as a filter.
	: Exports the displayed data as TXT file.

The second page gives the analyzer signal values:









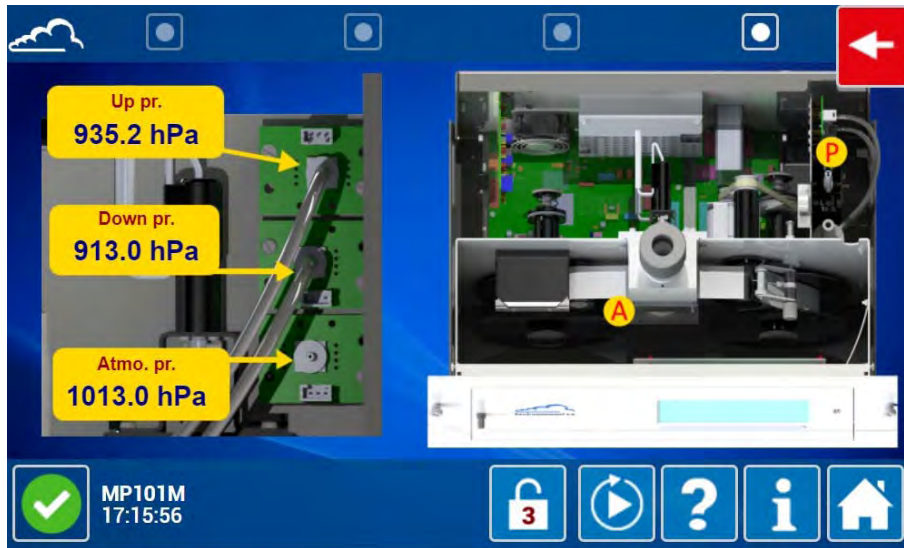
The third page gives the control status, the list of components and their status when they are detected when the analyzer starts. The ON / OFF buttons are used to check that the corresponding elements are working properly. When the user leaves the screen, items return to their standard status.





Help to resolve the detected alarms:


When an alarm triggers, the alarm icon  is displayed at the bottom left side of the screen. The user touches/clicks-on to access the diagnostic function first page displaying the current alarm and significant event list, as shown below. By clicking / touching the icon  of the alarm field indicating the fault nature and its triggering time, the user accesses the page 4 of the diagnostics function.






The Diagnostic function page 4 allows to view the exceeding values of the alarm thresholds and to locate the faulty element in the internal view of the analyzer. The example shown below shows a pressure alarm due to a sensor fault, and located on the pressure sensor boards (click on the P point for displaying on the screen left-hand).





#### 3.4.2.9. Setting the analyzer in stand-by mode

The user activates stand-by mode by touching / double-clicking on  which becomes .


Stand-by mode is used to stop the pump while all the other controls remain in operation. The user reactivates the measurement mode by touching / double-clicking on .






When stand-by mode is activated, the status icon (in bottom left side of screen) is modified to . However, alarm or control status icons are priority. Consequently, if stand-by mode is activated while an alarm or a control is active, the alarm icon  or control icon  will remain displayed and the stand-by icon  will not be displayed. To verify if the measurement or stand-by status is active, the user checks if the button  is outlined in red or not in the advanced function access page.

#### 3.4.2.10. Setting the analyzer in maintenance mode


The user activates the maintenance mode by touching / double-clicking on  which becomes .

When the maintenance mode is activated, the recorded data is tagged with a status mark: Maintenance is indicated close to the concerned data.

The user reactivates the measurement mode by touching / double-clicking on .


When the maintenance mode is activated, the status icon (in bottom left side of screen) is modified to . However, alarm or control status icons are a priority. Consequently, if maintenance mode is activated while an alarm or a control is active, the alarm icon  or control icon  will remain displayed and the maintenance icon  will not be displayed. To verify if the measurement or maintenance status is active, the user checks if the button  is outlined in red or not in the advanced function access page.

### 3.4.2.11. Advanced analyzer configuration

The user accesses this screen by touching / double-clicking on . This button icon remains displayed at the top right side of the screen.

This screen allows configuration of the metrological parameters.

#### Page 1



The user accesses this page by touching / clicking on the first button  of the navigation bar at the screen top.

MEASUREMENT MODE section:

- CYCLES, PERIODS and COUNTING (S) fields : to configure the cycles, period and counting duration. It is recommended not to change the initial count setting set to 260 seconds.
- START field: to set the start type. The possible choices are: Immediate, Delayed, External sych., Hourly re-sync.

- NOTE :**
- 1 – In case of **Immediate** start, the analyzer starts immediately.
  - 2 – In case of **Delayed** start, the analyzer waits for the programmed start hour.
  - 3 – In case of **External synchronization** start, the analyzer waits for an external dry contact closes.
  - 4 – In case of **Hourly resynchronization** start, the analyzer starts immediately and is resynchronized when it reaches the programmed hour.

- STOP field: to program the stop type. The possible choices are: Manual, Hourly Synchro., Number of cycles.

- NOTE :**
- 1 – In case of **Manual** stop, the measurement stops by touching / clicking on  then on .
  - 2 – In case of stop with **Hourly synchronization**, the user must define in the DATE/HOUR field the precise date and hour at which the unit will stop.
  - 3 – In case of stop with **Number of cycles**, the unit will stop at the end of the cycle number defined in the NUMBER OF CYCLMES fields.

BETA GAUGE section :

- K COEFF. and REF. GAUGE fields : they display the calibration coefficient automatically calculated at the end of the beta gauge calibration, and the reference gauge value. It is possible to manually change the calibration coefficient of the beta gauge, but it is better to perform a calibration in the specific « *Gauge calibration* » screen.

FLOW RATE section :

- K COEFF. K and SETPOINT fields : they display the calibration coefficient and the flow rate setpoint value. It is possible to manually change the flow rate calibration coefficient, but it is better to perform a calibration in the specific « *Flow calibration* » screen.

REEL section :

These fields are to be used after changing the filter reel.

- NB. SPOTS field: indicates the initial reel autonomy equal to 1200 spots. DO NOT modify it.
- COUNTER ON/OFF field: this field is normally OFF. After changing the reel, the user must set this field ON to initialize the autonomy counter to the spot number defined in the NB. SPOTS field, i.e. 1200. This value of 1200 is also reset in the synoptic screen, see (7) of paragraph 3.4.1.4.

The screenshot displays the MP101M control interface with the following settings in the REEL section:

- Measurement mode:** Cycles 24 h, Periods 1 h, Counting (s) 260
- Start:** Hourly re-sync., Date/Hour 2017-10-15 00:00
- Stop:** Manual
- Beta Gauge:** K coeff. 1, Ref. gauge ( $\mu\text{g}/\text{cm}^2$ ) 845
- Flow rate:** K coeff. 1,14599, Setpoint ( $\text{m}^3/\text{h}$ ) 1
- Reel:** Init. counter OFF, Nb. spots 1200

The interface also shows a status bar at the bottom with a green checkmark, the device name MP101M, the time 17:27:49, and several control icons (lock, play, help, info, home).

N.R.A. COUNTING section : parameters the natural radioactivity (N.R.A.) count. The user switches ON to activate the measurement, then programs the time during which the N.R.A. count will be performed. This test is performed before each periodic measurement without the source, i.e. before the source is placed in the « Counting » position. It therefore measures the natural radioactivity of the particles sampled on the filter.

When it is ON, a « NRA count. c/s » field is displayed in the compound group of the selection window of the measurement channels in the « *General configuration (Address, Protocol, Measurement channels...)* » screen. Once selected, this channel is displayed in one of the measurement channel screens of the standard functions.

CPM section : when a user installs a CPM module, it must switch ON the ACTIVE field.

CONTAMINATION TEST section : if ON, the unit will check for radioactive contamination at the beginning of each measurement cycle on a blank filter. This check will be done using the Geiger counter, without using the radioactive source. The user defines in the FREQUENCY (CYCLE) field the cycle number separating two successive contamination tests.

When it is ON, a « Comtam. c/s » field is displayed in the compound group of the selection window of the measurement channels in the « *General configuration (Address, Protocol, Measurement channels...)* » screen. Once selected, this channel is displayed in one of the measurement channel screens of the standard functions.

An alarm is activated if the count exceeds the value set in the DURATION field, i.e. 30 c/s in the screen below.

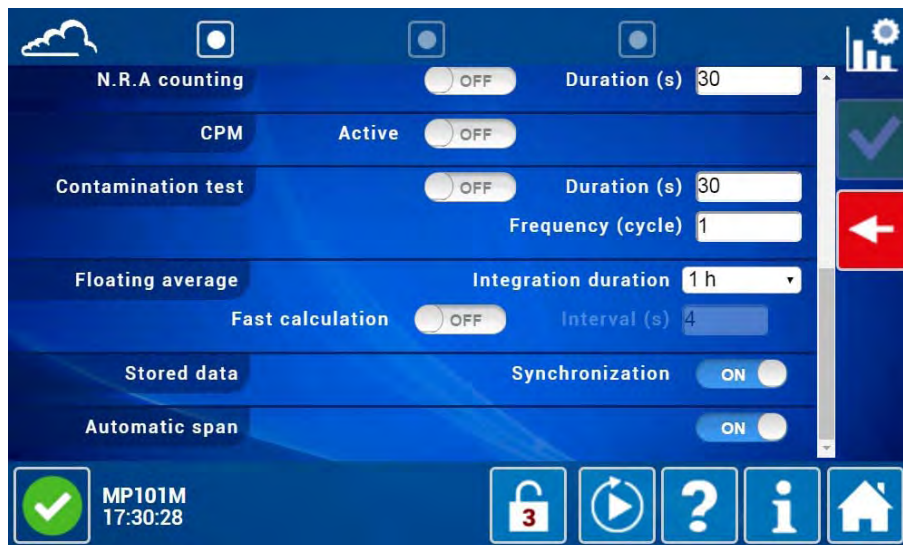


FLOATING AVERAGE section :


- INTEGRATION DURATION field: programming of the space time within which the measurements will be averaged,
- FAST CALCULATION field: if ON, it determines the time interval between 2 floating average calculations.

STORED DATA section: if ON, the unit synchronizes the data storage on the cycle and measurement periods.

AUTOMATIC SPAN section: the user must switch ON the field to enable the AUTOMATIC SPAN option when it is installed.



### Page 2:

The user accesses this page by touching / clicking on the second button  of the navigation bar at the screen top.

GM SENSORS section:

It allows to view and linearize the measurements of the 3 sensors of the GM sensors board: temperature sensors (GM TEMPERATURE field), hygrometry (GM HYGROMETRY field) and pressure (GM PRESSURE field). It is possible to linearize these sensors in case of deviation from reference sensors.

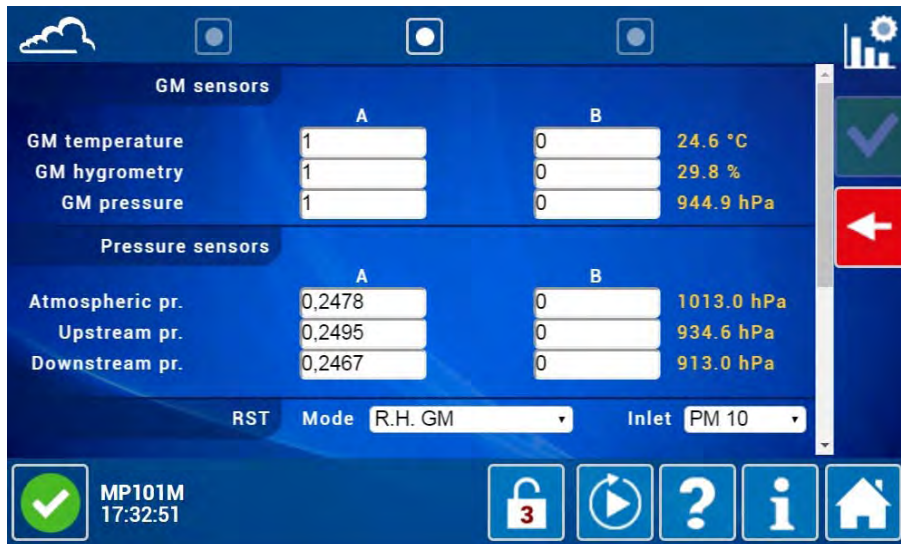
PRESSURE SENSORS section:

It allows to view and linearize the values of the three pressure sensors:

- Atmospheric pressure (ATMOSPHERIC PR. field),
- Upstream pressure (UPSTREAM PR. field),
- Downstream pressure (DOWNSTREAM PR. field).

Refer to Maintenance sheet 4.3.9 of Chapter 4 of this manual for procedure details.





RST section:

- MODE field: select the operating mode of the RST function:
  - OFF: deactivates the RST function and the sampling head heating.
  - ALWAYS: it corresponds to the previous HST mode (heated sampling tube). The sampling head is not regulated: it is permanently heated.
  - HEAD T. = f (Atmo T.): it allows to regulate the sampling head heating as a function of the atmospheric temperature.

When the hygrometry exceeds the threshold H programmed in the HEATING REGULATION section, the head heating is triggered to maintain it at the atmospheric temperature increased by the temperature offset programmed.

By default, the T. OFFSET and the HYGRO. THRESHOLD values are:

Particle size	PM10	PM2,5
H : Hygrometry threshold	60%	75%
T : Temperature offset	5°C	5°C

For the very wet sites, it is recommended to set H to 50% and T to 10 ° C.

- GM T. > f (D point) mode: this mode prevents any air condensation on the detector.

When the temperature of the Geiger-Muller sensor (measured near the filter and detector) is lower or equal to the dew point increased by the temperature offset programmed in the HEATING REGULATION section, the heating is triggered to regulate the Geiger-Muller sensor temperature at a value higher than the dew point + offset T °.

**NOTE :** The analyzer automatically calculates the dew point at the temperature and humidity conditions near the GM sensor.

- R.H. GM mode: this mode allows to maintain the relative humidity near the GM sensor lower than a modifiable hygrometry threshold.

**NOTE :** By default, the recommended hygrometry threshold value is 50%.

- HEAD field: defines the type of sampling head used. This parameter only affects the CPM data.

- ATMOSPHERIC T., HEAD T, RELATIVE HYGR. fields: they allow to linearize, according to the  $Ax + B$  calibration line, the temperature and relative humidity sensors. A and B are modifiable.

For each field, the A and B values are indicated in the columns, and the value of the sensor signal, expressed in the standard unit, is indicated in orange on the corresponding field line.


Relative hygrometry case: on the first installation, a test report is given with the meteo sensors of the RST line. It includes the "S" value which is the calibration line slope in mV /% RH, and the "Z" value, which is the offset to zero in mV. The user must input these S and Z values in the display.

S and Z are modified automatically when the user modifies A and B.

HEATING REGULATION section:

- HEAD HEATING field: if ON, it forces the head heating to test its correct functioning.

### Page 3:


The user accesses this page by touching / clicking on the third button  of the navigation bar at the screen top.

COMPOUND section: elements to be applied to the whole page.

- THRESHOLD 1 and THRESHOLD 2 fields: program the alarm threshold value for the corresponding compounds (measure channels). They are used to activate relays and alarm messages.
- UNIT fields: program the corresponding compound (measuring channels) unit.
- CONV COEFF fields: not applicable for particle measurement.
- OFFSET fields: program the offset for the corresponding compounds (measuring channels), this value is added to the measurement value.
- LINEARIZATION fields: allow to linearize the periodic and cyclic concentration measurements, in taking as reference another analyzer (reference defined according to the EN12341, EN14907, or USEPA standards).

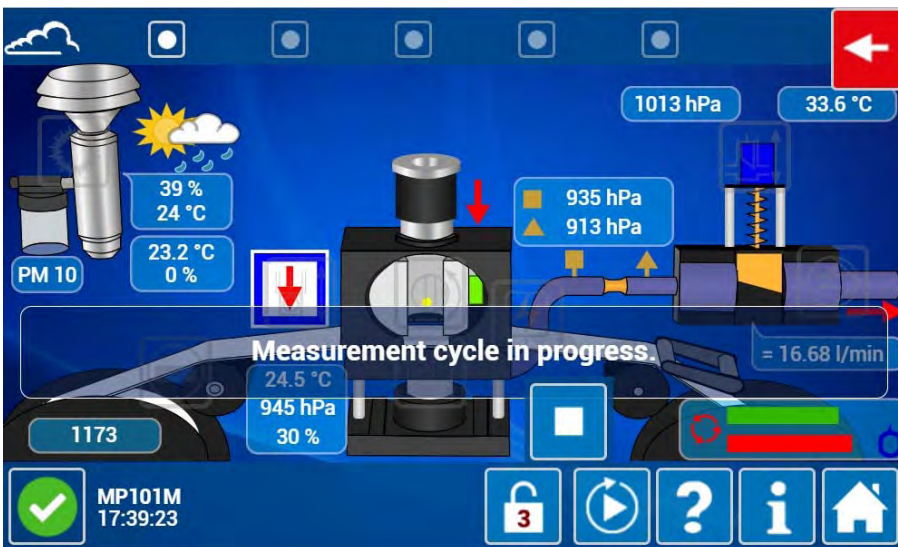




### 3.4.2.12. Hardware function tests

The user accesses this screen by touching / double-clicking on .

This screen is used to test the motor working, the high voltage power supply and the RST line heating (page 1), to carry out the gauge test (page 2), the mass test (page 3), the leak test (page 4), and the zero test (page 5).

These tests can only take place when the measurement is stopped.

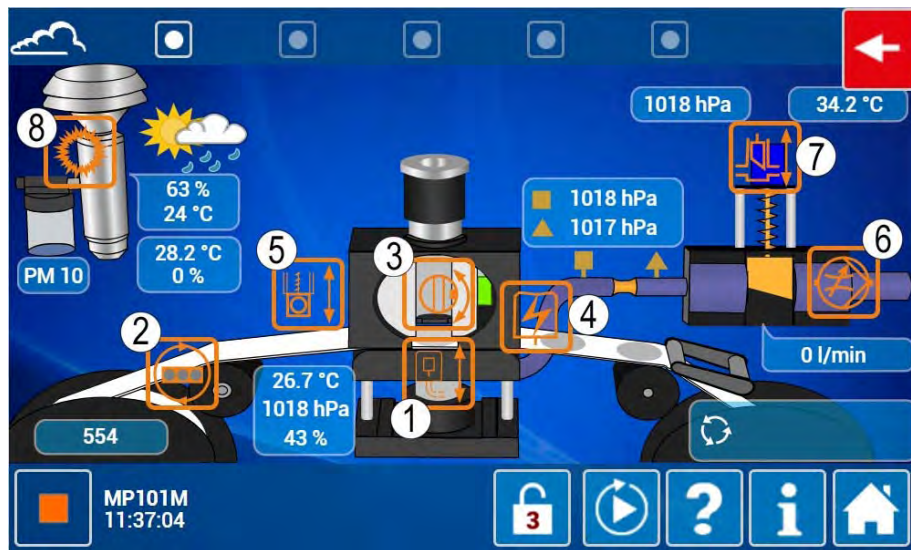


Therefore, the user must first stop the current measurement cycle by touching / clicking on  and then , and wait for the display below (page 1).



**Page 1: checking the motor working, the high voltage supply and the sampling line heating:**

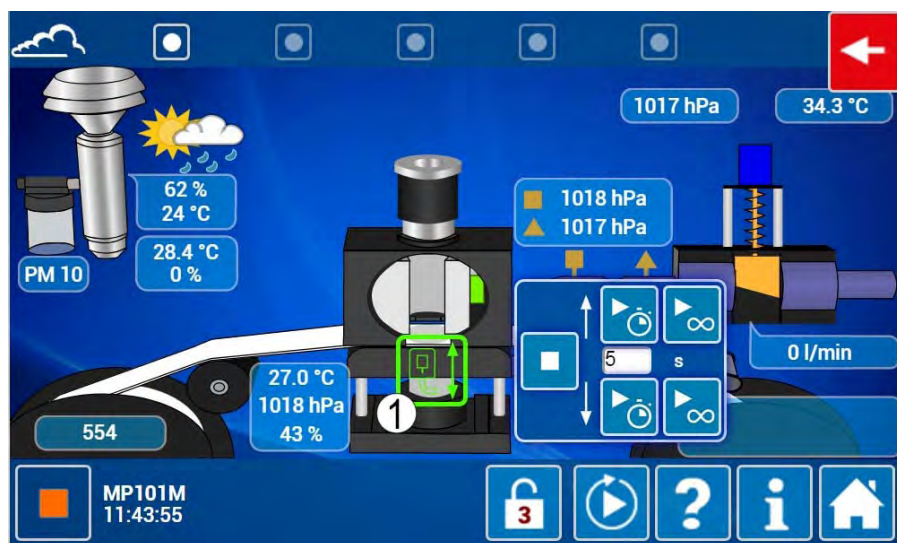
Click on the orange-surrounded buttons to open the windows allowing the tests.





**Test button definition:** (1) plate motor, (2) paper feed motor, (3) source holder motor, (4) high voltage supply test, (5) automatic span motor (optional test if reference gauge activated), (6) pump, (7) valve motor, (8) RST line heater.


**Plate motor operation:**

Touch / click on the button (1) which turns green and displays the test window in the screen below:



 operates the motor to bring up  $\uparrow$  or down  $\downarrow$  the plate during the time indicated in the frame (5 seconds in the screen above).

 operates the motor to bring up  $\uparrow$  or down  $\downarrow$  the plate without interruption.

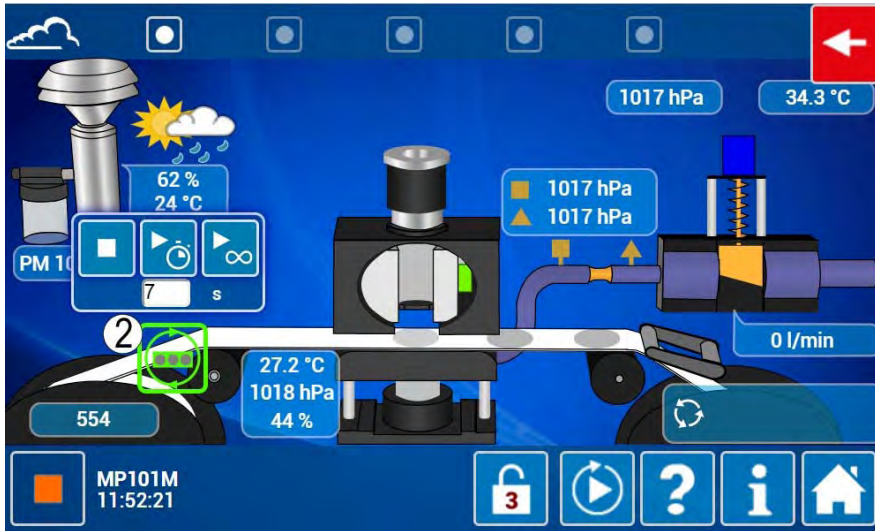
 stops the motor while operating.


Press down the green button (1) to return to the previous (original) screen.


Paper feed motor operation:


WARNING: this motor can only be operated when the plate is in down position.

Put the plate in down position and touch / click on the button (2) which turns green and displays the test window in the screen below:



 operates the motor to move on the paper for the time specified in the frame (7 seconds in the screen above).

 operates the motor to move on the paper without interruption.

 stops the motor while operating.




Press down the green button (2) to return to the previous (original) screen.




Source-holder motor operation


WARNING: it is better to operate this motor when the plate is in up position.

Put the plate in up position and touch / click on the button (3) which turns green and displays the test window in the screen below:



 operates the motor for the time specified in the frame (5 seconds in the screen above) to place the source in aspiration position  or in counting position .

 operates the motor without interruption to place the source in aspiration position  or in counting position .

 stops the motor while operating.

Press down the green button (3) to return to the previous (original) screen.

### High voltage supply test

WARNING: it is better to carry out this test when the source is in counting position, as diagrammed in the screen below.

Place the source in counting position and touch / click on the button (4) which turns green and displays the test window giving the high voltage value and the signal delivered by the detector (in counts per second).



### Motor operation of the automatic span (optional test if reference gauge activated)




This test button is available if the AUTOMATIC SPAN field is ON in the first page of the « *Advanced analyzer configuration* » screen.




WARNING: this motor must only be operated if the plate is in the down position.


Place the plate in the down position and touch / click on the button (5) which turns green and displays the test window in the screen below:





 operates the motor to place the reference gauge in withdraw  or measurement  position for the time indicated in the frame (10 seconds in the display above).

 operates the motor without interruption to place the reference gauge in withdraw  or measurement  position.

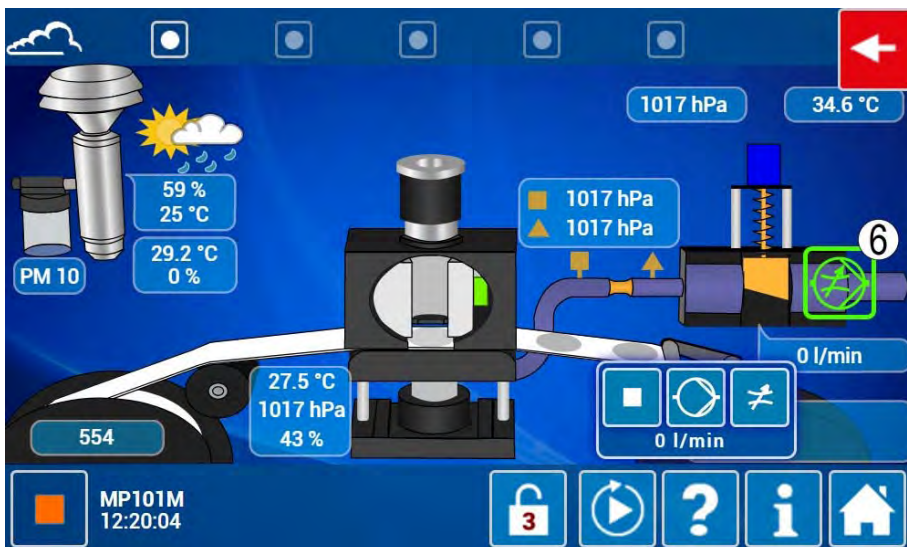
 stops the motor while operating.


Press down the green button (5) to return to the previous (original) screen.


Pump motor operation

WARNING: this motor must only be operated if the plate is in the up position.


Place the plate in up position and touch / click on the button (6) which turns green and displays the test window in the screen below:



 starts the pump motor.

 activates the pump regulation around the setpoint flow rate.

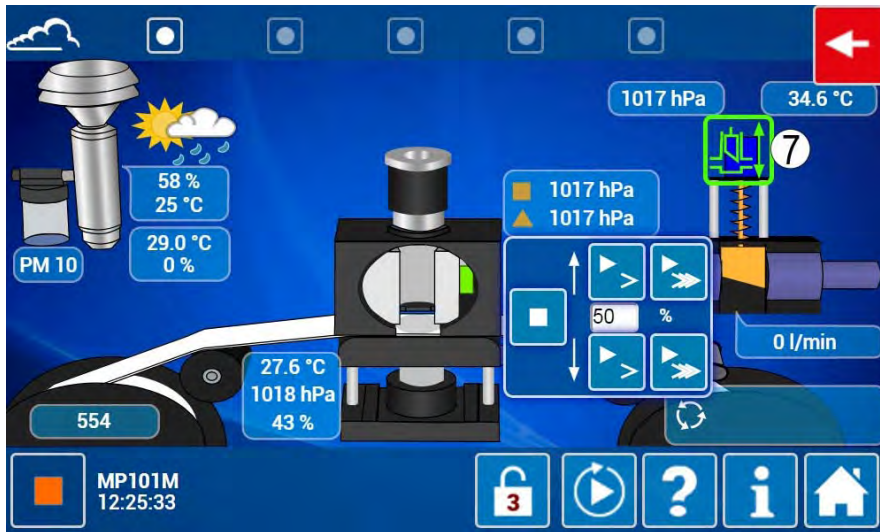




 stops the pump motor.



Press down the green button (6) to return to the previous (original) screen.


### Valve motor

Touch / click on the button (7) which turns green and displays the test window in the screen below:




 open  or closes  the valve at 50% of its stroke.

 open  or closes  the valve for its entire stroke.

 stops the valve motor.

### RST line heating


Touch / click on the button (8) which turns green and starts the RST line heating symbolized by . See the screen below.



(24) the heating power percentage of the sampling line passes from 0 to 100%.



(18) the sampling tube temperature increases.

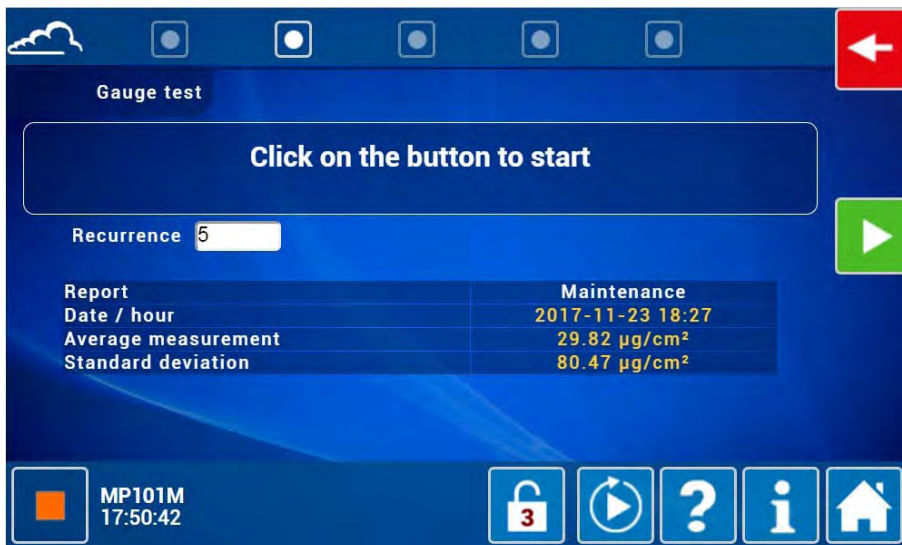
## Page 2 : Gauge test

The user accesses this page by touching / clicking on the second button  of the navigation bar at the screen top.

This test allows to check the detector noise. It consists in successively performing many measurements of zero and calculating their average and standard deviation.

When the analyzer is in measurement, the gauge test screen indicates the message « *Measurement cycle in progress* » and displays the report of the last gauge test.

To carry out a gauge test, the user must stop the current measurement cycle by touching / clicking on  and then  and wait for the below start screen display.



The recurrence is configurable and must be checked before starting the test. The recurrence is the number of times the device performs the double measurement (Blank-Measurement on blank filter). Therefore, it is involved in the average measurement calculation of the test report. By default, it is set to 5.


The gauge test is cyclic when the AUTOMATIC SPAN field is ON in the « *Advanced analyzer configuration* » screen, and in the « *Automatic function configuration* » screen, Cycle / Gauge test column.

**NOTE :** In this screen :

⇒ The recommended value for Recurrence is 3.

⇒ When the frequency value (cycle) is 1, the unit carries out a gauge test each cycle.

The gauge test is non cyclic when the AUTOMATIC SPAN field is OFF in the « *Advanced analyzer configuration* » screen. In this case, it is carried out manually during a maintenance.

Start the gauge test gauge by touching / clicking the button . The user follows the sequence of the different steps with the message displayed on the screen.

These steps are:

1 – Initialization

2 – Drying paper


- 3 – Geiger warm-up
- 4 – Blank 1/5
- 5 – Geiger rest
- 6 – Geiger warm-up
- 7 – Measure 1/5
- 8 – Geiger rest

Then the test resumes in 3 (3 - Geiger warm-up) until the number of blanks and blank filter measurements defined in the Recurrence field is performed. When the 5/5 measure is finished, the « Finalization » message is displayed and the report values are refreshed.

The test is successful if the average measurement value is between -10 and +10  $\mu\text{g} / \text{cm}^2$ .


The Blank 1/5 and Measure 1/5 are given below as example:



 stops the test at any time.




### Follow-up of the cyclic gauge test

During the cyclic gauge test, an orange icon  is displayed in the Synoptic screen allowing the user to follow-up the down count (3 - 2 - 1) of the recurrence defined in the « *Automatic function configuration* » screen. At the end of the cyclic gauge test, the test report is edited in the cyclic column window of the test gauge.





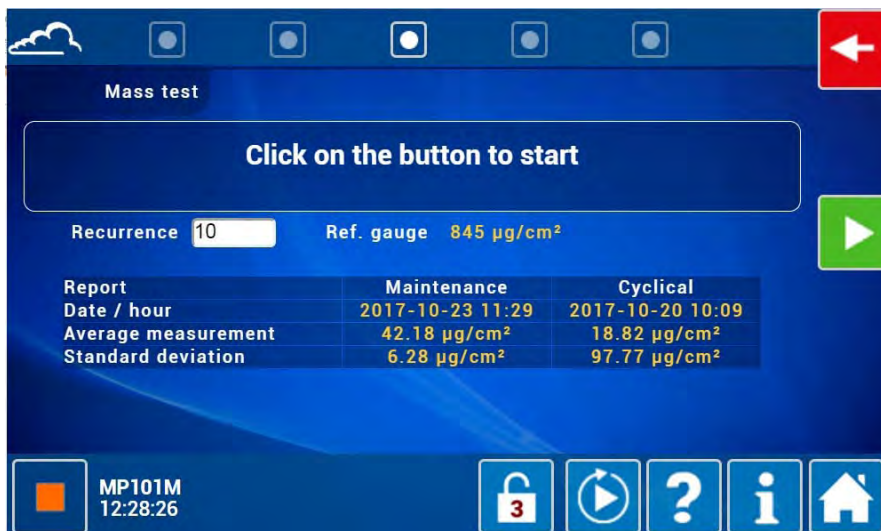
### Page 3: Mass test

The user accesses this page by touching / clicking on the third button  of the navigation bar at the screen top.

This test allows checking the mass measurement stability of a reference gauge. The test purpose is to calculate the measurement accuracy and repeatability on a reference gauge having a predefined mass. It consists in performing successively a zero measurement and many reference gauge measurements and calculating their average and standard deviation.

When the analyzer is in measurement, the mass test screen indicates the « *Measurement cycle in progress* » message and displays the report of the last manual and cyclic mass tests.

To perform a mass test, it is necessary to stop the current measurement cycle by touching / clicking on  then on  and wait for the start screen display as shown below.



The recurrence is configurable and must be checked before starting the test. The recurrence is the number of times the device performs the reference gauge measurement. Therefore, it is involved in the average measurement calculation of the test report. By default, it is set to 10.

The mass test is cyclic when the AUTOMATIC SPAN field is ON in the « *Advanced analyzer configuration* » screen and in the « *Automatic function configuration* » screen, Cycle/ Mass test column.


**NOTE :** In this screen :

⇒ The recommended value for the Recurrence is 3.

⇒ When the Frequency value (cycle) is 1, the unit performs a mass test at each cycle.

The mass test is non cyclic when the AUTOMATIC SPAN field is OFF in the « *Advanced analyzer configuration* » screen. In this case, it is performed manually during a maintenance.

Start the mass test by touching / clicking the button . The user follows the sequence of the different steps with the message displayed on the screen.

 stops the test at any time.

These steps are:

- 1 – Initialization
- 2 – Drying paper
- 3 – Geiger warm-up
- 4 – Blank (see screen below).
- 5 – Geiger rest

This screen displays the progress status of the Blank measurement (time count down and instantaneous count value).



Mass test 42 s


**Blank** **5189 c/s**

Recurrence  Ref. gauge **845 µg/cm<sup>2</sup>**

Report	Maintenance	Cyclical
Date / hour	2017-10-23 11:29	2017-10-20 10:09
Average measurement	42.18 µg/cm <sup>2</sup>	18.82 µg/cm <sup>2</sup>
Standard deviation	6.28 µg/cm <sup>2</sup>	97.77 µg/cm <sup>2</sup>

MP101M 12:30:51

- 6 – Insert reference gauge.

When the mass test is manual, the user must confirm the reference gauge presence by touching / clicking on .


- 7 – Reference gauge checking.
- 8 – Reference gauge inserted.

- 9 – Geiger warm-up
- 10 – Measure 1/10
- 11 – Geiger rest
- 12 – Geiger warm-up
- 13 – Measure 2/10
- 14 – Geiger rest
- 15 – Geiger warm-up



The measurement continues until reaching 10/10, repeating the two successive steps « Geiger rest » and « Geiger warm-up » between each measurement.

The Measure screen displays the last blank value, i. e. the blank performed at the test beginning, and the last measurement value. This value is refreshed after each new measurement.

When the 10/10 measure is finished, the screen indicates « Geiger rest », then « Pull out reference gauge ». When the mass test is manual, the user must confirm the pull out of the reference gauge by touching / clicking on  to go to the last two steps:

- n-1 – Reference gauge checking
- n – Finalization.

The screen is refreshed when the new manual test report is edited.


### **Following-up of the cyclic mass test**

During the cyclic mass test, a yellow icon  is displayed in the Synoptic screen allowing the user to follow the recurrence count down (3 - 2 - 1) defined in the « *Automatic function configuration* » screen. At the end of the cyclic mass test, the test report is edited in the cyclic column window of the mass test.







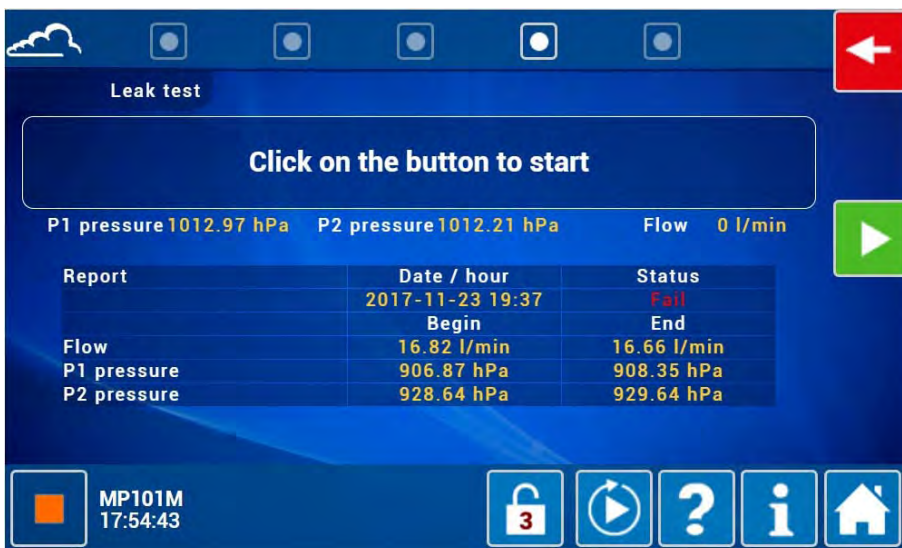
### Page 4: Leak test

The user accesses this page by touching / clicking on the fourth button  of the navigation bar at the screen top.

This test allows to check the leaks of the fluid system between the sample inlet and the pump. The purpose of this test is to check that in the presence of the shutter placed on the sample inlet, the flow rate is lower than 5 liters / minute and the P1 and P2 pressures lower than 250 mbar.

When the analyzer is in measurement, the leak test screen indicates the « *Measurement cycle in progress* » message and displays the last leak test report.

To perform a leak test, it is necessary to stop the current measurement cycle by touching / clicking on  then  and wait for the start screen display as shown below.




Start the leak test by touching / clicking the button . The user follows the sequence of the different steps with the message displayed on the screen.

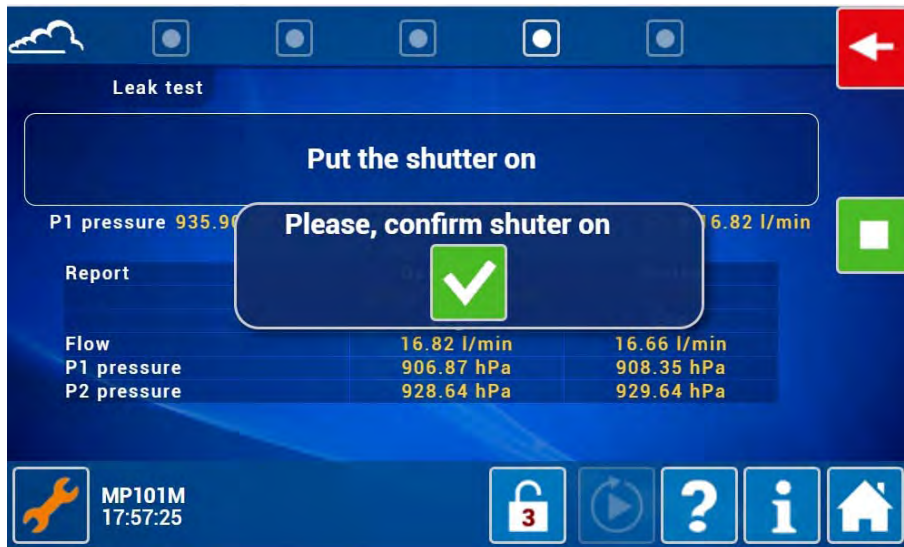
These steps are:

- 1 – Initialization
- 2 – Waiting refer. flowrate




The unit starts the pump and the regulation to reach the setpoint flow rate and wait for stabilization. When the flow rate value is close to 16.67 l / min, the test goes on to the next step.

3 – Put the shutter on, and confirm the shutter is on by touching / clicking on .



4 – Checking

The unit checks that the flow rate and P1 and P2 pressures fall below the predefined thresholds: flow rate lower the 5 liters / minute and P1 and P2 pressures lower than 250 mbar. As soon as these thresholds are reached, the pump stops and the test goes on to the next step.

5 – Put the shutter off and confirm the shutter is off by touching / clicking on .




6 – Finalization and report edition


The « Begin » column gives the flow rate and pressure values before the shutter is placed, the « End » column, the values when the shutter is in place.

The test is successful when the conditions of flow rate lower than 5 liters / minute and pressures P1 and P2 lower than 250 mbar are respected.

When the test fails, this status is displayed in red in the report.


 stops the test at any time.

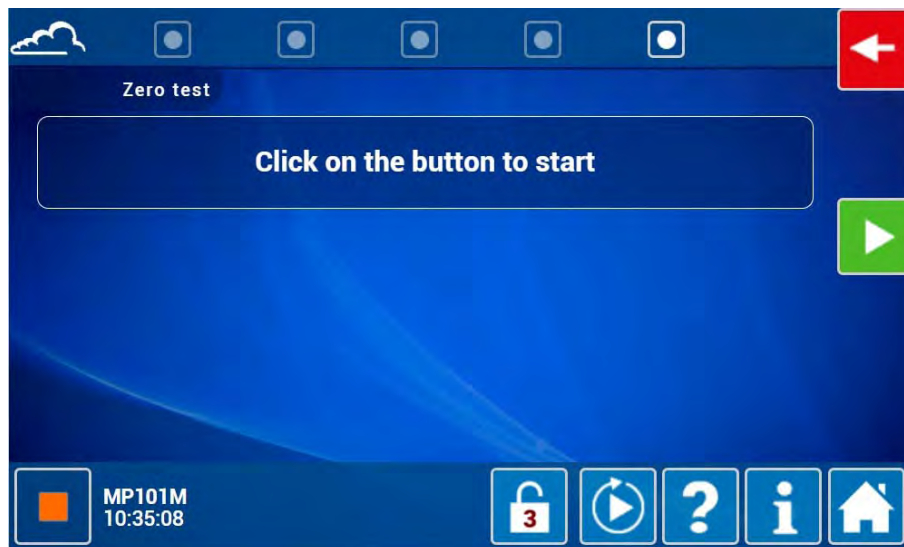
## Page 5: Zero test

The user accesses this page by touching / clicking on the fifth button  of the navigation bar at the screen top.

This test consists in performing a measurement with a zero particle filter placed on the sample input. Therefore, a zero particle filter must be installed on the sample inlet of the unit before carrying out this test.


This test is performed when the device is in the measurement cycle and can be run over many cycles and periods.

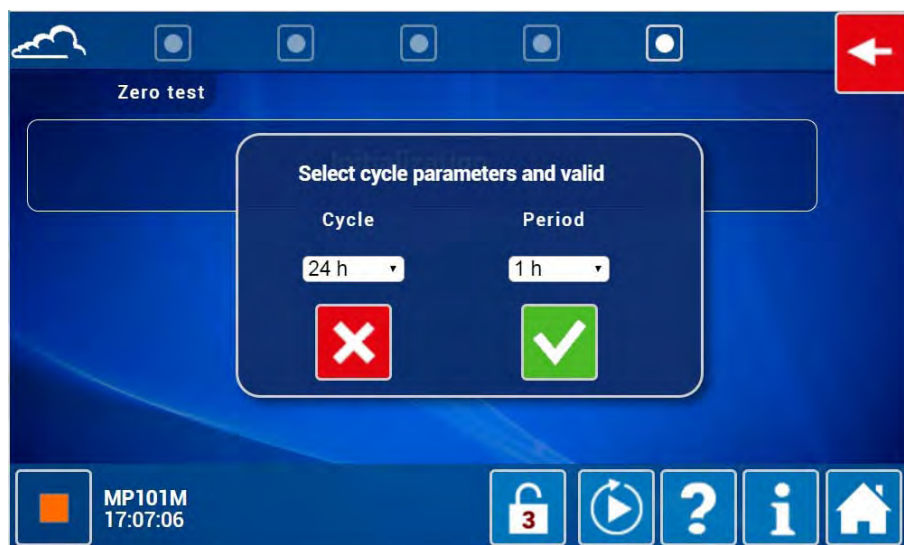
The user must first configure the test before launching it. For this, the user must start the test by touching / clicking on the button  and follow the sequence of the different steps reading the message displayed on the screen.




These steps are the following:

1 – Select the cycle parameters and validate

The user configure the cycle duration (possible choices: 30 minutes to 96h), and the period duration (possible choices: OFF, 10 min to 12h), then he validates the choice with .



## 2 – Enter the measurement parameters and validate

The user inputs the number of periods or cycles, i.e. 24 periods in the example above. As the period duration were fixed to 1h during the previous step, the zero test will therefore last 24h (i.e. 24 periods of 1h). If the user chooses a duration of 24 cycles, the zero test will therefore last 24 days (24 cycles of 24 hours). The user also has the possibility to exclude the first measures which, consequently, will not be taken into account in the report. Then he validates his choice with .



**NOTE :** Pay attention to configure a sufficient cycle duration if the zero test is performed on periodic measurements.


Example 1: cycle duration = 24h, period duration = 2h, zero test duration = 24 periods

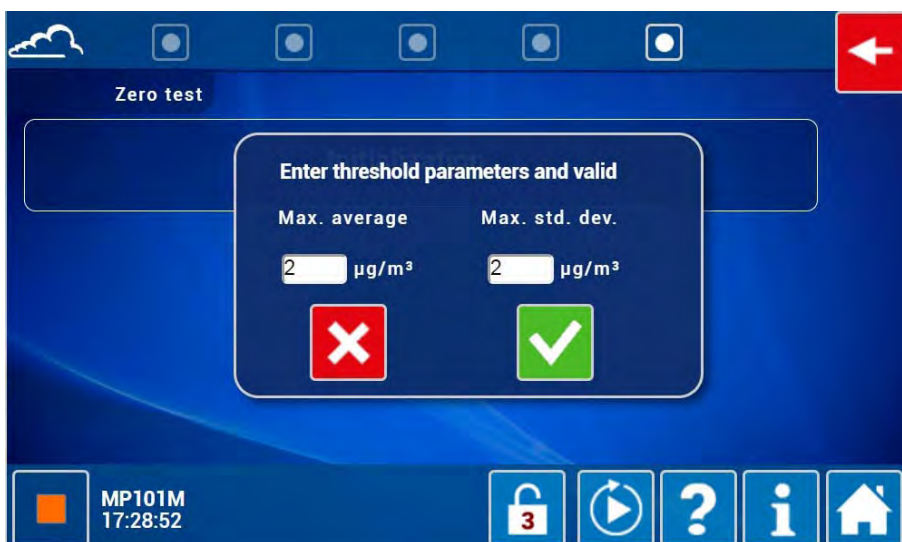
⇒ a cycle change will occur after 12 periods. A new blank will be therefore performed at half test.

Example 2: cycle duration = 48h, period duration = 2h, zero test duration = 24 periods



⇒ no cycle changes will occur.

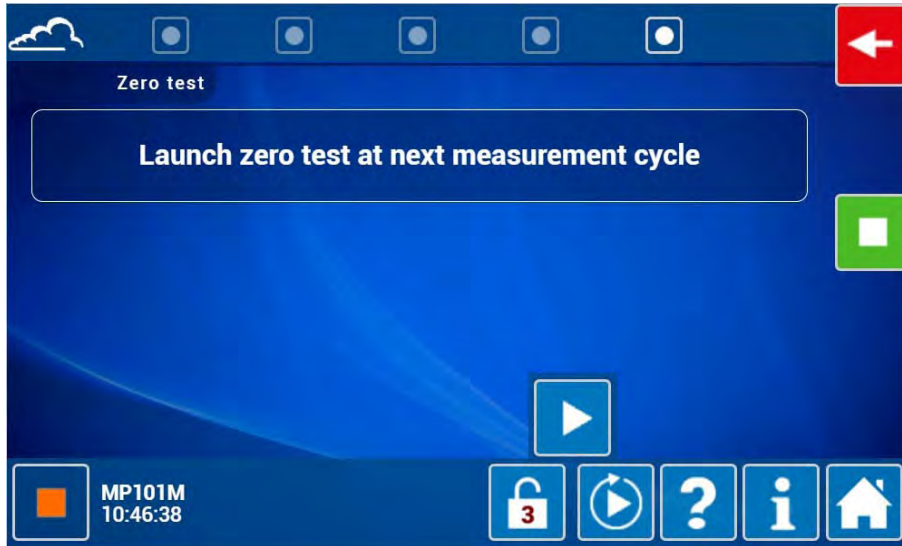
## 3 – Enter threshold parameters and valid

The user defines here the test validation criteria: at the test end, the measurement average fixed in the previous screen and the standard deviation must be lower than the « Max. average » and « Max. std. dev. » threshold values fixed here. Then he validates his entry with .



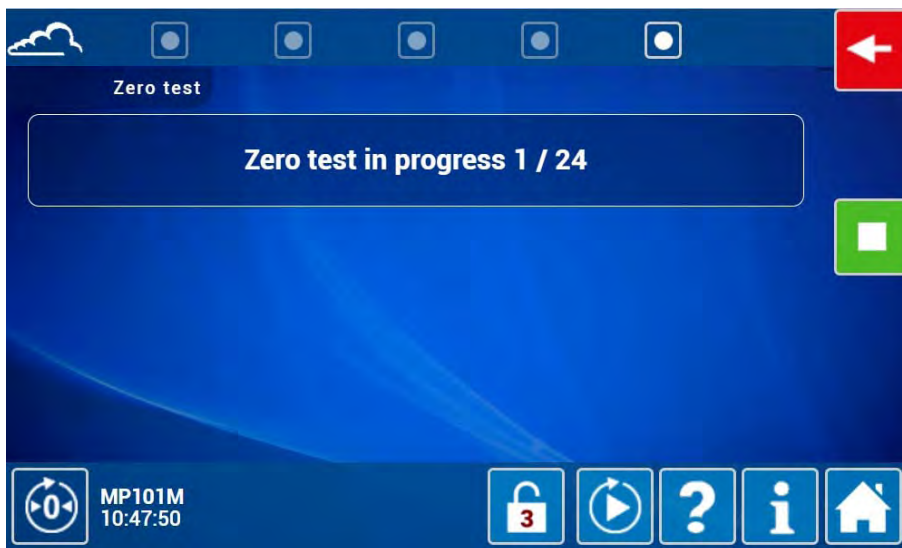
4 – Launch zero test at next measurement cycle



The user must configure the start type in the « *Advanced analyzer configuration* » screen, then he starts the measurement by touching / clicking on  then on .



5 – Zero test is in progress


The user follows-up the test progress in this screen.



 replaces  in the bottom browsing bar present in all screens, informing the user that a zero test is in progress.



### 3.4.2.13. Gauge calibration

The user accesses this screen by touching / double-clicking on .

This test consists in successively performing blank measurements and span measurements, then calculating their average and standard deviation.

When the analyzer is in measurement, the screen indicates the « *Measurement cycle in progress* » message and displays:

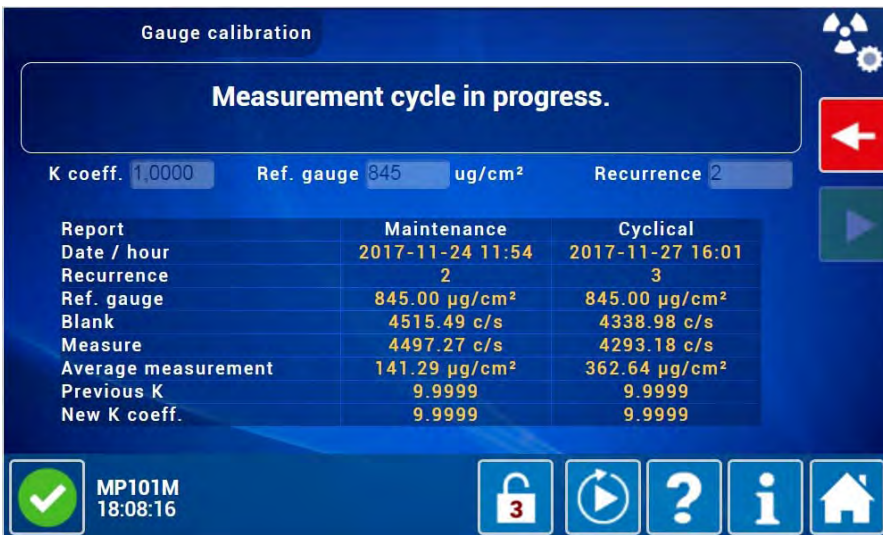
- the Beta calibration coefficient K determined during the previous calibration,
- the value of the reference gauge used for the calibration,
- the recurrence, i.e. the number of times the unit performs the blank measurement and the span measurement. It is involved in the average measurement calculation of the test report and is fixed to 10 by default. The recurrence is configurable and must be checked before starting the test.
- the report of the last calibrations carried out during a maintenance or a (cyclic) measurement:
  - A « maintenance » gauge calibration can be carried out with the automatic or manual reference gauge. In the first case, the reference gauge will be inserted automatically at the blank measurement end. In the second case, the user will have to manually insert the reference gauge.
  - A « cyclic » gauge calibration is performed at regular intervals during measurement, and with the automatic reference gauge. The cyclic gauge calibration is configured in the « Automatic calibration » column of the « *Automatic function configuration* » screen.

**NOTE :** The configuration advised is :

⇒ Recurrence = 3,

⇒ Frequency > 30.

(The unit performs a gauge calibration and modifies its calibration coefficient once a month at max).





**Gauge calibration**


**Measurement cycle in progress.**


K coeff. 1.0000    Ref. gauge 845 ug/cm<sup>2</sup>    Recurrence 2

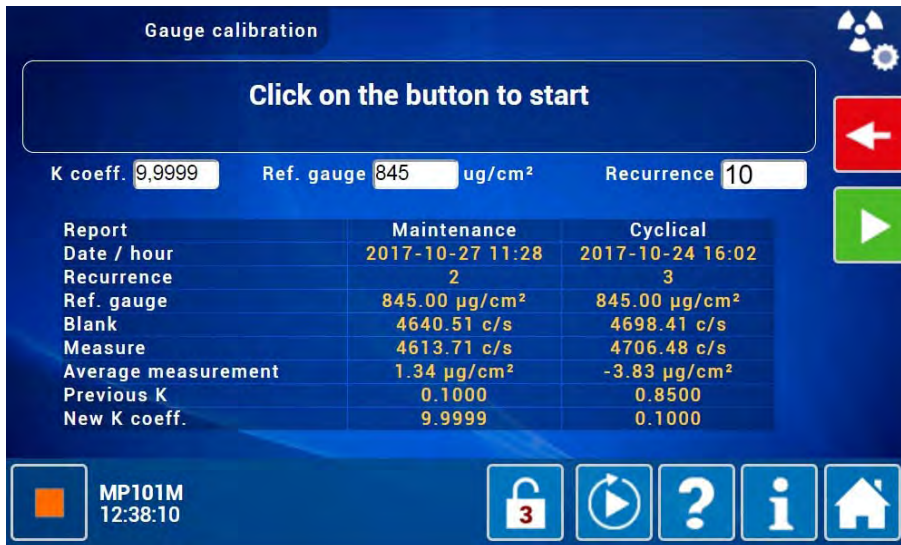
Report	Maintenance	Cyclical
Date / hour	2017-11-24 11:54	2017-11-27 16:01
Recurrence	2	3
Ref. gauge	845.00 µg/cm <sup>2</sup>	845.00 µg/cm <sup>2</sup>
Blank	4515.49 c/s	4338.98 c/s
Measure	4497.27 c/s	4293.18 c/s
Average measurement	141.29 µg/cm <sup>2</sup>	362.64 µg/cm <sup>2</sup>
Previous K	9.9999	9.9999
New K coeff.	9.9999	9.9999

MP101M 18:08:16

To perform a gauge calibration, it is necessary to stop the measurement cycle in progress by touching / clicking on  and then on  and to wait for the start screen display, as shown below.

Start the gauge calibration by touching / clicking on the button . The user follows-up the sequence of the various steps reading the message displayed on the screen.

 stops the test at any time.



**Gauge calibration**

Click on the button to start

K coeff. 9.9999    Ref. gauge 845 ug/cm<sup>2</sup>    Recurrence 10

Report	Maintenance	Cyclical
Date / hour	2017-10-27 11:28	2017-10-24 16:02
Recurrence	2	3
Ref. gauge	845.00 µg/cm <sup>2</sup>	845.00 µg/cm <sup>2</sup>
Blank	4640.51 c/s	4698.41 c/s
Measure	4613.71 c/s	4706.48 c/s
Average measurement	1.34 µg/cm <sup>2</sup>	-3.83 µg/cm <sup>2</sup>
Previous K	0.1000	0.8500
New K coeff.	9.9999	0.1000

MP101M 12:38:10

These steps are the following:

- 1 – Initialization
- 2 – Drying paper
- 3 – Geiger warm-up
- 4 – Blank 1/10.
- 5 – Geiger rest
- 6 – Geiger warm-up
- 7 – Blank 2/10



**Gauge calibration** 42 s

**Blank 2 / 10**    4837 c/s

Previous Blank 4830 c/s


K coeff. 9.9999    Ref. gauge 845 ug/cm<sup>2</sup>    Recurrence 10

Report	Maintenance	Cyclical
Date / hour	2017-10-27 11:28	2017-10-24 16:02
Recurrence	2	3
Ref. gauge	845.00 µg/cm <sup>2</sup>	845.00 µg/cm <sup>2</sup>
Blank	4640.51 c/s	4698.41 c/s
Measure	4613.71 c/s	4706.48 c/s
Average measurement	1.34 µg/cm <sup>2</sup>	-3.83 µg/cm <sup>2</sup>
Previous K	0.1000	0.8500
New K coeff.	9.9999	0.1000

MP101M 12:43:34

The blank measurement continues until reaching Blank 10/10, repeating the two successive « Geiger rest » and « Geiger warm-up » steps between each new blank measurement. The last blank value is refreshed at each new blank measurement.

8 – Insert reference gauge.

When the calibration is manual, the user must confirm the presence of reference gauge by touching / clicking on .

9 – Reference gauge checking.

10 – Reference gauge inserted.

11– Geiger warm-up

12 – Measure 1/10


13 – Geiger rest

14 – Geiger warm-up

15 – Measure 2/10

16 – Geiger rest

17 – Geiger warm-up



Gauge calibration 53 s

**Measure 2 / 10** **4780 c/s**

Previous Blank 4830 c/s Previous Measure 4826 c/s


K coeff. 9.9999 Ref. gauge 845 ug/cm<sup>2</sup> Recurrence 10

Report	Maintenance	Cyclical
Date / hour	2017-10-27 11:28	2017-10-24 16:02
Recurrence	2	3
Ref. gauge	845.00 ug/cm <sup>2</sup>	845.00 ug/cm <sup>2</sup>
Blank	4640.51 c/s	4698.41 c/s
Measure	4613.71 c/s	4706.48 c/s
Average measurement	1.34 ug/cm <sup>2</sup>	-3.83 ug/cm <sup>2</sup>
Previous K	0.1000	0.8500
New K coeff.	9.9999	0.1000

MP101M 12:46:41

The span measurement continues until reaching Measure 10/10, repeating the two successive « Geiger rest » and « Geiger warm-up » steps between each new span measurement.

The screen displays the last blank value and the last span measurement performed. This value is refreshed at each new measurement.


When the measure 10/10 is finished, the screen indicates « Geiger rest », then « Pull out reference gauge ». When the gauge calibration is manual, the user must confirm the pull out reference gauge by touching / clicking on  to go to the last two steps:

n-1 – Reference gauge checking

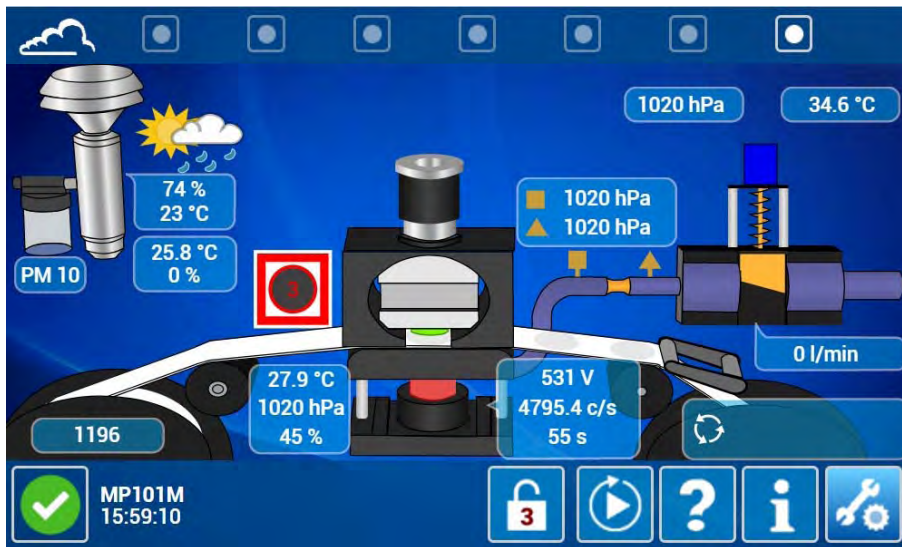
n – Finalization.

The screen is refreshed with the new test report edition.


### **Follow-up of the cyclic beta gauge calibration**


During the cyclic beta gauge calibration, a red icon  is displayed in the Synoptic screen allowing the user to follow the countdown (3 - 2 - 1) of the recurrence defined in the « *Automatic function configuration* » screen. At the cyclic calibration end, the test report is edited in the cyclic column window of the gauge calibration.

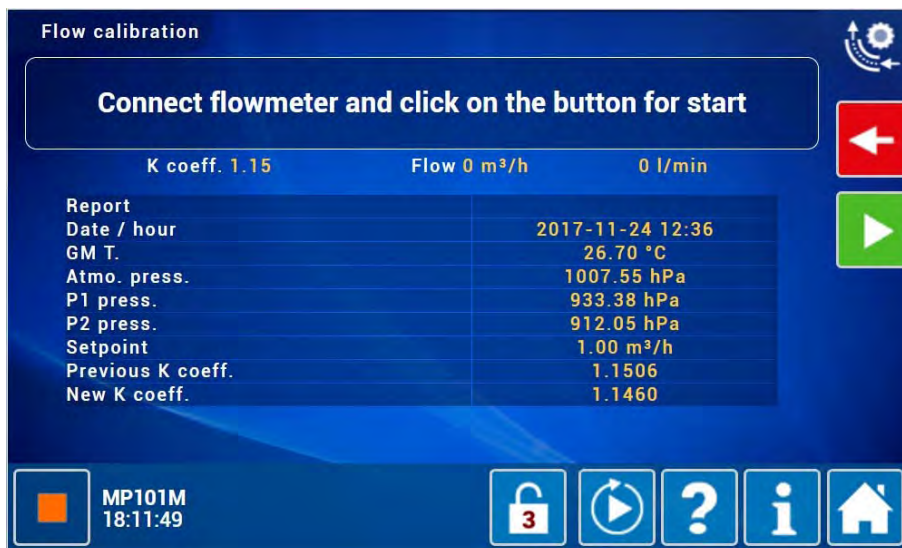




### 3.4.2.14. Flow calibration


The user accesses this screen by touching / double-clicking on .

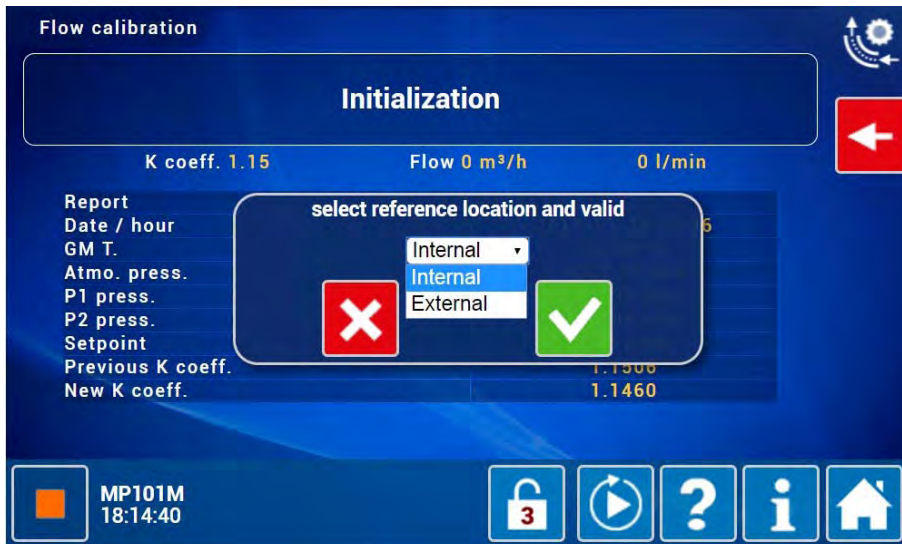
The user performs flow calibration by following the instructions on the screen. First, he connects a flowmeter to the analyzer and then touches / clicks on  to start the flow calibration procedure.





The flowmeter can be placed Internal or External. The user must select the Internal or External location of the flowmeter:




- For a calibration performed in laboratory, he selects **Internal** and connects the flowmeter directly on the MP101M sample inlet.
- For a calibration performed on site, he selects **External** and connects the flowmeter on the RST line installed External.

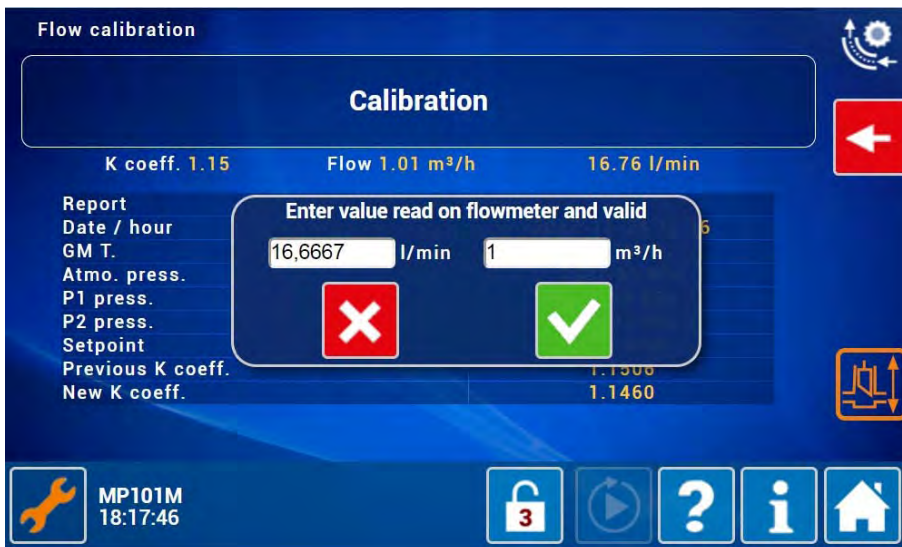
Then, the user validates the choice by touching / clicking on .





In the next window, he enters a setpoint value equal to 1 m<sup>3</sup>/h, and validates by touching / clicking on 

The « Initialization » then « Calibration » message are displayed on the screen. The user must then enter the value read on the flow meter and valid its entry by touching / clicking on .

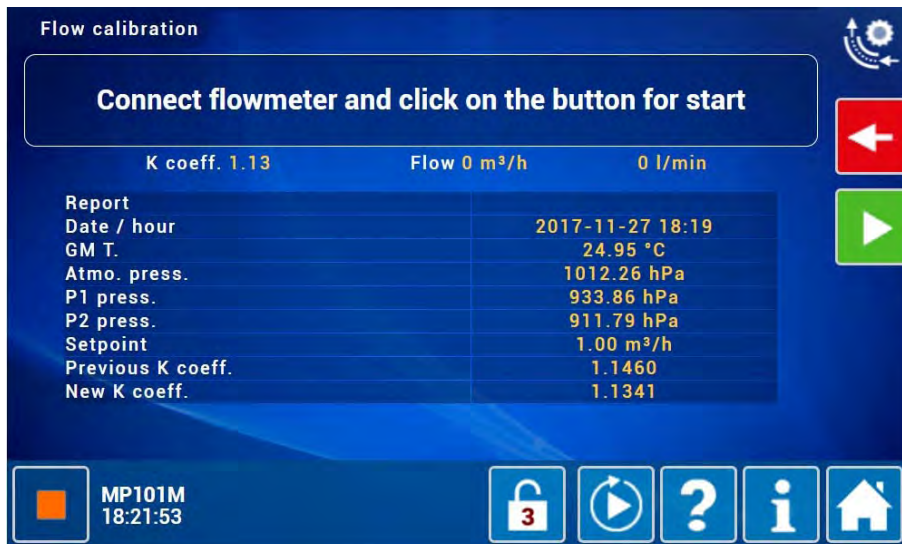
In this screen, the user can manually control the flow rate regulation valve by touching / clicking on  which becomes  and displays the adjustment controls: .



In the last step, the unit asks the user to finalize the flow rate calibration: if he is satisfied with the flow rate value obtained, he finalizes by touching / clicking on . Otherwise, he touches / clicks on  to return to the previous screen and enter again the value read on the flow meter.




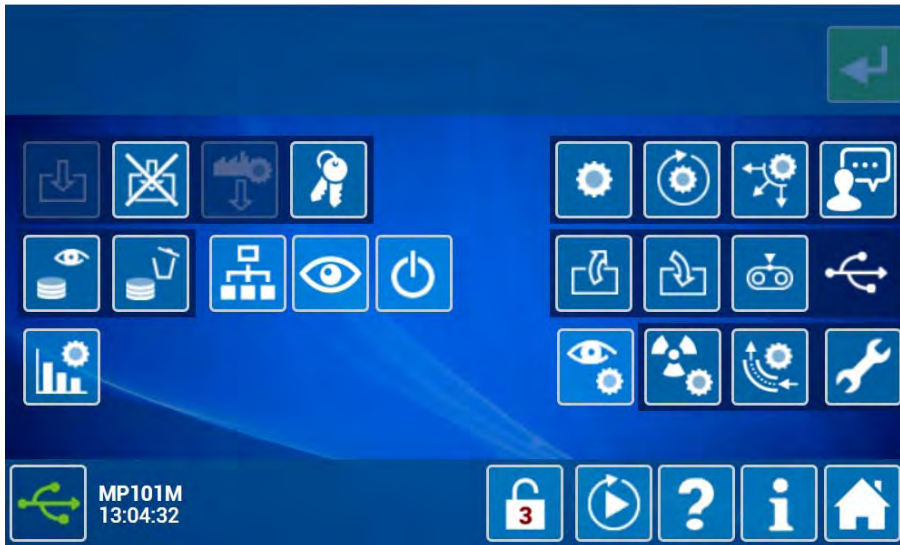
The test ends with the test report refreshment.








### 3.4.2.15. USB function activation

The USB function is activated automatically by inserting a USB key on the unit: the USB buttons light up on the advanced function home page and the icon  displayed in the bottom browsing bar indicates that a USB key is connected the unit.




**USB memory:** by touching / clicking on  the user displays  indicating the total and free memory of the key.


**Record instantaneous measurement on USB key:** by touching / clicking on , the user opens the window for configuring the recording functions on the key. The data to be recorded are the following:


MEAS. CHANNEL: these are all measurement channels configures in the « *General configuration (Address, Protocol, Measurement channels...)* » screen.

SENSOR : These are all the sensors indicated in the SENSORS section of the « *Diagnostic functions (alarm, input / output, mux...)* » screen, page 2: temperature, pressure, flow rate, hygrometry.

VOLTAGE : these are all the voltage indicated in the POWER SUPPLIES section of the « *Diagnostic functions (alarm, input / output, mux...)* » screen, page 2: GND, + 15V, HV Geiger, Ref. RH.

The user touches / clicks on the items for selection, fills in the archiving PERIOD(S) and recording DURATION (DD:HH:MM), then launches the recording on the USB key with .

 stops the recording.



 closes the window.






The files are recorded in the « envsa » folder of the USB key, which includes the following subfolders:

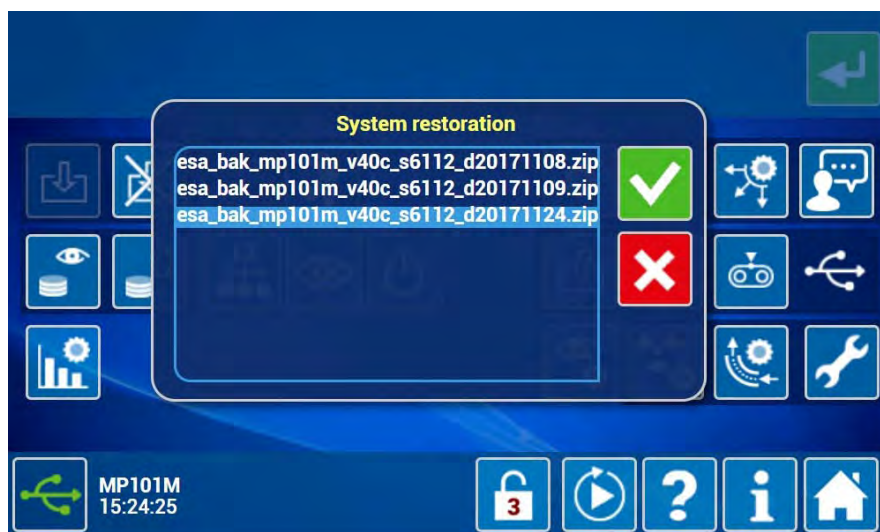
- dataalim for recorded data files related to voltages,
- datacalcul for recorded data files related to calculations.
- datainst for recorded data files related to measure channels,
- datamux for recorded data files related to sensors.

#### **Configuration and software backup on USB key:**

The user launches the backup on the USB key by touching / clicking on : a window opens on the screen indicating the « System backup – Operation in progress, please wait » message. At backup end, the « System backup – Operation completed successfully » message is displayed. The user can then close the window with .


#### **Update or restore software and configuration from USB key (System will restart on operation completion):**

By touching / clicking on  the user opens the system restoration window, in which he touches / clicks on the file to be selected. Then, he touches / clicks on  to download the file in the device, or on  to close the window.




When downloading, the icon  becomes  meaning that the USB key is busy and it should not be removed.




When the operation is finished, the user closes the window with .

#### 3.4.2.16. Optional interface configuration



The user accesses this screen by touching / double clicking on .

This screen allows testing and configuration of the analyzer's available i2C boards.

NOTE: This screen is optional.  is activated in the advanced function home page when an i2C board interface is connected to the analyzer.



##### **Analog and digital inputs and outputs monitoring screen:**

DIG. OUTPUT column (1): monitors the digital outputs (relays). It is used to activate → de-activate them by touching the associated buttons:

-  (yellow): relay is activated (normally closed)
-  (green): relay is de-activated (normally open).


ANALOG OUTPUT column (2): monitors the analog outputs. Output voltage modification is performed by touching and moving the cursor: it allows calibrating outputs, voltages or the current mode.

DIG. INPUT column (3): monitors digital inputs.


-  (yellow): remote control is activated
-  (green): remote control is de-activated.

ANALOG INPUT column (4): monitors analog inputs. It shows the analog input voltage values. Scale is 0–2500 mV.



The user accesses also this analog and digital input and output monitoring screen by touching / double clicking on .

### Analog and digital outputs configuration screen

The user accesses this screen by touching / double clicking on .

DIGITAL OUTPUT column (1): for each digital output, a field allows channel selection to be assigned to the associated output; a switch allows selection of output type: N.O. (normally open) or N.C. (normally closed).


ANALOG OUTPUT column (2): allows setting the Ax+B linearization curve for the four analog outputs. For each output:

- a field allows selection of the measurement source (for example NO2, as shown in field 3) and fields A and B allow fixing the coefficient for conversion from the measured value to the point number.
- there are four possible ranges: they allow setting the dynamics of the output signal associated with the measurement.





### Analog and digital input configuration screen

The user accesses this screen by touching / double clicking on .

ANALOG INPUTS column (1): allows linearization curve for the four analog inputs.

For each analog input:

- one field allows naming the analog input,
- one field allows unit input associated with the analog input,
- two fields allow setting coefficients A and B for the conversion ( $y = Ax + B$ ).

DIGITAL INPUTS column (2): Displays the assignment of the four digital remote control inputs.

For each digital input, the available assignment choices are: « *Disable* », « *Sample* », « *Zero* », « *Span* », « *Zero cycle* », « *Span cycle* », « *Ref. Zero* », « *Auto Calibration* », and « *Standby* ».



## CHAPTER 4 PREVENTIVE MAINTENANCE

4.1.	SAFETY INSTRUCTIONS	4-2
4.2.	MAINTENANCE CALENDAR	4-3
4.3.	MAINTENANCE OPERATION SHEETS	4-3
4.4.	EQUIPMENT NECESSARY FOR MAINTENANCE	4-40
4.5.	SPARE PART LIST WITH PICTURES	4-42
Figure 4-1 – Diagram of the Picolino pump		4-5
Figure 4-2 – KNF pump diagram		4-6
Figure 4-3 – Cleaning of PM10 EN12341 and PM2.5 EN14907 sampling heads		4-9
Figure 4-4 – Cleaning of US-EPA standardized PM10 inlet		4-10
Figure 4-5 – Cleaning of US-EPA standardized VSCC™		4-11

## 4. PREVENTIVE MAINTENANCE

### 4.1. SAFETY INSTRUCTIONS

The user must follow all the safety instructions at all times:

- Always turn off the power supply when performing analyzer maintenance.
- Take the necessary precautions when handling dangerous products (example: gloves, protective mask, etc.).
- Personnel should be trained in the proper operation of this equipment before attempting to operate it.
- The manufacturer shall not be responsible for any adverse outcomes resulting from the following:
  - Use of the monitor by unqualified service personnel.
  - Use of the monitor under conditions other than those specified in this document.
  - Use of components or accessories not manufactured by ENVEA. Failure to use recommended parts may reduce the safety features.
  - Use of this equipment in a manner not approved by ENVEA as it can cause harm to the equipment or operating personnel. Inappropriate maintenance of the analyzer.
- A periodic inspection is required.

#### REMINDER

**Refer to Chapter 0, safety guidelines section, pages 0-10 to 0-18.**



## 4.2. MAINTENANCE CALENDAR

By its design, the MP101M requires very limited maintenance. However, the unit must be regularly serviced to ensure proper performance over time. The routine maintenance schedule shown below is an example, and this schedule can vary according to operating conditions.

Nature of operations	Periodicity	Sheet N°
– Check of Picolino pump assembly	1 year	4.3.1
– Check of KNF pump assembly	1 year	4.3.2
– Sampling head cleaning	1 month	4.3.3
– Supply checking	3 months	4.3.4
– Filter ribbon replacement	1 to 3 years	4.3.5
– Checking of the pressure exerted on the filter	1 year	4.3.6
– Checking of temperature, pressure and humidity sensors	3 months	4.3.7
– Flow checking	3 months	4.3.8
– Calibration of temperature, pressure and humidity sensors	1 year	4.3.9
– Aspiration flow calibration	1 year	4.3.10
– Leak test	1 year	4.3.11
– Gauge calibration	1 year	4.3.12
– Automatic contamination test	3 months	4.3.13
– Beta gauge checking (gauge test, mass test)	1 year	4.3.14
– Checking of zero point measurement	1 year	4.3.15
– Geiger Muller (GM) tube replacement	If fault detected	4.3.16

## 4.3. MAINTENANCE OPERATION SHEETS

As indicated in the previous page:

<b>WARNINGS</b>
– Refer to chapter 0, safety guidelines section, pages 0-10 to 0-18.

## MAINTENANCE SHEET

<b>Monitor serial No.:</b>	<b>OPERATION SHEET : 4.3.1</b>	
<b>Scope : Check of Picolino pump assembly (impeller pump)</b>	<b>PAGE : 1/2</b>	<b>Periodicity : 1 year</b>
<p><u>Replacement parts</u> : Maintenance kit of PICOLINO VTE3 pump assembly ref. SAV-K-000145</p> <p><u>Procedure</u> :</p> <p>1/ Before any intervention, stop the measurement cycle and disconnect the pump from the analyzer.</p> <p>2/ Remove the body cover (4).</p> <p>3/ Remove the filtering cartridge (5) as well as an impeller (3) to check their wearing status.</p> <p>4/ The filtering cartridges (5) must be cleaned according to the dust amount :</p> <ul style="list-style-type: none"> <li>- Purge the filter with compressed air from inside towards outside (do not wash it).</li> <li>- Replace the clogged or oily cartridges by new ones.</li> </ul> <p>5/ Impellers wear away (3) because of friction against the wall of the pump body :</p> <ul style="list-style-type: none"> <li>- Check the impeller size.</li> <li>- During replacement, purge the pump body with compressed dry air.</li> </ul> <p>6/ If necessary, replace the seals contained in the maintenance kit. See (6) (7) (34) of Figure 4-1.</p> <p>7/ Replace the body cover.</p>		<b>Dates</b>
<ul style="list-style-type: none"> <li>- <b>Tools required</b> <ul style="list-style-type: none"> <li>• Maintenance kit of PICOLINO VTE3 pump ref.: SAV-K-000145</li> </ul> </li> </ul>		

## MAINTENANCE SHEET

<b>Monitor serial No.:</b>	<b>OPERATION SHEET : 4.3.1</b>	
<b>Scope : Check of Picolino pump assembly (impeller pump)</b>	<b>PAGE : 2/2</b>	<b>Periodicity : 1 year</b>

Replacement parts : Maintenance kit of PICOLINO VTE3 pump assembly ref. SAV-K-000145

	Basic parts	Éléments de base
1	Housing	Corps
2	Rotor	Rotor
3	Blade	Palette
4	Housing cover	Couvercle de corps
5	Filter cartridge	Cartouche du filtre
6	Sealing ring	Anneau d'étanchéité
7	Sealing disc	Disque d'étanchéité
8	Disc	Rondelle
9	Spring shim	Rondelle ressort
10	Hexagon head screw	Vis six pans
11	Spacer shim	Rondelle entre-toise
20	Motor with connection cover	Moteur avec couvercle raccordement
50	Screw	Vis
51	Screw	Vis
Assembly parts		Éléments de montage
30	Hose connection	Raccord tuyau
38	Lock plug	Bouche obturateur
34	Sealing ring	Anneau d'étanchéité
36	Exhaust silencer	Silencieux refroidement
Optional extras		Accessoires
38	Vacuum regulating valve	Valve réglage vide
Labels		Plaques signalétiques
40	Data plate	Étiquette caractéristique
41	Motor name plate	Étiquette caractérist. moteur
42	Company label with serial-no.	Étiquette compagnie avec numéro de série

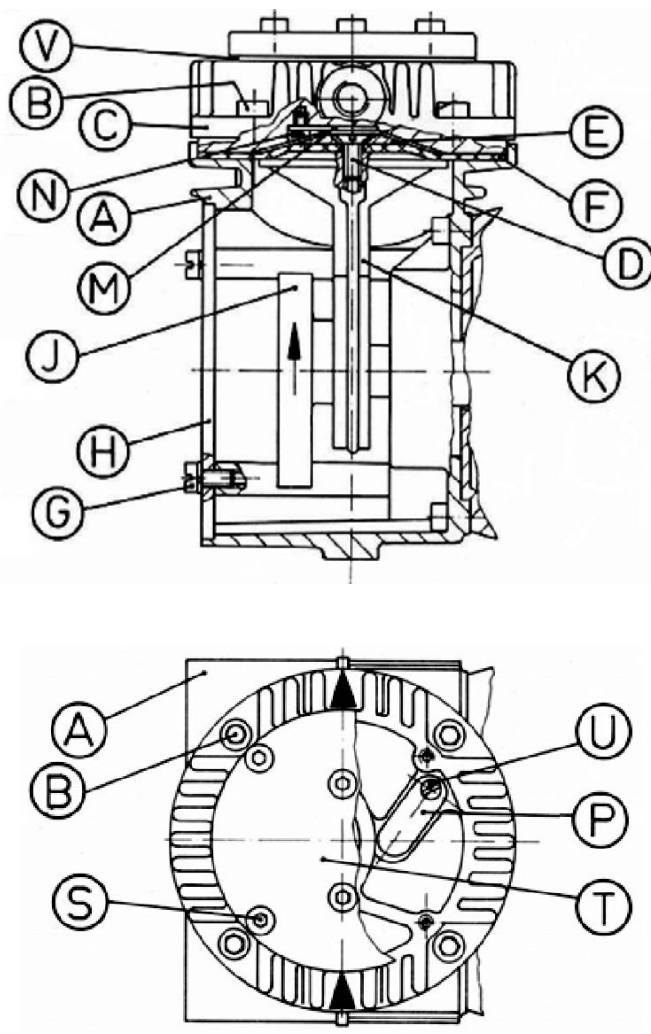
V = Wearing parts    D = Seals  
 V = Pièces d'usure    D = Joints

Figure 4-1 – Diagram of the Picolino pump

– **Tools required**

- Maintenance kit of PICOLINO VTE3 pump ref. :SAV-K-000145

MAINTENANCE SHEET

<p>Monitor serial No.:</p>	<p>OPERATION SHEET : 4.3.2</p>		
<p>Scope : Check of KNF pump assembly</p>	<p>PAGE : 1/2</p>	<p>Periodicity : 1 year</p>	
<p><u>Replacement parts</u> : Maintenance kit of KNF pump, ref. V02-K-0012</p> <div style="text-align: center;">  </div> <p>(A) pump body, (B) hexagon socket head screw, (C) cylinder head, (D) diaphragm screw, (E) tightening disc, (F) diaphragm, (G) screw of body pump cover, (H) pump body cover, (J) counterweight, (K) connecting rod, (L) lock washer, (M) lower check valve, (N) check valve screw, (P) upper check valve, (S) head screw, (T) head cover, (U) check valve screw, (V) seal.</p> <p style="text-align: center;"><b>Figure 4-2 – KNF pump diagram</b></p>		<p>Dates</p>	
<p>– <b>Tools required</b></p> <ul style="list-style-type: none"> <li>• Maintenance kit KNF pump ref. V02-K-0012</li> </ul>			



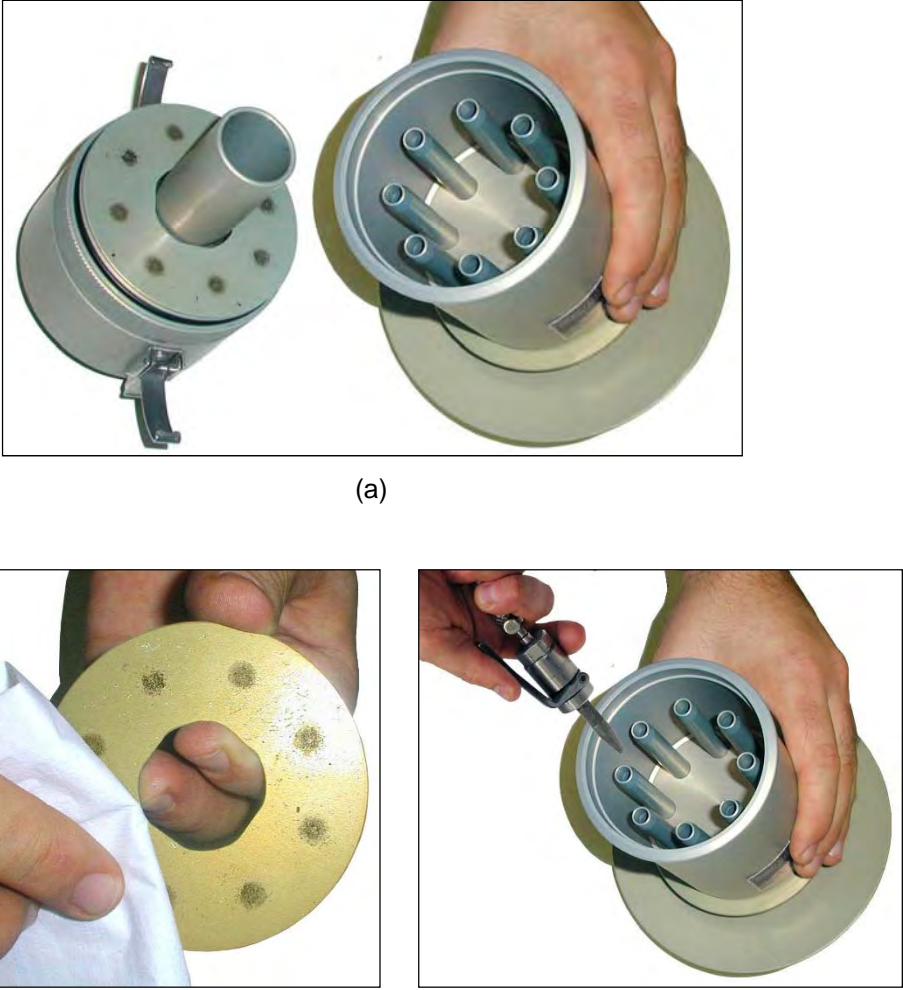
## MAINTENANCE SHEET

<b>Monitor serial No.:</b>	<b>OPERATION SHEET : 4.3.2</b>	
<b>Scope : Check of KNF pump assembly</b>	<b>PAGE : 2/2</b>	<b>Periodicity : 1 year</b>
<p><u>Replacement parts</u> : Maintenance kit of KNF pump, ref. V02-K-0012</p> <p><u>Procedure</u> :</p> <p>1/ Stop the measurement cycle and disconnect the pump from the analyzer before any intervention.</p> <p>2/ Disassembly of a pump head :</p> <ul style="list-style-type: none"> <li>– Mark with a pen line the cover (T), the cylinder head (C) and the pump body (A) to avoid an incorrect positioning of parts during reassembly.</li> <li>– Unscrew the four hexagon socket head screws (B) of fixation and remove the assembly composed of the cover (T) and the cylinder head (C) of the pump body.</li> </ul> <p>3/ Replacement of the diaphragm :</p> <ul style="list-style-type: none"> <li>– Unscrew the screw (D) and remove the tightening disc (E), the lock washer (L) as well as the diaphragm (F).</li> <li>– Remove the four screws (G) and remove the cover (H) to access the mechanical part of the pump body.</li> <li>– Place the connecting rod (K) in half-stroke position turning the counterweight, then put in place the new diaphragm (F).</li> <li>– Check the cleanliness of the whole parts, and, if necessary, clean them.</li> <li>– Replace the disc (E) and the lock washer (L) on the diaphragm and strongly tighten the whole using the screw (D).</li> <li>– Replace the cover (T) and cylinder head (C) assembly by respecting the position of pen line. Settle regularly and crosswise, using the hexagon socket head screw.</li> <li>– Check operation by manually turning the counterweight. There should not be stiff point. Put in place the cover (H) with the screws (G).</li> </ul> <p>4/ Replacement of check valves and O-rings :</p> <ul style="list-style-type: none"> <li>– Remove the cover (T) from the cylinder head by unscrewing the six screws (S).</li> <li>– Remove the screw of the check valve (N), remove and replace the worn lower check valve of the cylinder head.</li> <li>– Check cleanliness of the cylinder head, cover and housings of check valves. In case of unevenness, scratches or corrosion, parts replacement is necessary.</li> <li>– Remove the screw of the check valve (U), remove and replace the worn upper check valve (P).</li> </ul> <p>5/ Putting back in place the pump head: replace the cover (T) with a new gasket (V) and tighten the six screws (S) regularly and crosswise.</p> <p>6/ Do the same with the second pump head.</p> <p>7/ Put back in place the pneumatic connections between the two pump heads.</p> <p>8/ Re-connect the pump to the analyzer.</p>		<b>Dates</b>
<ul style="list-style-type: none"> <li>– <b>Tools required</b> <ul style="list-style-type: none"> <li>• Maintenance kit of KNF pump ref. V02-K-0012</li> </ul> </li> </ul>		




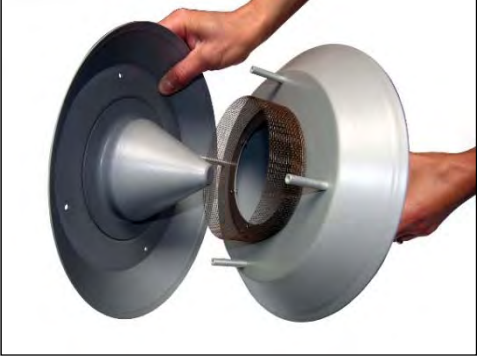

## MAINTENANCE SHEET

<b>Monitor serial No.:</b>	<b>OPERATION SHEET : 4.3.3</b>	
<b>Scope : Sampling head cleaning</b>	<b>PAGE : 1/4</b>	<b>Periodicity : 1 month</b>
<p><u>European standardized sampling heads : (Figure 4–3)</u></p> <ul style="list-style-type: none"> <li>– Loosen the settling ring and separate the head from the sampling tube by simple vertical pulling.</li> <li>– Remove the cover and the protection grid.</li> <li>– Brush the grid in order to remove any foreign body.</li> <li>– Remove the body from the head (a).</li> <li>– Clean the impact plate (with alcohol if necessary to remove fat) (b).</li> <li>– Pass a swab into the sampling channel.</li> <li>– Clean the eight orifices with compressed air (c).</li> <li>– Coat the impaction plate with silicon grease for vacuum.</li> </ul> <p><u>US-EPA standardized sampling head: (Figure 4–4)</u></p> <ul style="list-style-type: none"> <li>– Separate the head from the sampling tube by simple vertical pulling.</li> <li>– Empty and clean the decantation bottle.</li> <li>– Brush the inlet grid.</li> <li>– Disassemble the head (a).</li> <li>– Pass a swab into the aspiration channel.</li> <li>– Clean the three orifices with compressed air (b).</li> <li>– Remove the four screws from the upper part covering the head (c).</li> <li>– Remove the parts (d).</li> <li>– Clean the inside and outside of the dirty parts with a soft cloth moistened with alcohol (e).</li> <li>– Dry the parts.</li> <li>– When cleaning is finished, reassemble the US-EPA standardized sampling head.</li> </ul> <p><u>US-EPA standardized VSCC™: (Figure 4–5)</u></p> <ul style="list-style-type: none"> <li>– Disassemble the various parts of the VSCC™ as shown in (a). No tool is required.</li> <li>– Clean the inside and outside (b) of the dirty parts with a soft cloth moistened with alcohol.</li> <li>– Dry the parts and check the O-rings (change them if necessary).</li> <li>– Reassemble VSCC™, as shown in (c).</li> </ul>		<b>Dates</b>
<ul style="list-style-type: none"> <li>– <b>Tools required</b> <ul style="list-style-type: none"> <li>• Cylinder of compressed air,</li> <li>• Nylon brush, soft cloth.</li> <li>• Silicon grease for vacuum</li> <li>• Alcohol</li> </ul> </li> </ul>		


## MAINTENANCE SHEET

<b>Monitor serial No.:</b>	<b>OPERATION SHEET : 4.3.3</b>	
<b>Scope : Sampling head cleaning</b>	<b>PAGE : 2/4</b>	<b>Periodicity : 1 month</b>
<div style="text-align: center;">  <p>(a)</p> <p>(b)</p> <p>(c)</p> </div> <p style="text-align: center;"><b>Figure 4-3 – Cleaning of PM10 EN12341 and PM2.5 EN14907 sampling heads</b></p>		<p style="text-align: center;"><b>Dates</b></p>
<p>– <b>Tools required</b></p> <ul style="list-style-type: none"> <li>• Cylinder of compressed air,</li> <li>• Nylon brush, soft cloth.</li> <li>• Silicon grease for vacuum</li> <li>• Alcohol</li> </ul>		

MAINTENANCE SHEET

<p>Monitor serial No.:</p>	<p>OPERATION SHEET : 4.3.3</p>	
<p>Scope : Sampling head cleaning</p>	<p>PAGE : 3/4</p>	<p>Periodicity : 1 month</p>
<div style="display: flex; flex-wrap: wrap;"> <div style="width: 50%; text-align: center;">  <p>(a)</p> </div> <div style="width: 50%; text-align: center;">  <p>(b)</p> </div> <div style="width: 50%; text-align: center;">  <p>(c)</p> </div> <div style="width: 50%; text-align: center;">  <p>(d)</p> </div> <div style="width: 50%; text-align: center;">  <p>(e)</p> </div> </div> <p style="text-align: center;"><b>Figure 4-4 – Cleaning of US-EPA standardized PM10 inlet</b></p>		<p style="text-align: center;">Dates</p>
<p>– <b>Tools required</b></p> <ul style="list-style-type: none"> <li>• Cylinder of compressed air,</li> <li>• Nylon brush, soft cloth.</li> <li>• Silicon grease for vacuum</li> <li>• Alcohol</li> </ul>		

## MAINTENANCE SHEET

<b>Monitor serial No.:</b>	<b>OPERATION SHEET : 4.3.3</b>			
<b>Scope : Sampling head cleaning</b>	<b>PAGE : 4/4</b>	<b>Periodicity : 1 month</b>		
<div style="text-align: center;">  <p>(a)</p> <p>(b)</p> <p>(c)</p> </div> <p style="text-align: center;"><b>Figure 4-5 – Cleaning of US-EPA standardized VSCC™</b></p>		<table border="1" style="width: 100%; height: 100%;"> <thead> <tr> <th style="text-align: center;">Dates</th> </tr> </thead> <tbody> <tr> <td style="height: 150px;"> </td> </tr> </tbody> </table>	Dates	
Dates				
<p>– <b>Tools required</b></p> <ul style="list-style-type: none"> <li>• Cylinder of compressed air,</li> <li>• Nylon brush, soft cloth.</li> <li>• Silicon grease for vacuum</li> <li>• Alcohol</li> </ul>				





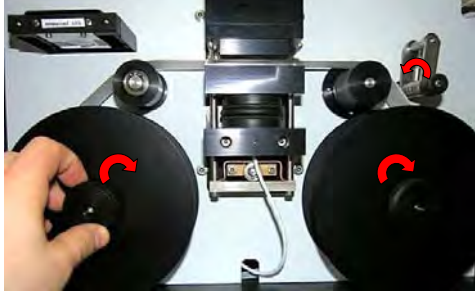
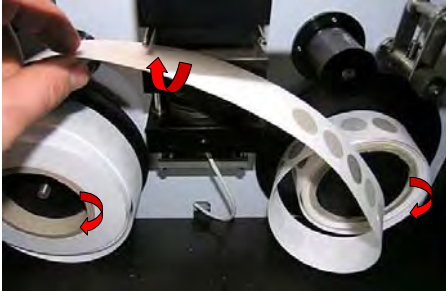

## MAINTENANCE SHEET

<b>Monitor serial No.:</b>		<b>OPERATION SHEET : 4.3.4</b>																												
<b>Scope : Supply checking</b>		<b>PAGE : 1/1</b>	<b>Periodicity : 3 months</b>																											
<p><u>Procedure :</u></p> <p>1/ Go to the second page of the « <i>Diagnostic functions (alarm, input / output, mux...)</i> » screen. Diagnostic functions</p> <p>2/ Check the supply values.</p> <table border="1"> <thead> <tr> <th>Supply°</th> <th>Reference value</th> <th>Tolerances</th> </tr> </thead> <tbody> <tr> <td>GND</td> <td>0 V</td> <td>± 50 mV</td> </tr> <tr> <td>+5V</td> <td>5000 mV</td> <td>± 200 mV</td> </tr> <tr> <td>+15V</td> <td>1500 mV</td> <td>± 50 mV</td> </tr> <tr> <td>-15V</td> <td>1500 mV</td> <td>± 50 mV</td> </tr> <tr> <td>Geiger HV</td> <td>550 V</td> <td>± 30 V</td> </tr> <tr> <td>Ref. 2.5V</td> <td>2500 mV</td> <td>± 50 mV</td> </tr> <tr> <td>Ref. RH</td> <td>3660 mV</td> <td>± 200 mV</td> </tr> <tr> <td>Ref. A/D</td> <td>2500 mV</td> <td>± 50 mV</td> </tr> </tbody> </table>			Supply°	Reference value	Tolerances	GND	0 V	± 50 mV	+5V	5000 mV	± 200 mV	+15V	1500 mV	± 50 mV	-15V	1500 mV	± 50 mV	Geiger HV	550 V	± 30 V	Ref. 2.5V	2500 mV	± 50 mV	Ref. RH	3660 mV	± 200 mV	Ref. A/D	2500 mV	± 50 mV	<b>Dates</b>
Supply°	Reference value	Tolerances																												
GND	0 V	± 50 mV																												
+5V	5000 mV	± 200 mV																												
+15V	1500 mV	± 50 mV																												
-15V	1500 mV	± 50 mV																												
Geiger HV	550 V	± 30 V																												
Ref. 2.5V	2500 mV	± 50 mV																												
Ref. RH	3660 mV	± 200 mV																												
Ref. A/D	2500 mV	± 50 mV																												
<p>– Tools required</p> <ul style="list-style-type: none"> <li>• None</li> </ul>																														




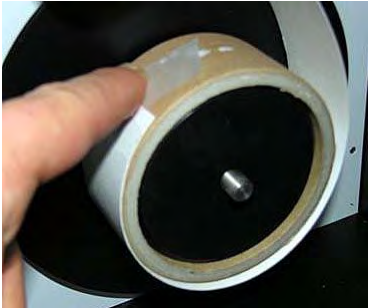
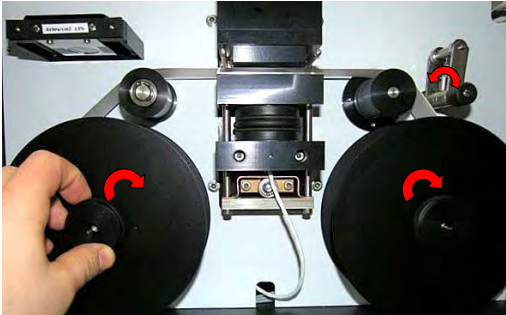
Page intentionally left blank




MAINTENANCE SHEET

<p><b>Monitor serial No.:</b></p>	<p><b>OPERATION SHEET : 4.3.5</b></p>	
<p><b>Scope : Filter ribbon replacement</b></p>	<p><b>PAGE : 1/3</b></p>	<p><b>Periodicity : de 1 to 3 years</b></p>
<p><u>Periodicity:</u> WHEN THE CONTROL  « FILTER → LOW LEVEL » IS DISPLAYED (1 TO 3 YEARS ACCORDING TO THE PROGRAMMED CYCLE DURATION).</p> <p><u>Procedure :</u></p> <p>1/ Stop any measurement in progress, if necessary.</p> <p>2/ Go to the first page of the « <i>Hardware function tests</i> » screen and make the plate moves down.</p> <p>3/ Open the door of the analyzer using the knurled button located on the left.</p> <p>4/ Lift up the pinch roller.</p>  <p>5/ Unscrew the stop button and remove the end plates of the take-up and pay-out reels.</p>    <p>6/ Remove the worn roll, recover the paperboard mandrel of the pay-out and place it on the take-up reel.</p>  		<p><b>Dates</b></p>
<p>– <b>Tools required</b></p> <ul style="list-style-type: none"> <li>• Filter paper roll, RF100 ref. M04-370-392</li> <li>• Adhesive tape</li> </ul>		

## MAINTENANCE SHEET

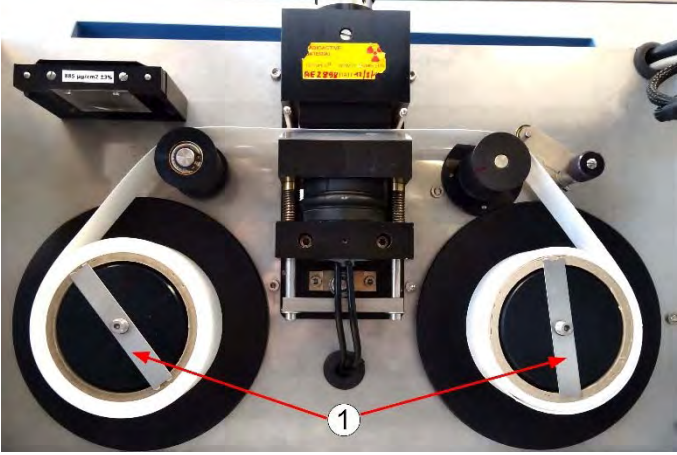
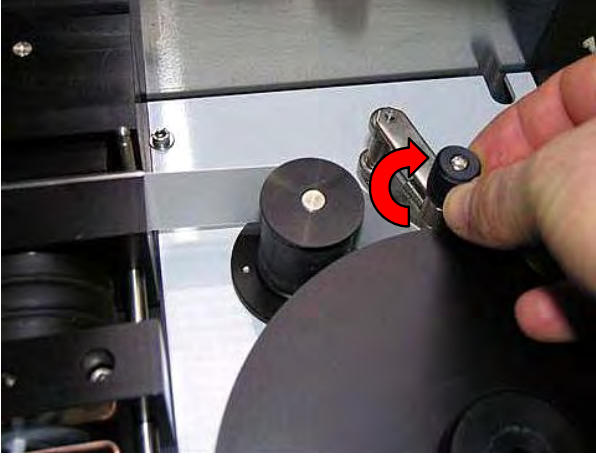
<b>Monitor serial No.:</b>	<b>OPERATION SHEET : 4.3.5</b>	
<b>Scope : Filter ribbon replacement</b>	<b>PAGE : 2/3</b>	<b>Periodicity : de 1 to 3 years</b>
<p><b>Periodicity:</b> WHEN THE CONTROL  « FILTER → LOW LEVEL » IS DISPLAYED (1 TO 3 YEARS ACCORDING TO THE PROGRAMMED CYCLE DURATION).</p> <p>7/ Place the new reel on the pay-out wheel, in order to unroll the paper clockwise.</p> <p>8/ Unroll the filter ribbon towards the right side, above the two capstans and between the plate and the source block.</p>  <p>9/ Roll up the end of the filter ribbon around the mandrel of the take-up reel and settle it with adhesive tape. Replace the two fixing parts of the reels.</p>   <p>10/ Close back the end plates with the stop buttons, slightly strain the ribbon and pull down the disengageable pinch roller.</p> 		<p><b>Dates</b></p>
<p>– Tools required</p> <ul style="list-style-type: none"> <li>• Filter paper roll, RF100 ref. M04-370-392</li> <li>• Adhesive tape</li> </ul>		

## MAINTENANCE SHEET

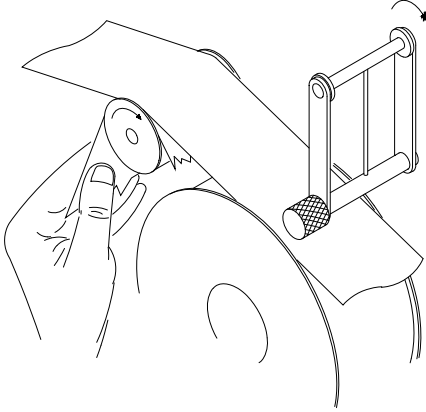
Monitor serial No.:	OPERATION SHEET : 4.3.5	
Scope : Filter ribbon replacement	PAGE : 3/3	Periodicity : de 1 to 3 years
<p>Periodicity: WHEN THE CONTROL  « FILTER → LOW LEVEL » IS DISPLAYED (1 TO 3 YEARS ACCORDING TO PROGRAMMING OF THE CYCLE DURATION).</p> <p>11/ It is now necessary to reset the counter of paper end autonomy: go to the first page of the « <i>Advanced analyzer configuration</i> » screen and switch ON the Reel / Init. Counter field. The spot number is reset to 1200.</p> <p>12/ After each replacement of ribbon filter, it is strongly advised to :</p> <ul style="list-style-type: none"> <li>- Check the pressure on the filter ribbon.</li> <li>- Calibrate the Beta gauge.</li> </ul>		<b>Dates</b>
<ul style="list-style-type: none"> <li>- <b>Tools required</b> <ul style="list-style-type: none"> <li>• Filter paper roll, RF100 ref. M04-370-392</li> <li>• Adhesive tape</li> </ul> </li> </ul>		

Page intentionally left blank

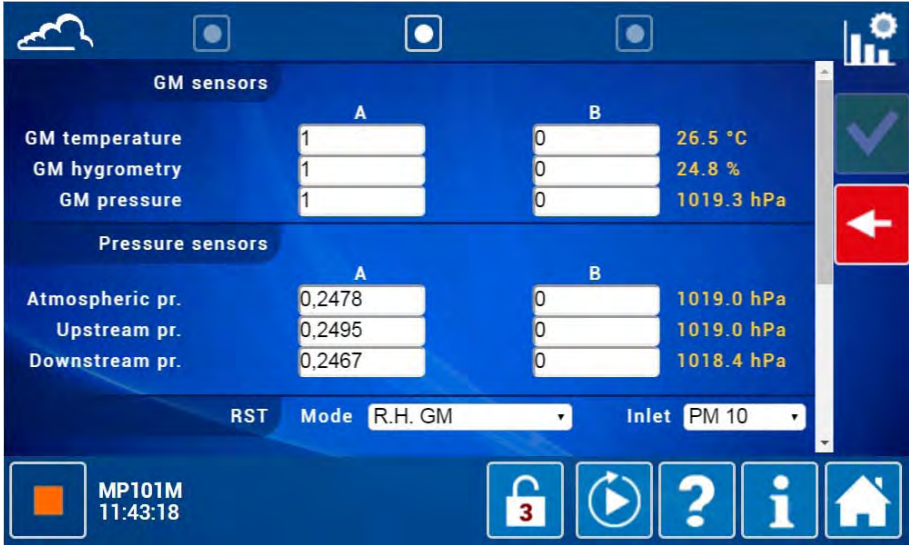
## MAINTENANCE SHEET

<b>Monitor serial No.:</b>	<b>OPERATION SHEET : 4.3.6</b>	
<b>Scope : Checking of the pressure exerted on the filter</b>	<b>PAGE : 1/2</b>	<b>Periodicity : 1 year</b>
<p><u>Procedure :</u></p> <p>1/ Stop any measurement in progress, if necessary, and check that the two fixing parts (1) of the reels are present (see here-below picture).</p>  <p>2/ Go to the first page of the « <i>Hardware function tests</i> » screen and move down the plate.</p> <p>3/ Open the analyzer door using the knurled button located on the left.</p> <p>4/ Raise the disengageable pinch roller.</p> 		<b>Dates</b>
<p>– <b>Tools required</b></p> <ul style="list-style-type: none"> <li>• None</li> </ul>		

## MAINTENANCE SHEET


<b>Monitor serial No.:</b>	<b>OPERATION SHEET : 4.3.6</b>	
<b>Scope : Checking of the pressure exerted on the filter</b>	<b>PAGE : 2/2</b>	<b>Periodicity : 1 year</b>
<p>5/ Insert a "smooth" paper between the filter ribbon and the driving capstan (the right one). Only the capstan rotation must cause the moving on of the ribbon filter (see the below picture).</p>  <p>6/ In the first page of the « <i>Hardware function tests</i> » screen, make the paper moves on continuously.</p> <p>7/ Keep in position the paper (inserted between the ribbon and the capstan) to prevent its driving on by the capstan.</p> <p>8/ Check that the filter ribbon does not move while the capstan is turning. If this is the case, then the pressure on the ribbon is correct.</p> <p>If the filter ribbon moves while the capstan is turning, then adjustments need to be made to the clutch of the take-up reel and/or the pay-out reel. Note that adjustment of the pay-out reel pressure may be more important than that of the take-up reel.</p> <p>Example :</p> <ul style="list-style-type: none"> <li>- If the filter ribbon is too much strained (which could tear).</li> <li>- The cause may be due to too tight pay-out reel. In this case :             <ul style="list-style-type: none"> <li>• Open the analyzer cover.</li> <li>• Loosen the clutch of the pay-out reel (knurled button and spring).</li> <li>• Do again the advance paper test.</li> </ul> </li> </ul> <p>9/ Remove the paper located between the capstan and the ribbon.</p> <p>10/ Put back in place the disengageable pinch roller.</p>		<p style="text-align: center;"><b>Dates</b></p>
<ul style="list-style-type: none"> <li>- <b>Tools required</b> <ul style="list-style-type: none"> <li>• None</li> </ul> </li> </ul>		

MAINTENANCE SHEET


<p>Monitor serial No.:</p>	<p>OPERATION SHEET : 4.3.7</p>	
<p>Scope : Checking of temperature, pressure and humidity sensors</p>	<p>PAGE : 1/4</p>	<p>Periodicity : 3 months</p>
<p>It is recommended to control these sensors at least once a year. But the ideal periodicity is on every season change if the temperature and relative humidity variations are important.</p>		<p>Dates</p>
<p>Pressure sensor checking :</p>		
<p>The pump must be OFF during this checking.</p>		
<p>– Write down (record) the atmospheric pressure value indicated on the reference barometer.                  – Then, go to the second page of the « <i>Advanced analyzer configuration</i> » screen and check the three yellow-displayed pressure values: « Atmospheric pr. », « Upstream pr. » and « Downstream pr. ».</p>		
		
<p>– The difference between each of these pressures and the reference pressure must be less than 1 mbar (absolute value).                  If the difference is greater, carry out a sensor calibration.</p>		
<p>– <b>Tools required</b></p> <ul style="list-style-type: none"> <li>• Reference barometer</li> <li>• Reference hygrometer</li> <li>• Reference thermometer</li> </ul>		



## MAINTENANCE SHEET


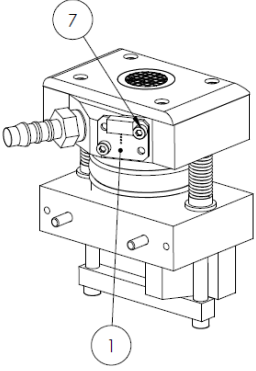
<b>Monitor serial No.:</b>		<b>OPERATION SHEET : 4.3.7</b>	
<b>Scope : Checking of temperature, pressure and humidity sensors</b>		<b>PAGE : 2/4</b>	<b>Periodicity : 3 months</b>
<p>It is recommended to control these sensors at least once a year. But the ideal periodicity is on every season change if the temperature and relative humidity variations are important.</p> <p><u>Check of atmospheric temperature and relative humidity sensors</u></p> <p>The RST function must be activated for this check (any possible control modes, "OFF" excepted).</p> <ul style="list-style-type: none"> <li>– Write down (record) the values of atmospheric temperature and relative humidity read on the reference sensors.</li> <li>– Then, go to the second page of the « <i>Advanced analyzer configuration</i> » screen, and check the yellow-displayed values of « Atmospheric T.» and « Relative hydr. ».</li> <li>– The difference between the displayed value and the reference value must be :</li> <li>– <b>lower than 2°C</b> (absolute value) for the atmospheric temperature</li> <li>– <b>lower than 5%</b> (absolute value) for relative humidity</li> </ul>			<p><b>Dates</b></p>
			
<p>If the difference is greater, carry out a sensor calibration.</p>			
<ul style="list-style-type: none"> <li>– <b>Tools required</b> <ul style="list-style-type: none"> <li>• Reference barometer</li> <li>• Reference hygrometer</li> <li>• Reference thermometer</li> </ul> </li> </ul>			

MAINTENANCE SHEET

<p>Monitor serial No.:</p>	<p>OPERATION SHEET : 4.3.7</p>	
<p>Scope : Checking of temperature, pressure and humidity sensors</p>	<p>PAGE : 3/4</p>	<p>Periodicity : 3 months</p>
<p>It is recommended to control these sensors at least once a year. But the ideal periodicity is on every season change if the temperature and relative humidity variations are important.</p> <p>Check of the « Head temperature » sensor</p> <p>The RST line must be uninstalled and placed close to the MP101M. If necessary, wait for 15 minutes after uninstalling before caring out the check (in order to stabilize the temperature of the mechanical line parts).</p> <p>The RST line must be electrically linked to MP101M with its two cables. The RST function must be activated (any possible control modes, "OFF" and "ALWAYS" excepted). The heating must not be activated (if necessary, modify the « Hygro. threshold » and « T. offset » T parameters.</p> <ul style="list-style-type: none"> <li>- Write down (record) the temperature value read on the reference sensor placed closed to the sampling line.</li> <li>- Then, go to the second page of the « <i>Advanced analyzer configuration</i> » screen and check the yellow-displayed values of « Atmospheric T. » and « Head T. » :             <ul style="list-style-type: none"> <li>• The difference between the « Atmospheric T. » sensor value and the reference sensor value must be lower than 2°C (absolute value),</li> <li>• The difference between the « Head T. » sensor value and the reference sensor value must be lower than 2°C (absolute value)</li> <li>• The difference between the two « Atmospheric T. » and « Head T. » sensor values must be lower than 2°C (absolute value).</li> </ul> </li> </ul> 		<p>Dates</p>
<ul style="list-style-type: none"> <li>- <b>Tools required</b> <ul style="list-style-type: none"> <li>• Reference barometer</li> <li>• Reference hygrometer</li> <li>• Reference thermometer</li> </ul> </li> </ul>		

If the difference is greater, carry out a sensor calibration.

## MAINTENANCE SHEET

<b>Monitor serial No.:</b>	<b>OPERATION SHEET : 4.3.7</b>	
<b>Scope : Checking of temperature, pressure and humidity sensors</b>	<b>PAGE : 4/4</b>	<b>Periodicity : 3 months</b>
<p><b>It is recommended to control these sensors at least once a year. But the ideal periodicity is on every season change if the temperature and relative humidity variations are important.</b></p> <p><u>Checking of GM sensors : temperature, humidity and pressure</u></p> <p><b>The analyzer cover must be removed for more than 15 min.</b></p> <p><b>The analyzer must not be mechanically linked to the RST line and pump must be OFF.</b></p> <p><b>The analyzer must be powered on for less than 15 min.</b></p> <ul style="list-style-type: none"> <li>- Write down (record) the temperature, relative humidity and atmospheric pressure values read on the reference sensors placed close to the analyzer.</li> <li>- Go to the second page of the « <i>Advanced analyzer configuration</i> » screen and compare the yellow-displayed « GM temperature », « GM hygrometry » and « GM pressure » values with the reference sensor measurements.</li> <li>- The difference between the displayed value and the reference value must be :             <ul style="list-style-type: none"> <li>• Lower than 2°C (absolute value) for the temperature,</li> <li>• Lower than 5% (absolute value) for the relative humidity,</li> <li>• Lower than 1 mbar (absolute value) for pressure.</li> </ul> </li> </ul> <div style="display: flex; justify-content: space-around;">   </div> <ul style="list-style-type: none"> <li>- If the difference is greater, first, switch OFF the analyzer and dismount the "GM Sensors" board (1) from its holder, by removing the two screws (7) accessible from the rear of the analyzer. Then do again the comparison.</li> <li>- Once the board is disassembled from its holder, the analyzer may be again powered-on.</li> <li>- The test must be carried out taking up the board by its cable and placing the reference sensors close by.</li> </ul> <p><b>WARNING: an O-ring ensures tightness between the board and its holder. Be careful not to lose it and put it back in place after the test.</b></p> <p>If the measured difference remains greater than the tolerances, a sensor calibration must be carried out.</p>		<p align="center"><b>Dates</b></p>
<ul style="list-style-type: none"> <li>- <b>Tools required</b> <ul style="list-style-type: none"> <li>• Reference barometer</li> <li>• Reference hygrometer</li> <li>• Reference thermometer</li> </ul> </li> </ul>		


## MAINTENANCE SHEET

<b>Monitor serial No.:</b>	<b>OPERATION SHEET : 4.3.8</b>	
<b>Scope : Flow checking</b>	<b>PAGE : 1/1</b>	<b>Periodicity : 3 months</b>
<p><u>Procedure :</u></p> <p>This checking can be performed without stopping the measurement. The presence of two operators is recommended.</p> <p><u>1/ FLOW TEST :</u></p> <ul style="list-style-type: none"> <li>- Connect a flowmeter on the sampling line using the adaptor P10-2186.</li> <li>- Go to the « <i>Flow calibration</i> » screen.</li> <li>- Check that the flow measured by the reference flow meter meets the flow measured by the analyzer.</li> <li>- If the flow rate read on the flowmeter is not comprised within 15.8 L / min and 17.5 L / min, stop the measurement, then carry out a flow calibration.</li> </ul>		<b>Dates</b>
<ul style="list-style-type: none"> <li>- <b>Tools required</b> <ul style="list-style-type: none"> <li>• Reference flow meter (with reduced pressure loss)</li> <li>• Flowmeter adaptor, ref.: P10-2186</li> <li>• O-ring spare, ref.: G06-027_0-2_0-V, to be placed under the retractable end piece, on the MP101M sample inlet.</li> </ul> </li> </ul>		

## MAINTENANCE SHEET

<b>Monitor serial No.:</b>	<b>OPERATION SHEET : 4.3.9</b>	
<b>Scope : Calibration of temperature, pressure and humidity sensors</b>	<b>PAGE : 1/4</b>	<b>Periodicity : 1 year</b>
<p><u>Pressure sensors calibration</u></p> <p><b>STOP the pump before doing this calibration.</b></p> <ul style="list-style-type: none"> <li>- Write down (record) the atmospheric pressure value read on the reference sensor.</li> <li>- Then, go to the second page of the « <i>Advanced analyzer configuration</i> » screen.</li> </ul> <div data-bbox="300 734 1214 1281" data-label="Image"> <p>The screenshot shows the 'Advanced analyzer configuration' screen for the MP101M. It is divided into two main sections: 'GM sensors' and 'Pressure sensors'. Each section has two columns, 'A' and 'B', for linearization coefficients. The 'GM sensors' section shows: GM temperature (A: 0,8391, B: 0, 22.4 °C), GM hygrometry (A: 1,1922, B: 0, 32.3 %), and GM pressure (A: 1,0002, B: 0, 1000.2 hPa). The 'Pressure sensors' section shows: Atmospheric pr. (A: 0,222, B: 106, 999.3 hPa), Upstream pr. (A: 0,222, B: 112, 999.6 hPa), and Downstream pr. (A: 0,222, B: 103, 999.9 hPa). At the bottom, there are controls for 'RST', 'Mode' (set to OFF), and 'Inlet' (set to PM 10). A status bar at the bottom left shows 'MP101M 15:50:18' and a lock icon with the number 3. Navigation icons for back, play, help, info, and home are also present.</p> </div> <ul style="list-style-type: none"> <li>- On the « Atmospheric pr. » line :             <ul style="list-style-type: none"> <li>• Check that the linearization coefficient A is equal to 0.222,</li> <li>• Adjust the coefficient B so that the upstream pressure equals the reference sensor pressure with a tolerance of +/- 1 mbar.</li> </ul> </li> <li>- Repeat these operations for the « Upstream pr. » and « Downstream pr. ».</li> </ul> <p><b>WARNING: the three pressure sensor linearization coefficients are not necessarily identical.</b></p>		<p><b>Dates</b></p>
<ul style="list-style-type: none"> <li>- <b>Tools required</b> <ul style="list-style-type: none"> <li>• Reference barometer</li> <li>• Reference hygrometer</li> <li>• Reference thermometer</li> </ul> </li> </ul>		

## MAINTENANCE SHEET

Monitor serial No.:	OPERATION SHEET : 4.3.9	
Scope : Calibration of temperature, pressure and humidity sensors	PAGE : 2/4	Periodicity : 1 year
<p><u>Calibration of the atmospheric temperature and relative humidity sensors</u></p> <p><b>The RST function must be activated (any possible control modes, «OFF» excepted)</b></p> <p><b>For this calibration step, which requires several hours of continuous analyzer operation, reference sensors for atmospheric temperature and relative humidity must be installed on the site or nearby (for instance : sensors of meteo station or another analyzer ...).</b></p> <p><b>It is required to recover these sensor data in order to compare them with the MP101M data.</b></p> <ul style="list-style-type: none"> <li>- In the « <i>General configuration (Address, Protocol, Measurement channels...)</i> » screen: <ul style="list-style-type: none"> <li>• Select an « Archive period » = 1 min.</li> <li>• Add the measurement channels « Rel. hydr. » and « Atmo. T. » if they are not activated yet.</li> </ul> </li> <li>- If the analyzer is not in measurement mode yet: touch / click on .</li> <li>- Recover the stored data of the two measurement channel « Rel. hydr.» (%) and « Atmo. T. » after some hours operation.</li> <li>- Check that the atmospheric temperature variation range is about 10°C for this period and the relative humidity variation range exceeds 10%.</li> <li>- For atmospheric temperature and relative humidity independently : <ul style="list-style-type: none"> <li>• Plot the point curve <math>y = f(x)</math> where <math>y</math> = reference sensor and <math>x</math> = RST sensor, for all the considered period.</li> <li>• Then plot the regression curve.</li> <li>• And deduce from its equation the linearization coefficients A (= regression curve slope) and B (= regression curve offset) of the RST sensor.</li> </ul> </li> <li>- Then enter these new coefficients A and B for each sensors in the second page of the « <i>Advanced analyzer configuration</i> » screen.</li> </ul>		<b>Dates</b>
<ul style="list-style-type: none"> <li>- <b>Tools required</b> <ul style="list-style-type: none"> <li>• Reference barometer</li> <li>• Reference hygrometer</li> <li>• Reference thermometer</li> </ul> </li> </ul>		



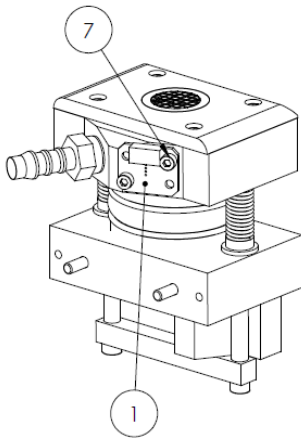
## MAINTENANCE SHEET

<b>Monitor serial No.:</b>	<b>OPERATION SHEET : 4.3.9</b>	
<b>Scope : Calibration of temperature, pressure and humidity sensors</b>	<b>PAGE : 3/4</b>	<b>Periodicity : 1 year</b>
<p><u>Calibration of the « Head temperature » sensor</u></p> <p>The simplest solution is to apply the coefficients A and B found for the « Atmospheric temperature » to the « Head temperature » sensor.</p> <p>Indeed, the two sensors are identical (same reference) and supplied from the same voltage source.</p> <p>Or, follow the procedure described below:</p> <p><b>The RST line must be uninstalled and placed close to the MP101M. If necessary, wait for 15 minutes after uninstalling before carrying out the calibration (for temperature stabilization of the mechanical parts).</b></p> <p><b>The RST line must be electrically connected to MP101M by its cables, the RST function must be activated (any possible control modes, "OFF" and "ALWAYS" excepted), the heater must not be activated (if necessary, change the H and T parameters consequently).</b></p> <ul style="list-style-type: none"> <li>- Write down (record) the temperature value on the reference sensor placed close to the sampling line.</li> <li>- Then go to the second page of the « <i>Advanced analyzer configuration</i> », screen and check the « Head T. » yellow-displayed value.</li> </ul> <div data-bbox="375 1021 1136 1476" data-label="Image"> </div> <ul style="list-style-type: none"> <li>- Check that the coefficient A is equal to 0.1 +/- 0.05.</li> <li>- Adjust the coefficient value B so that the difference between this displayed sensor value and the displayed reference thermometer value be lower than 2°C in absolute value.</li> <li>- Also check that the difference between the displayed value for the « Atmospheric T. » sensor and the displayed value for « Head T. » sensor is lower than 2°C in absolute value.</li> </ul>		<p><b>Dates</b></p>
<ul style="list-style-type: none"> <li>- <b>Tools required</b> <ul style="list-style-type: none"> <li>• Reference barometer</li> <li>• Reference hygrometer</li> <li>• Reference thermometer</li> </ul> </li> </ul>		



## MAINTENANCE SHEET

Monitor serial No.:	OPERATION SHEET : 4.3.9	
Scope : Calibration of temperature, pressure and humidity sensors	PAGE : 4/4	Periodicity : 1 year
<p><u>Calibration of GM sensors: temperature, humidity and pressure</u></p> <p><b>Remove the analyzer cover and switch OFF the pump.</b></p> <ul style="list-style-type: none"> <li>– Switch OFF the analyzer.</li> <li>– Dismount the « GM sensor » board (1) from its holder, by unscrewing the two screws (7) accessible by the rear analyzer panel.</li> <li>– Once the board is disassembled from its holder, the analyzer can be powered on again.</li> <li>– Then, the test must be carried out holding the board up by its cable and placing the reference sensors nearby.</li> </ul> <p><b>WARNING:</b></p> <p>1 – An O-ring ensures tightness between the board and its holder. Be careful not to lose it and place it back after the test.</p> <p>2 – Do not blow on the sensor in order not to distort its measurements</p> <ul style="list-style-type: none"> <li>– Go to the second page of the « <i>Advanced analyzer configuration</i> » screen.</li> <li>– For the three sensors, adjust the value B so that the difference between the displayed measurement and the reference sensor measurement be: <ul style="list-style-type: none"> <li>• <b>lower than 2°C</b> (absolute value) for temperature,</li> <li>• <b>lower than 5%</b> (absolute value) for relative humidity,</li> <li>• <b>lower than 1 mbar</b> (absolute value) for pressure.</li> </ul> </li> </ul>		<p style="text-align: center;"><b>Dates</b></p>
<ul style="list-style-type: none"> <li>– <b>Tools required</b> <ul style="list-style-type: none"> <li>• Reference barometer</li> <li>• Reference hygrometer</li> <li>• Reference thermometer</li> </ul> </li> </ul>		



## MAINTENANCE SHEET

<b>Monitor serial No.:</b>		<b>OPERATION SHEET : 4.3.10</b>	
<b>Scope : Aspiration flow calibration</b>		<b>PAGE : 1/1</b>	<b>Periodicity : 1 year</b>
<p><u>Procedure :</u>                  Refer to paragraph 3.4.2.14. Flow calibration, of chapter 3.</p> <p><b>It is recommended to carry out a flow rate calibration :</b></p> <ul style="list-style-type: none"> <li>- Once a year,</li> <li>- On the first analyzer start-up,</li> <li>- When the flow rate test does not provide correct results.</li> </ul>			<b>Dates</b>
<p>- <b>Tools required</b></p> <ul style="list-style-type: none"> <li>• Reference flowmeter</li> <li>• Flowmeter adaptor on channel, Ref. : P10-2186, or flowmeter adaptor on MP101M, Ref.: P10-2187.</li> </ul>			

## MAINTENANCE SHEET

Monitor serial No.:	OPERATION SHEET : 4.3.11	
Scope : Leak test	PAGE : 1/2	Periodicity : 1 year
<p>It is recommended to check the whole air circuit tightness (sampling line, measurement system). For that, it will be better to use the flowmeter adaptor on RST tube, ref. P10-2186. It is equipped with a tap that will be used as shutter during checking.</p> <p>It is also possible to test only the measurement system tightness using the flowmeter adaptor on MP101M, ref.: P10-2187.</p> <ul style="list-style-type: none"> <li>- Go to the fourth page « Leak test » of the « <i>Hardware functions tests</i> » screen.</li> <li>- Follow the leak test procedure described in chapter 3, section 3.4.2.12.</li> </ul>		<p style="text-align: center;">Dates</p>
<ul style="list-style-type: none"> <li>- <b>Tools required</b> <ul style="list-style-type: none"> <li>• Flowmeter adaptor on RST tube, ref. : P10-2186 (recommended),</li> <li>• Or, flowmeter adaptor on MP101M, ref.: P10-2187.</li> </ul> </li> </ul>		

## MAINTENANCE SHEET

<b>Monitor serial No.:</b>	<b>OPERATION SHEET : 4.3.12</b>	
<b>Scope : Gauge calibration</b>	<b>PAGE : 1/1</b>	<b>Periodicity : 1 year</b>
<p><u>Procedure :</u> Refer to paragraph 3.4.2.13. of chapter 3, Gauge calibration.</p> <p><b>It is recommended to carry out a Beta gauge calibration :</b></p> <ul style="list-style-type: none"> <li>- Once a year,</li> <li>- On the first analyzer start-up,</li> <li>- After replacement of the filter paper ribbon,</li> <li>- After Geiger-Müller detector replacement,</li> <li>- After radioactive source replacement,</li> <li>- When a mass test does not provide correct results.</li> </ul>		<b>Dates</b>
<ul style="list-style-type: none"> <li>- Tools required                             <ul style="list-style-type: none"> <li>• Reference gauge, ref. M04-0004-B-SAV, or automatic calibration option.</li> </ul> </li> </ul>		


## MAINTENANCE SHEET

<b>Monitor serial No.:</b>	<b>OPERATION SHEET : 4.3.13</b>	
<b>Scope : Automatic contamination test</b>	<b>PAGE : 1/1</b>	<b>Periodicity : 3 months</b>
<p>This test allows to check the measurement system non-contamination. The source is kept in aspiration position during this test.</p> <p><u>PROCEDURE :</u></p> <p>It is possible to let the MP101M automatically and periodically perform this test by switching ON the « Contamination test » field in the first page of the « <i>Advanced analyzer configuration</i> » screen. (See paragraph 3.4.2.11. of chapter 3, <i>Advanced analyzer configuration</i>). Periodicity is counted in cycle number. The Contamination test result is memorized in the « Contam. » channel if this channel was firstly activated in the « <i>General configuration (Address, Protocol, Measurement channels...)</i> » screen (see paragraph 3.4.2.2. of chapter 3).</p>		<b>Dates</b>
<p>– <b>Tools required</b></p> <ul style="list-style-type: none"> <li>• None</li> </ul>		

## MAINTENANCE SHEET





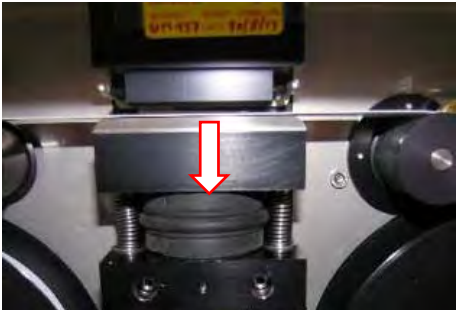
Monitor serial No.:	OPERATION SHEET : 4.3.14	
Scope : Beta gauge check (gauge test, mass test)	PAGE : 1/1	Periodicity : 1 year
<p><u>1/ Gauge test</u></p> <p>Carry out a gauge test following the instructions described in the second page of the « <i>Hardware function tests</i> » screen.</p> <p>Chose a recurrence equal to five.</p> <p>At the test end, check the following values :</p> <ul style="list-style-type: none"> <li>– <b>Average measurement:</b> check that the absolute value of the measurement remains lower than 10 µg/cm<sup>2</sup>.</li> <li>– <b>Standard-deviation:</b> check that the standard deviation remains lower than 10 µg/cm<sup>2</sup>.</li> </ul> <p>If the test is not satisfying, repeat it (no more than three times).</p> <p>If the detector is too noisy, it probably needs to be replaced.</p> <p><u>2/ Mass test</u></p> <p>Carry out a mass test by following the instructions described in the third page of the « <i>Hardware function tests</i> » screen.</p> <p>Set a recurrence comprised within 5 and 10.</p> <p>At the test end, check the following values :</p> <ul style="list-style-type: none"> <li>– <b>Average measurement:</b> check that the measurement value is near to the value indicated on the reference gauge (<math>  \text{Measurement} - \text{Reference gauge value}   \leq 25 \mu\text{g}/\text{cm}^2</math>).</li> <li>– <b>Standard deviation:</b> check that the standard deviation remains lower than 15 µg/cm<sup>2</sup>.</li> </ul> <p>If the test is not satisfying, repeat it.</p> <p>After the second not-satisfying test, carry out a new Beta gauge calibration.</p>		<b>Dates</b>
<ul style="list-style-type: none"> <li>– <b>Tools required</b> <ul style="list-style-type: none"> <li>• Reference gauge, ref. M04-0004-B-SAV, or automatic calibration option.</li> </ul> </li> </ul>		

## MAINTENANCE SHEET

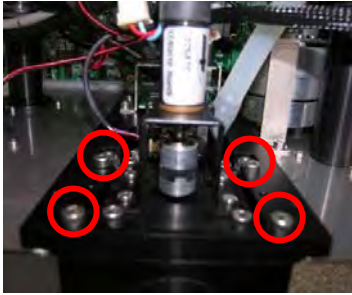
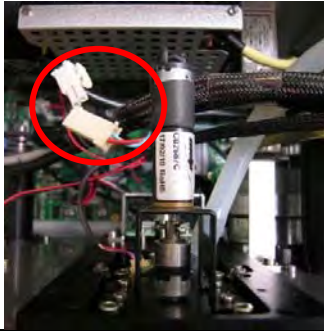

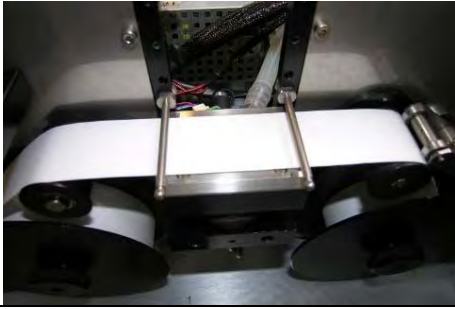
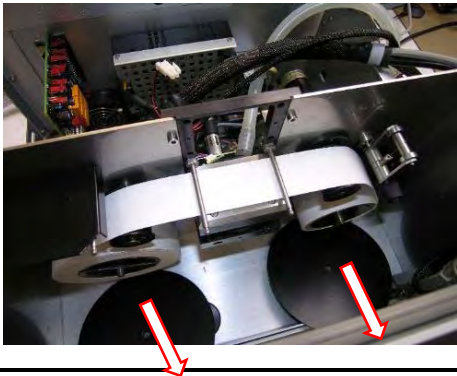
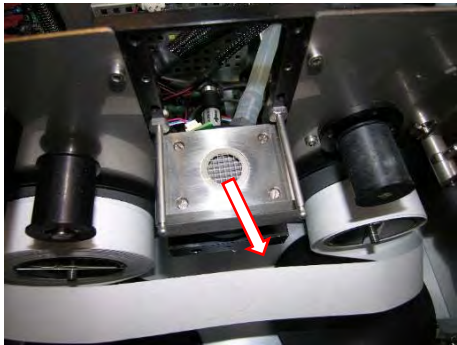
Monitor serial No.:	OPERATION SHEET : 4.3.15	
Scope : Checking of zero point measurement	PAGE : 1/1	Periodicity : 1 year
<p><b>This checking requires the HEPA filter (P10-2195) installation on the analyzer sample inlet. It is advised to use a flowmeter adaptor (P10-2187) on MP101 to connect the HEPA filter without leak risk.</b></p> <p><u>Procedure :</u></p> <ul style="list-style-type: none"> <li>– Go to the fifth page of the « <i>Hardware function test</i> » screen.</li> <li>– Follow indications given in paragraph 3.4.2.12. of chapter 3 to configure the test.</li> <li>– The recommended configuration is the following : <ul style="list-style-type: none"> <li>• Cycle duration : 48h</li> <li>• Period duration : 2h</li> <li>• Test duration : 24 periods</li> <li>• First measurement to be excluded : between 0 and 2</li> <li>• Maximum average : 3 µg/m<sup>3</sup></li> <li>• Maximum standard deviation : 3 µg/m<sup>3</sup></li> </ul> </li> <li>– Configure the start type in the first page of the « <i>Advanced analyzer configuration</i> » screen.</li> <li>– Start up the measurement by touching / clicking on .</li> </ul> <p>At test end, the measurement automatically stops. It is then possible to visualize the test result and its report in the fifth page of the « <i>Hardware function test</i> » screen</p> <p>It is also possible to download the stored data via the measurement channel « Per. Conc.».</p>		<b>Dates</b>
<ul style="list-style-type: none"> <li>– <b>Tools required</b> <ul style="list-style-type: none"> <li>• Flowmeter adaptor on MP101, ref. : P10-2187,</li> <li>• associated to the zero particle filter for MP101, ref.: P10-2195.</li> </ul> </li> </ul>		



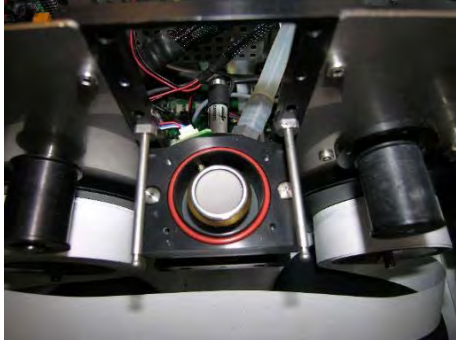

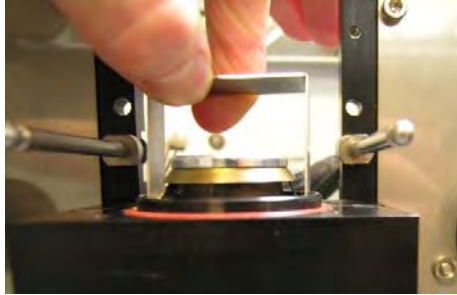


## MAINTENANCE SHEET

<b>Monitor serial No.:</b>		<b>OPERATION SHEET : 4.3.16</b>		
<b>Scope : Geiger Muller (GM) tube replacement</b>		<b>PAGE : 1/5</b>	<b>Periodicity: if fault detected</b>	
<p><u>OPERATING MODE</u></p> <p>A/ Prepare the new GM tube</p>			<b>Dates</b>	
<p>A.1. Open the box and the black package of the GM tube:</p> <p><b>CAUTION:</b></p> <ul style="list-style-type: none"> <li>- <b>Never put your fingers on the grey surface of the GM tube.</b></li> <li>- <b>Never blow on this surface.</b></li> </ul> <p><b>Avoid dust deposition on this surface.</b></p>				
<p>A.2. Take the GM tube out of its black package:</p> 	<p>A.3. Unplug the anode clip as shown here:</p> 	<p>A.4. Cut the cathode lead as shown here:</p> 		
<p>B/ Remove the old GM tube</p> <p>B.1. Stop the measurement cycles of the MP101M.</p> <p>B.2. In the first page of the «Hardware functions tests» screen:</p> <ul style="list-style-type: none"> <li>- Activate the source motor and put it in the sampling position (refer to chapter 3). This procedure will assure that the source is in the correct position for the replacement of the GM tube.</li> <li>- Activate the plate motor and put it in the low position (refer to chapter 3).</li> <li>- Verify that the plate goes correctly in the low position:</li> </ul>				
<p>- <b>Tools required</b></p> <ul style="list-style-type: none"> <li>• Screwdriver</li> <li>• Hex keys</li> <li>• Geiger Muller tube : M02-5224</li> <li>• Water protection ring : P02-2180</li> <li>• Replacement tool: P05-2197</li> </ul>				




MAINTENANCE SHEET

Monitor serial No.:		OPERATION SHEET : 4.3.16	
Scope : Geiger Muller (GM) tube replacement		PAGE : 2/5	Periodicity: if fault detected
<p>B.3. Switch off the MP101M and unplug it from the power supply.</p> <p>B.4. Unscrew and remove the cover of the MP101M.</p>			Dates
<p>B.5. Unscrew the four M4 screws that are used to fix the source assembly:</p> 	<p>B.6. Unplug the cable of the source motor:</p> 		
<p>B.7. Pull and remove the source assembly:</p>  			
<p>B.8. Move carefully the filter towards the front of the analyzer, in order to access the GM tube:</p> 	<p>B.9. Move carefully the filter towards the front of the analyzer, in order to access the GM tube:</p> 		
<p>– <b>Tools required</b></p> <ul style="list-style-type: none"> <li>• Screwdriver</li> <li>• Hex keys</li> <li>• Geiger Muller tube : M02-5224</li> <li>• Water protection ring : P02-2180</li> <li>• Replacement tool: P05-2197</li> </ul>			

## MAINTENANCE SHEET

<b>Monitor serial No.:</b>		<b>OPERATION SHEET : 4.3.16</b>	
<b>Scope : Geiger Muller (GM) tube replacement</b>		<b>PAGE : 3/5</b>	<b>Periodicity: if fault detected</b>
<p>B.10. Unscrew and remove the plate with the grid from the top of the GM tube:</p> 			<b>Dates</b>
<p>B.11. Use the tool P05-2197 in order to remove the GM tube. Push strong the tool until the 2 clips go below the ring:</p> 			
<p>B.12. Then pull vertically and carefully, in order to move up the GM tube and the ring. <b>Stop after about 1 cm:</b></p> 			
<p>B.13. Then remove the tool. Take the GM tube in your fingers and move it vertically until being able to unplug it from the red cable:</p>  			
<p>– <b>Tools required</b></p> <ul style="list-style-type: none"> <li>• Screwdriver</li> <li>• Hex keys</li> <li>• Geiger Muller tube : M02-5224</li> <li>• Water protection ring : P02-2180</li> <li>• Replacement tool: P05-2197</li> </ul>			

MAINTENANCE SHEET

<b>Monitor serial No.:</b>		<b>OPERATION SHEET : 4.3.16</b>	
<b>Scope : Geiger Muller (GM) tube replacement</b>		<b>PAGE : 4/5</b>	<b>Periodicity: if fault detected</b>
<p><u>C/ Install the new GM tube</u></p> <div style="display: flex; justify-content: space-between;"> <div style="width: 45%;"> <p>C.1. Put the water protection ring P02-2180 around the new GM tube:</p>  </div> <div style="width: 45%;"> <p>C.2. Do not forget to connect the GM tube to the red cable before the complete insertion in the GM holder:</p>  </div> </div> <p><b>NOTE: The ground wire of the GM tube should be in continuous contact with the GM holder. Do not place this ground wire along one of the slits of the holder:</b></p> <div style="display: flex; justify-content: space-between; align-items: center;">  <div style="border: 1px solid black; padding: 5px; width: 30%;"> <p><b>One slit of the GM holder:</b> DO NOT PUT THE GROUND WIRE ALONG ONE OF THESE SLITS!</p> </div> </div> <p>C.3. Push completely the GM tube in its holder without touching the grey surface.</p>			<p><b>Dates</b></p>
<p>– <b>Tools required</b></p> <ul style="list-style-type: none"> <li>• Screwdriver</li> <li>• Hex keys</li> <li>• Geiger Muller tube : M02-5224</li> <li>• Water protection ring : P02-2180</li> <li>• Replacement tool: P05-2197</li> </ul>			



## MAINTENANCE SHEET

<b>Monitor serial No.:</b>	<b>OPERATION SHEET : 4.3.16</b>	
<b>Scope : Geiger Muller (GM) tube replacement</b>	<b>PAGE : 5/5</b>	<b>Periodicity: if fault detected</b>
<p><u>D/ Start and test the new GM tube</u></p> <p>D.1. <u>Put all the parts back</u>: plate with grid, filter roll, source assembly. Do not forget to re-connect also the cable of the source motor.</p> <p>D.2. Put back and fix the cover of the MP101M. Plug the MP101M to the power supply.</p> <p>D.3. <u>Switch ON the MP101M and proceed as followed</u>:</p> <ul style="list-style-type: none"> <li>– Go to the first page of the menu “Hardware functions tests”.</li> <li>– Activate the plate motor and put in its high position (refer to chapter 3).</li> <li>– Activate the source motor and put it in its measurement position (refer to chapter 3).</li> <li>– Activate the high voltage supply of the GM tube: the value of the voltage will be displayed automatically, together with the raw counting of the GM tube (in c/s).</li> <li>– <b>Verify that the raw counting value is higher than 2 000 c/s and record the average value.</b></li> </ul> <p>D.4. Go to the second page of the menu “Hardware functions tests” in order to start a gauge test:</p> <ul style="list-style-type: none"> <li>– <b>Choose a value of Recurrence = 35.</b></li> <li>– <b>Start the gauge test (refer to chapter 3).</b></li> </ul> <p><b>The gauge test should last about 6 hours. During this test, the GM tube counting rate should stabilize.</b></p> <p>D.5. At the end of the test:</p> <ul style="list-style-type: none"> <li>– Go back to the first page of the menu “Hardware functions tests”.</li> <li>– Activate the plate motor and put in its high position (refer to chapter 3).</li> <li>– Activate the source motor and put it in its measurement position (refer to chapter 3).</li> <li>– Activate the high voltage supply of the GM tube: the value of the voltage will be displayed automatically, together with the raw counting of the GM tube (in c/s).</li> <li>– Verify that the raw counting value is lower than initially and stays between 2000 and 6500 c/s.</li> </ul> <p>D.6. Make a Beta Gauge calibration using the menu “Gauge calibration” (refer to chapter 3)</p> <p>D.7. Make a Mass Test in the third page of the menu “Hardware functions tests” (configured with at least a recurrence = 5, refer to chapter 3), to be sure that the GM tube works correctly. The difference between the “reference gauge” value and the “average measurement” displayed in the report of the mass test should be lower than 25 µg/m<sup>3</sup> in absolute value.</p> <p>D.8. If everything is working fine, you can start the measurement cycle.</p>		<b>Dates</b>
<ul style="list-style-type: none"> <li>– <b>Tools required</b> <ul style="list-style-type: none"> <li>• Screwdriver</li> <li>• Hex keys</li> <li>• Geiger Muller tube : M02-5224</li> <li>• Water protection ring : P02-2180</li> <li>• Replacement tool: P05-2197</li> </ul> </li> </ul>		

## 4.4. EQUIPMENT NECESSARY FOR MAINTENANCE

Designation	Reference	Quantity
<b>Kit of recommended spare parts</b>	<b>MP101-R-RSP</b>	
<b>This kit includes :</b>		
• Absolute pressure sensor board	C06-C12-0291	1
• GEIGER-MULLER tube	M02-5224	1
• Paper roll RF100, ref:10	M04-370-392	1
• LND removing tool	P05-2197	1
• O-ring, int. Ø:27 cord:2 Viton / gasket for sample inlet	G06-027_0-2_0-V	1
• GM sensor board	C06-0496	1
• THRP cable	D01-1309	1
• Hybrid seal	G05-AC-184413	1
• Source plate valve motor, wired	V01-0014	1
• Holding block	P06-2099	1

Designation	Reference	Quantity
<b>Maintenance kit KNF (1 an)</b>	<b>MP101-R-K2</b>	
<b>This kit includes :</b>		
• Paper roll RF100 ref:10 370 392	M04-370-392	1
• KNF pump maintenance kit (V02-0012-A)	V02-K-0012-A	1
• O-ring int. Ø:27 cord:2 Viton / gasket for sample inlet	G06-027_0-2_0-V	1
• O-ring Ø22 cord 2.5 Silicon / gasket for channel tightness system P10-2185	G06-022_0-2_5-S	2
• O-ring Ø38 cord 2.5 Silicon / gasket for channel tightness system P10-2185	G06-038_0-2_5-S	1











Designation	References	Quantity
<b>Maintenance kit PICOLINO (1 year)</b>	<b>MP101-R-K3</b>	
<b>This kit includes :</b>		
• Blue polyurethane tube o5x8	F04-TU-08-05	0.03
• Blue polyurethane tube 7x10	F04-TU-08-10	0.1
• WK 42 filtering cartridge	F05-WK-42-A	1
• RF100 paper roll, ref:10 370 392	M04-370-392	1
• Maintenance kit for VTE pump	SAV-K-000145-A	1
• O-ring int. Ø:27 cord:2 Viton / gasket for sample inlet	G06-027_0-2_0-V	1
• O-ring Ø22 cord 2.5 Silicon / gasket for tightness channel system P10-2185	G06-022_0-2_5-S	2
• O-ring Ø38 cord 2.5 Silicon / gasket for tightness channel system P10-2185	G06-038_0-2_5-S	1

**Other spare parts:**

Designation	References	Quantity
<b>GM tube kit</b>	<b>SAV-K-000251</b>	
• GEIGER-MULLER tube	M02-5224	1
• LND removing tool	P05-2197	1
<b>GM detector kit</b>	<b>SAV-K-000252</b>	
• Equipped GM detector without GM tube, V2	M02-5215	1
• Holding block	P06-2099	1
<b>Holding block kit</b>	<b>SAV-K-000253</b>	
• Holding block	P06-2099	1
• Compression spring ext. Ø 10, fil Ø 1.2, Length 47	G10-RE-0003	1
<b>THRP holder board kit</b>	<b>SAV-K-000254</b>	
• GM sensor board	C06-0496	1
• THRP cable	D01-1309	1



## 4.5. SPARE PART LIST WITH PICTURES

Component/ Reference	Designation	Pictures
<b>TOOLS QA/QC</b>		
P10-2186	Flowmeter adaptor on RST tube	
P10-2187	Flowmeter adaptor on MP101M	
P10-2195	Zero-particle filter for MP101	
F02-50-510-300	Flowmeter 6 to 50 l/mm GI 1/4"B	
M04-0004-B-SAV	MP101 REFERENCE GAUGE	
<b>FUSES</b>		
S01-TT03_15-A	Very time-delay fuse D1TD/3.15A o5x20	
S01-TT05_00-A	Very time-delay fuse D1TD/5A o5x20	
<b>FRONT PANEL</b>		
P10-2172	7" TFT Touch screen assembly	
C03-0476	ARM20 BOARD	
<b>DETECTOR PLATE ASSEMBLY</b>		
M02-5224	GEIGER-MULLER tube	
P05-2197	LND removing tool	
P02-2180	Water deflector	
M02-5215	Equipped GM detector without GM tube V2	

Component/ Reference	Designation	Pictures
P06-2099	Holding block	
G10-RE-0003	Compression spring ext. Ø 10, fil. Ø 1.2, Length 47	
C06-0496	GM sensor board	
D01-1309	THRP cable	
<b>SOURCE</b>		
M03-C14-SOURCE-C	C14 source – delivered if valid authorizations	
<b>SAMPLE INLET</b>		
P10-2185	MP101M tightness system (with 2 gaskets G06-022_0-2_5-S and 1 gasket G06-038_0-2_5-S)	
F09-5003	Retractable sampling inlet part	
G06-027_0-2_0-V	O-ring oint.:27 cord:2 Viton	
<b>MOTOR AND FILTER ASSELBLY</b>		
M04-370-392	RF100 paper roll, ref:10 370 392	
V01-0023	Wired paper motor 230VAC/50Hz	
V01-0024	Wired paper motor 115VAC/50Hz	
G05-BM-6T5	Notched belt, ref.6T5/305	
<b>FLOW RATE CONTROL ASSEMBLY</b>		
C06-C12-0291	"ROHS" absolute pressure sensor board	

Component/ Reference	Designation	Pictures
F02-0151	Flow rate control assembly	
<b>ELECTRONIC BOARDS</b>		
C01-0495	MP101M Module board	
C04-0494	MP101M power supply board	
C06-0493	High voltage board	
<b>VALVE – SOURCE – PLATE CLUTCH AND MOTOR</b>		
V01-0014	Wired valve-source-plate motor	
G05-AC-184413	Hybrid seal	
<b>RST ASSEMBLY</b>		
P10-1317	Mounted sensor assembly for RST tube	
M04-0045	T° humidity sensor connector assembly	
P01-0819	Sampling head tripod	
P10-1014	Mounting assembly of dust/gas sampling head	
<b>SAMPLING HEAD</b>		
X01-0026	Vacuum grease for sampling head PM10 and PM2.5 EN type	

## CHAPTER 5

### CORRECTIVE MAINTENANCE

5.1.	LIST OF FAULTS AND CORRECTIVE ACTIONS	5-4
5.2.	STATUS CODE LIST	5-14
5.3.	GENERAL CONNECTION DIAGRAM	5-16
Table 5-1 – List of faults and corrective actions		5-4

Page intentionally left blank

## 5. CORRECTIVE MAINTENANCE

Corrective maintenance must be performed by qualified personnel to intervene on the instrument from the information provided in this document.

The monitor automatically and continuously self-tests its main components. Any detected malfunction is indicated by a plain-language message on the display.

Table 5.1 summarizes the main faults indicated by the analyzer device and the possible actions to remedy.

### WARNING

- Refer to safety instructions CS1 to CS9.
- Particular radioprotection instructions.

## 5.1. LIST OF FAULTS AND CORRECTIVE ACTIONS

Table 5-1 – List of faults and corrective actions

Multiplexer channel alarms	Min	Max	Units	Timing
Display : <b>GND</b>	- 50	50	mV	60 s
Display : <b>+5 V</b>	4.75	5.25	V	60 s
Display : <b>+15 V</b>	14.5	15.5	V	60 s
Display : <b>-15 V</b>	- 15.5	-14.5	V	60 s
Display : <b>Ref. 2.5V</b>	2.45	2.55	V	60 s
Display: <b>Internal T.</b> <u>Possible action :</u> – Check that cabinet temperature or room temperature, where the analyzer is located, is really under normal use conditions.	5	55	°C	60 s
Display: <b>Up pr.</b> <u>Possible actions :</u> – When pump is OFF, check: Upstream pressure = Atmospheric pressure. If it is not the case: carry out sensor calibration. – Check for no obstruction in the fluid circuit. – Check for source-holder movement, and filter advance. – Change sensor if faulty.	400	1050	mbar	30 s
Display: <b>Down pr.</b> <u>Possible actions :</u> – When pump is OFF, check: Downstream pressure = atmospheric pressure. If it is not the case: carry out sensor calibration. – Check for no obstruction in the fluid circuit. – Check for source-holder movement, and filter advance. – Change sensor if faulty.	400	1050	mbar	30 s
Display: <b>Atmo. Pr.</b> <u>Possible actions :</u> – Check for no obstruction in the fluid circuit. – Change sensor if faulty.	900	1050	mbar	30 s



Multiplexer channel alarms	Min	Max	Units	Timing
Display : <b><i>HV Geiger (if active)</i></b> <u>Possible action :</u> – Replace the high voltage supply board C06-0493.	450	650	V	60 s

Communication alarms	Min	Max	Unité	Timing
Display : <b>Module board → Not linked</b>  NOTE : All the Mux channels at 0 or are frozen.  <u>Possible action :</u> – Switch OFF analyzer, then check for cable connections on module board and ARM20 board.	-	-	-	10 s

Flow alarms	Min	Max	Units	Timing
NOTE : These alarms are only activated when the pump is ON.				
Display : <b>Flow → Out of regulation</b>  <u>Possible actions :</u> – Remove cover and check correct operation of motor valve command in the first page of the « <i>Hardware function tests</i> » screen. Check that motor well drives valve when command is activated. If it is not the case tighten the 2 screws on hybrid seal.  – Check for fluid circuit tightness. – Check for no obstruction in the fluid circuit. – Carry out pump maintenance	- 1.5	+ 1.5	l/min	60 s

Various alarms	Min	Max	Units	Timing
Display : <b>Geiger life</b> NOTE : Mc = Million counts <u>Possible actions :</u> – Replacer GM detector if necessary. – Reset lifetime counter.	-	50000	Mc	-
Display : <b>Geiger → No activity</b> NOTE : This alarm is activated only during « Blank » countings. <u>Possible actions :</u> – Check for source-holder movement in activating motor in the first page of the « <i>Hardware function tests</i> » screen. Check that motor well drives source-holder when it is activated. If it is not the case: tighten the two screws on the hybrid seal. – Check GM detector supply voltage in the first page of the « <i>Hardware function tests</i> » screen. – Check GM detector operation with a mass test and a gauge test.			c/s	20 s
Display : <b>Gauge</b> NOTE : This alarm is activated only during « Blank » countings. <u>Possible actions</u> – Check for source-holder movement in activating motor in the first page of the « <i>Hardware function tests</i> » screen. Check that motor well drives source-holder when it is activated. If it is not the case: tighten the two screws on the hybrid seal. – Check GM detector supply voltage in the first page of the « <i>Hardware function tests</i> » screen. – Check GM detector operation with a mass test and a gauge test.	1000	9900	c/s	60 s
Display: <b>NRA count.</b> <u>Possible action :</u> – Check that source-holder is not blocked in « counting » position.	-	20	c/s	-
Display: <b>Contam.</b> <u>Possible action :</u> – Check that source-holder is not blocked in « counting » position.	-	30	c/s	-



Various alarms	Min	Max	Units	Timing
<p>Display : <b>Clogging</b></p> <p>NOTE : There is clogging when upstream pressure P1 is lower than <math>(750 \text{ mbar} \times P_{\text{atmospheric}}) / 1013 \text{ mbar}</math>.</p> <p><u>Possible actions :</u></p> <ul style="list-style-type: none"><li>– Check upstream and atmospheric pressure sensors.</li><li>– Remove the cover and check for correct operation of motor valve command in the first page of the « <i>Hardware function tests</i> » screen. Check that motor well drives when command is activated. If it is not the case: tighten the two screws on the hybrid seal.</li><li>– Check for no obstruction in the fluid circuit.</li><li>– Check for paper advance.</li></ul>		-	mbar	360 s

RST option alarms	Min	Max	Units	Timing
NOTE : RST option must not be « OFF » (see the second page of the « <i>Advanced analyser configuration</i> » screen)				
Display: <b>Atmo. T.</b> <u>Possible actions :</u> – Check sensor and ensure correct connection of RST line cables on analyzer rear panel. – Replace sensor if necessary.	– 30	80	°C	30 s
Display: <b>Rel. hyg.</b> <u>Possible actions :</u> – Check sensor and ensure correct connection of RST line cables on analyzer rear panel. – Replace sensor if necessary.	1	100	%	30 s
Display: <b>Head T.</b> <u>Possible actions :</u> – Check sensor and ensure correct connection of RST line cables on analyzer rear panel. – Replace sensor if necessary.	– 30	80	°C	30 s
Display : <b>Tube Condensation</b> NOTE : Alarm is activated if head temperature is lower than external dew-point. <u>Possible actions :</u> – Check heating control of RST line. – Modify regulation mode of RST line. – Check temperature setting of room air conditioning. This temperature must be lower than 26°C.		-	-	60 s
Display: <b>Head T. = f (Atmo T.)</b> NOTE : Alarm is activated if regulation setting of activated mode is not reached. <u>Possible actions :</u> – Check RST line sensors. – Check heating command of RST line.	– 2	3	°C	600 s

Display : <b>GM T. = f (D. point)</b> NOTE : Alarm activated if the regulation setpoint of the activated mode is not reached. <u>Possible actions</u> <ul style="list-style-type: none"><li>– Check the RST line sensors.</li><li>– Check the heating control of the RST line.</li></ul>	– 2	3	°C	600 s
Display : <b>Head T. = f (D. point)</b> NOTE : Alarm activated if the regulation setpoint of the activated mode is not reached. <u>Possible actions</u> <ul style="list-style-type: none"><li>– Check the RST line sensors.</li><li>– Check the heating control of the RST line.</li></ul>	– 2	3	°C	600 s

GM sensor alarms	Min	Max	Units	Timing
Display: <b>GM T.</b> <u>Possible actions :</u> – Check sensor. – Replace sensor if necessary.	– 30	80	°C	60 s
Display: <b>GM hydr.</b> <u>Possible actions :</u> – Check sensor. – Replace sensor if necessary.	1	100	%	60 s
Display: <b>GM pr.</b> <u>Possible actions :</u> – Check sensor. – Replace sensor if necessary.	400	1050	mbar	60 s
Display: <b>GM pr. → No sensor</b> <u>Possible actions :</u> – Check cable connecting GM sensor board to module board. – Stop-start the analyzer. – Replace sensor if necessary.	-	-	-	60 s
Display: <b>GM T. /Hygr. → No sensor</b> <u>Possible actions :</u> – Check cable connecting GM sensor board to module board. – Stop-start the analyzer. – Replace sensor if necessary.	-	-	-	60 s
Display : <b>GM condensation</b> NOTE : Alarm is activated if GM temperature is lower than external dew-point. <u>Possible actions :</u> – Check heating control of RST line. – Check temperature setting of room air conditioning. This temperature must be lower than 26°C.		-	-	60s



CPM option alarms	Min	Max	Units	Timing
NOTE : CPM option must be « ON » (in « CONFIGURATION ⇨ Measurement mode ») screen				
Display : <b>CPM module → Not linked</b> Possible actions : – Check that front panel switch of CPM is "ON". – Check that CPM is well connected by its cable to MP101M rear panel.	-	-	-	10 s
Display : <b>Optical sig. (if laser ON)</b> Possible actions : – In the first page of the « Hardware function tests » screen check that the laser diode is on and the CPM is detecting particles when the pump is « ON ». – Replace detector board.	0	6000	mV	60 s
Display :  <b>Laser I.</b> Possible actions : – Check that laser diode is well connected to the CPM main board. – Replace laser diode.	20	200	mA	60 s
Display :  <b>Laser I.</b> Possible actions : – Check room temperature. This temperature must be lower than 30°C. – Check lifetime counter of laser diode. If it is near 30000 h, that means the laser diode reaches its theoretical lifetime end. Laser diode must be replaced soon.	30	150	mA	60 s
Display : <b>Laser life</b> Possible actions : – Replace laser diode as soon as possible. – Reset lifetime counter.	-	30000	h	1 s
Display : « <b>CPM fact.</b> » Possible actions : – Check in the first page of the « Hardware function tests » screen that the laser diode is lit and that the CPM is detecting particles when the pump is « ON ».	0.01	500	-	1 s

Automatic span alarms	Min	Max	Units	Timing
NOTE : The automatic span option must be « ON » in the first page of the « <i>Advanced analyzer configuration</i> » screen.				
Display : <b>Auto. cal.</b> <u>Possible actions</u> – Check that the reference gauge is inserted correctly. – Perform a mass test.	– 10	+ 10	%	0 s
Display : <b>Mass cont.</b> <u>Possible actions</u> – Check that the reference gauge is inserted correctly. – Perform a Beta calibration.	– 25	+ 25	µg/cm <sup>2</sup>	0 s
Display : <b>Gauge cont.</b> <u>Possible actions</u> – Repeat a manual gauge test.	– 10	+ 10	µg/cm <sup>2</sup>	0 s

## 5.2. STATUS CODE LIST

The status code value includes two information:

- 1. Analyzer status during data storage (most significant bit).

The most significant bit value recorded corresponds to the sum of the activated status codes during the storage period:

Code (HEX)	Code (DEC)	Descriptions
00	0	Valid measurement
01	1	Invalid data (warm-up, analyzer stop...)
02	2	General alarm
04	4	Not used
08	8	Not used
10	16	Not used
20	32	Maintenance
40	64	Less than 2/3 of the measurements are valid
80	128	Warm-up
FF	255	Configuration change

HEX: Hexadecimal

DEC: Decimal

- 2. Measurement validity percentage (includes values of most significant bit and least significant bit).

Validity percentage calculation: (valid data number \* 100) / total data number.

Status code example:

Code (HEX)	Descriptions
0300	General alarm, Invalid data, validity: 0 %
005A	Measurement, validity: 90 %

Page intentionally left blank

5.3. GENERAL CONNECTION DIAGRAM



Page intentionally left blank